

FT-726R

YAESU MUSEN CO., LTD.

C.P.O. BOX 1500
TOKYO, JAPAN

CONTENTS

	(Page)
ERRATA FOR THE FT-726R OPERATING MANUAL	2
TOP AND BOTTOM COVER REMOVAL	3
SOLDERING AND DESOLDERING TECHNIQUE	4
UNIT LOCATIONS	7
SERVICE AND ALIGNMENT:	
POWER SUPPLY	8
VFO UNIT	9
TX UNIT	10
RX UNIT	11
SATELLITE UNIT (option).....	13
50 MHz MODULE (option).....	14
144 MHz MODULE	17
430 MHz AND 440 MHz MODULES (options).....	19
HF MODULE (option).....	22
COMPONENT APPLICATIONS	25
PARTS LAYOUTS, SCHEMATICS, AND VOLTAGE CHARTS:	
RX UNIT	34
TX UNIT	38
VFO UNIT	42
AF UNIT	45
SAT UNIT	46
AVR UNIT	50
DISPLAY UNIT	51
SCAN/SQL SW UNIT.....	52
SW UNITS A-H	53
FTS-32R AND FTE-36 TONE SQL UNITS	54
CONTROL UNIT	55
50 MHz MODULE	57
144 MHz MODULE	61
430 AND 440 MHz MODULES	65
10-15m MODULE.....	69
INTERCONNECTION DIAGRAM	73
BLOCK DIAGRAMS	74
FRONT PANEL EXPLODED VIEW	77
REAR PANEL EXPLODED VIEW	78
PARTS LIST	79



This manual is intended to serve as a technical supplement to the FT-726R Operating Manual. Detailed information regarding functions, installation, interconnections, operation, and installation of options has been provided in the Operating Manual, and is not reprinted herein. Therefore, this Technical Supplement is not intended to serve as an independent reference, but to be used in conjunction with the information provided in the Operating Manual.

Because there are over seven hundred semiconductor devices in the fully equipped FT-726R, circuit description information is provided in the form of numerous block diagrams and a complete Component Applications list. It is our hope that this manner of providing functional information will prove to be more convenient for the owner and technician than would a lengthy verbal description. Those readers who are not familiar with the basic types of analog and digital circuits that serve as the building blocks of the FT-726R are encouraged to study instructional material, such as that contained in handbooks on amateur radio and digital circuit design, before attempting to understand the design of the FT-726R. Each block in the block diagrams represents one such basic circuit, while the Component Applications list provides additional details for each semiconductor. Specific circuit details are provided in the schematic diagrams.

While we believe this technical information is correct and factual, Yaesu assumes no liability for damage that may result from typographical or other errors that may be present. Your cooperation in pointing out any inconsistencies in the technical information would be appreciated.

Yaesu Musen reserves the right to make changes in the circuitry of this transceiver, in the interest of technological improvement, without notification of the owner.

ERRATA FOR THE FT-726R OPERATING MANUAL

These corrections apply to early printings of the Operating Manual. Many have been included in later printings, but those manuals with edition numbers up to and including E3830183A (8307-D) should be corrected. The edition number is printed at the bottom of the rear cover of the manual.

Pages 2 and 3, Specifications:

The specifications for the 10–15m Module have been added in later printings, as follows:

10–15m Module Specifications

Frequency coverage:

- 21–21.49998 MHz
- 24.5–24.99998 MHz
- 28.0–29.99998 MHz

Repeater shifts:

- ±100 kHz for 28 MHz

Power input.

- 10–15m: 30W PEP/DC for 10W out

Spurious radiation:

- 10–15m: Better than –40 dB

Frequency stability:

- 10–15m: Better than ±10 ppm

Sensitivity:

- 10–15m SSB/CW
 - Less than 0.3 μ V for 10 dB (S+N)/N
- 10m FM
 - Less than 0.7 μ V for 12 dB SINAD

IF frequencies:

- 10–15m: 46.255 MHz
- 10.810 MHz
- 10.750 MHz
- 455 kHz

Channel steps:

- SSB, CW: 20/200 Hz
- FM: 10/20 kHz

Page 10, Meter I:

The first printing of the manual stated in this paragraph that Meter I indicates RF power output in watts. This should be corrected to relative forward power, with a deflection of “8” corresponding to 10W RF output into a 50-ohm resistive load.

Page 11, BURST

This paragraph describing the switch of the same name on the top panel has been amended to reflect the CW sidetone disable feature that has been added to this switch in later model transceivers: “when this switch is OFF, the CW sidetone is disabled to allow for easy searching for the down-link signal during CW operation through a satellite.”

Page 20, Step 5.

This paragraph has been amended to incorporate the correction on page 10, and should read,

“5. For simplex operation, simply press the PTT switch on the microphone to transmit on the same frequency. Advance the DRIVE control clockwise until the PO indication on Meter I just ceases to increase, while the ALC indication on Meter II remains in the safe ALC zone. Then advance the MIC GAIN while speaking into the microphone with a normal voice, to the point where the green BUSY LED flickers with speech. When adjusting the DRIVE control, PO deflection depends on the antenna impedance, and will be “8” for a 50-ohm resistive load. If the PO reading is less than “5”, the antenna is probably mismatched.”

Page 23, Step 2.

The fourth sentence, beginning with, “Of course, when the optional tone squelch . . .” should be deleted, if present.

Page 24, Step 5

Within the two double quotation marks in the fourth line from the bottom of the page, a backwards “C” should be printed, as it would appear on the digital display.

Page 25, second column

The following sentence has been added to the end of the first paragraph, "During CW operation, the BURST/TONE switch on the top cover may be set to the OFF position to disable the sidetone, allowing easy location of the carrier on the downlink."

Page 28, Step 5.

The numbers of the lowest set of jacks should be J₃₀₀₇, J₃₀₀₈ and J₃₀₀₉, instead of J₃₀₁₃, J₃₀₁₄ and J₃₀₁₅, as appeared in the first printing of the manual. Also, in later printings, the numbers of all nine jacks have been added to the diagram of the AF Unit below the text, with J₃₀₁₀, J₃₀₁₁ and J₃₀₁₂ marked on the middle set of jacks, from left to right, and J₃₀₀₇, J₃₀₀₈ and J₃₀₀₉ in the lower Default position.

Page 34, TX Unit Schematic Diagram:

The three 2SA733Q transistors at the lower left corner should be Q₁₉, Q₂₁ and Q₂₂. Q₁₉ was misprinted to appear as Q₁₃.

Also on this diagram, near quad AND gate IC Q₃₅ at the lower right, The diode below diode D₄₃ should be labelled D₄₄. It was misprinted as D₀₄.

Page 35, RX Unit Schematic Diagram:

The type 2SC945P transistor near the upper right corner that is labelled as Q₃₀ should be labelled Q₃₂. Q₃₀ is the type 2SC1815GR transistor between Q₂₉ and Q₃₁ below Q₃₂.

Page 37, 6m Module Schematic Diagrams:

In the RF Unit diagram, the collector of Q₀₉ should be shown connected to the junction of C₈₈ and R₅₂, in addition to the connections shown.

In the PLL Unit diagram, the crystal oscillator transistor near the lower left should be labelled Q₆₀₂₀ (2SC945P). Also in this diagram, at the lower right, D₂₀, D₂₂, D₂₄ and D₂₆ should be deleted.

Page 38, 2m Module Schematic Diagrams:

In the PLL Unit diagram, diodes D₂₁ and D₂₂ at the lower right should be removed. Also, it should be indicated that all part location numbers on this Unit are preceded by the number 6.

Page 39, 70cm Module Schematic Diagrams:

In the 70cm Power Amp Unit diagram at the upper left, diode D₀₂ should be shown with the anode connected to ground.

In the PLL Unit diagram, the test point immediately beneath pins 1 and 2 of Q₂₃ in the lower center of the diagram should be labelled TP₀₇, and diode D₂₀ should be removed from the right side of the diagram.

Block Diagrams:

Numerous corrections have been made to the block diagrams printed at the end of the Operating Manual. These corrections have been incorporated into the block diagrams on pages 74, 75 and 76 of the Technical Supplement.

TOP AND BOTTOM COVER REMOVAL

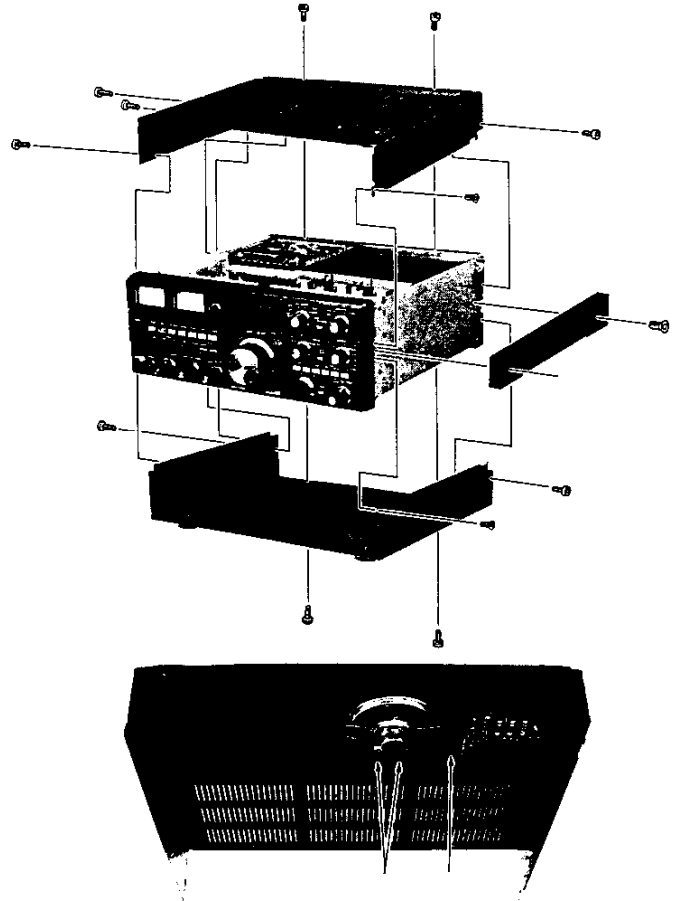

Note:

When removing the top cover, disconnect the cables to the speaker and SCAN/SQL Unit before pulling the cover away.

Remember to reconnect these cables when replacing the cover.

SOLDERING AND DESOLDERING TECHNIQUE

SOLDERING AND DESOLDERING TECHNIQUE ON PRINTED CIRCUIT BOARDS

The FT-726R circuit boards are tough, but mishandling during soldering can cause circuit traces to "lift." While this does not cause permanent damage to the board, much servicing trouble can result, because of the tendency for this lifted trace to break. A few simple precautions will keep your circuit boards in A-1 condition.

1. Use only a 12 to 30-watt chisel-tip soldering iron, with the tip grounded or isolated from AC and DC potential. Voltage at the tip can easily destroy CMOS components.
2. Use only the minimum amount of heat necessary to remove a component, or to cause the solder to "flow" when installing a new component.
3. USE ONLY 60/40 ROSIN CORE SOLDER.
4. Use solder removing braid and flux to absorb excess solder before installing a new component. A solder sucker can also be used, but must be handled with care to avoid lifting traces.
5. Do not attempt to remove DIP ICs without first cutting all of the pins on the component side of the board, unless you have the correct and all-pin desoldering tip).

If you do lift a trace, don't worry! Read on to find out how to repair traces like a pro.

NOTES ON USE OF CMOS COMPONENTS:

As CMOS devices are extremely sensitive to damage from static electricity, special precautions must be observed.

In storage, use only conductive sponge specially designed for CMOS components.

When installing a CMOS part in a socket, or on a circuit board, be certain that the power is off. In addition, the technician should rest his hand on the chassis as the component is inserted, so as to place his hand at the same potential as the chassis (better to discharge small amounts of static electricity through your fingers than through a \$5 IC!).

When soldering a CMOS part onto a circuit board, use a low-wattage iron, and be sure to ground the tip with a clip lead, if the tip is not grounded through a three-wire power cord.

FOR SERVICE MANUALS
CONTACT:
MAURITRON TECHNICAL SERVICES
www.mauritron.co.uk
TEL: 01844 - 351694

INSERTION OF PARTS ON CIRCUIT BOARDS

All of the below are acceptable ways of inserting components into circuit board mounting holes.



(a) Bend leads slightly



(b) Straight-in mounting

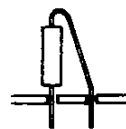

(c) Vertical mounting

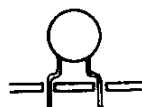

(d) Preformed disc ceramic capacitor



(e) Preformed resistor, diode, etc.

BASIC SOLDERING PRACTICE

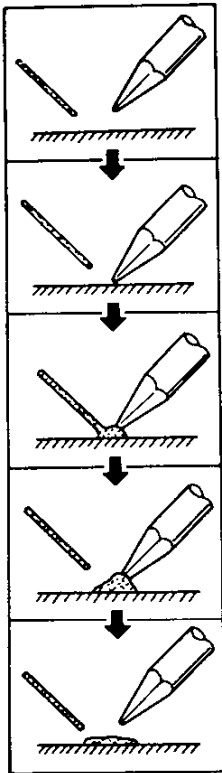

- (1) Prepare soldering iron and solder. The tip of the iron should be thoroughly tinned and wiped clean of excess solder.
- (2) Apply soldering iron to surface to be soldered. Do not press the iron into the surface.
- (3) Apply solder to junction of iron and heated surface.
- (4) When enough solder is applied, remove solder. Continue to apply heat just until solder flows cleanly.
- (5) Remove iron from work. Do not apply more heat than necessary for good solder flow.

EXAMPLES OF POOR SOLDERING PRACTICE

Unwanted solder bridge connecting two tracks (caused by use of too much solder)

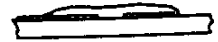

"Cold joint" (caused by insufficient heat to part of work, resulting in poor solder flow)

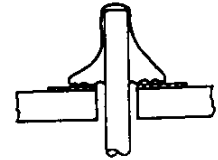

Unstable joint (caused by insufficient heat or solder)

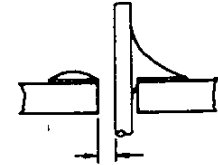

Proper soldering:

A smooth fillet of solder surrounds the lead and just covers the foil pad.

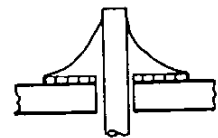

Soldering to terminal posts:

(Be certain to apply heat to both post and wire.)

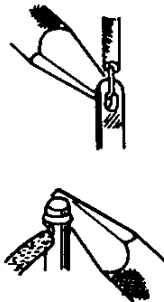
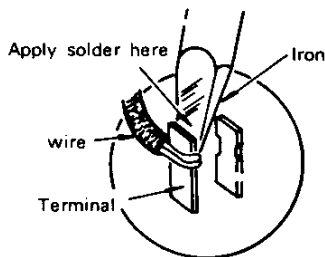

Repair of a "lifted" trace:

If you have previously lifted a trace, make an etch cut on each side of the lifted trace as shown in the drawing, and install a wire bridge.

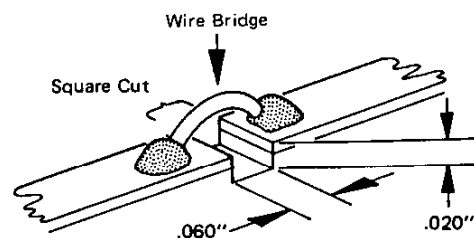
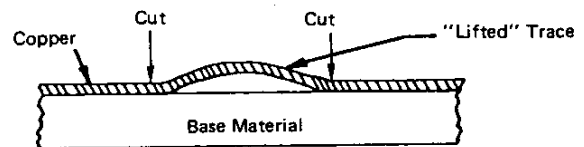

Coat Cut Area With Eastman 910
After Soldering Wire Bridge

TYPICAL PART FAILURES, CAUSES AND SYMPTOMS

PARTS	CAUSE OF TROUBLE	SYMPTOMS
Semiconductors (IC, FET, TR)	High supply voltage Open circuit Excessive drive High temperature	Short or open circuit Output decreases to 1/2 at 80°C Internal noise Instability
MOS FET MOS IC	Static electricity	Total failure Short or open circuit
Crystal Crystal filter	Shock High temperature Aging	No oscillation Off frequency Frequency drift Filter bandpass change
Resistor	Excessive power High temperature	Component burned Value changed Open circuit
Potentiometer	Excessive power Shock Dust or oil Wear	Component burned Open circuit Noise Unsmooth rotation
Capacitor	Excess voltage High temperature Aging	Shorted Leakage Open/decreased capacitance
Variable capacitor Trimmer capacitor	Ratings exceeded Dust between plates Shock, forced rotation	Shorted Leakage Unsmooth rotation
Coils	Ratings exceeded Misadjusted Core or bobbin broken	Open or short circuit Leakage or shorted turns Detuned
Switch	Ratings exceeded Aging Dust or oil	Poor contact Unsmooth operation Open circuit
Relay	Ratings exceeded Humidity Dust or oil on contacts	Coil open Poor or intermittent contact Noise

FOR SERVICE MANUALS
CONTACT:
MAURITRON TECHNICAL SERVICES

UNIT LOCATIONS

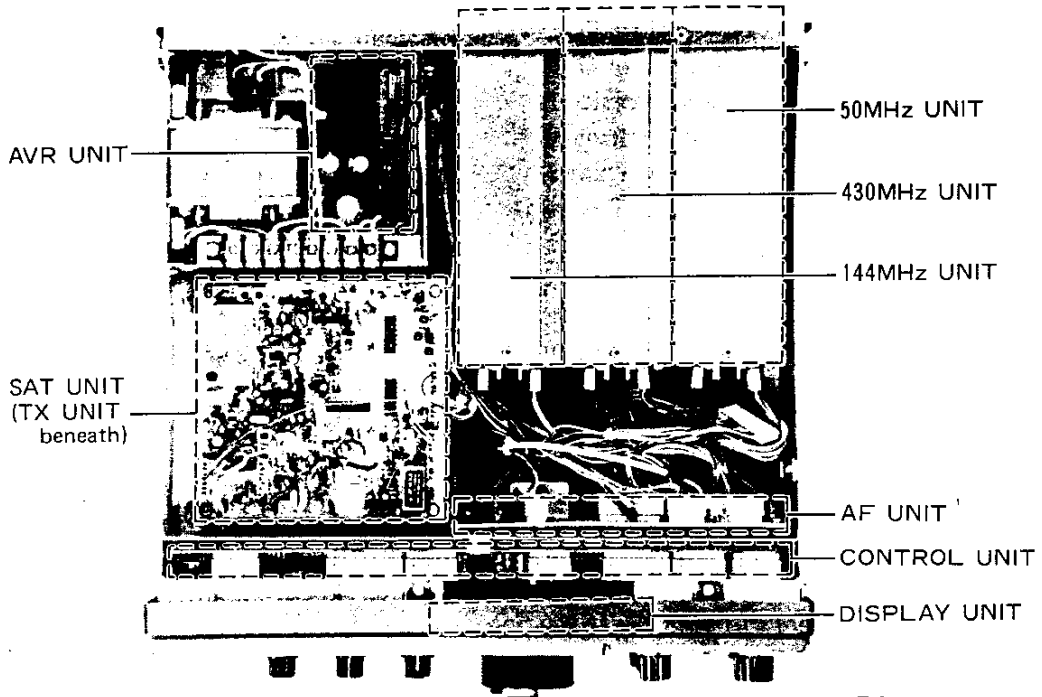

TOP VIEW

FOR SERVICE MANUALS
CONTACT:
MAURITRON TECHNICAL SERVICE

www.mauritron.co.uk
TEL: 01844 - 351694
FAX: 01844 - 352554

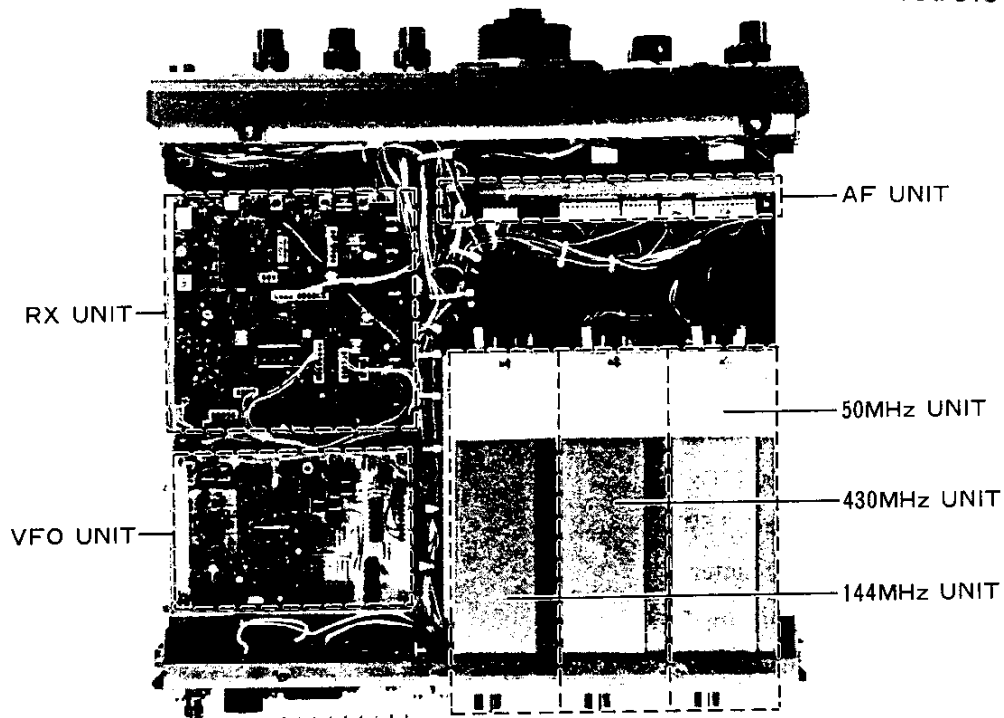

BOTTOM VIEW

SERVICE AND ALIGNMENT

Under normal operating conditions, the FT-726R may require realignment every few years, because of normal component aging. Such realignment should not require more than a very slight adjustment of the coils and trimmers, and a major shift in an adjustment point will probably result in misalignment. The original alignment performed at the factory is very precise, and coarse realignment will only be required in rare cases of component replacement.

Do not attempt any realignment of any circuit without first becoming fully familiar with the design and function of the entire transceiver. Many adjustments interact, and performance can be impaired by attempts to make random adjustments, or to align the transceiver without the proper test equipment and understanding of its use. If the equipment is not available, or if the circuitry is not clearly understood, please contact your Yaesu dealer for instructions on where to send the transceiver for realignment or servicing.

All alignment steps involving transmission require the connection of a 50-ohm non-reactive dummy load to the ANT jack of the appropriate Band Module, unless otherwise noted. The 144 MHz Module is used for all steps, unless otherwise noted.

Test Equipment:

Spectrum analyzer with coverage to 500 MHz

RF signal generator with coverage to 500 MHz, calibrated output and modulation

RF voltmeter ranging from 5 mV to 3V, with 5% accuracy to 500 MHz

Frequency counter with 0.1 ppm accuracy to 500 MHz

DC voltmeter with at least 10 Megohms impedance

In-line wattmeter accurate to 500 MHz

50-ohm non-reactive dummy load (15W)

FM Deviation meter and SINAD meter

Sampling coupler "T" (branch attenuator)

AF signal generator with adjustable output from 0.5 to 100 mV

AF voltmeter

Monitor receiver (SSB) covering the amateur bands of interest

Sweep generator covering 20–30 MHz

DC milliammeter

Oscilloscope

Preliminary Procedure

Alignment must be performed in a temperature-stable environment where the ambient temperature is between 20°C and 30°C. If the transceiver is brought from a different environment, allow at least one hour for the transceiver temperature to stabilize before applying power.

Once power is applied, allow at least five minutes for the oscillators to stabilize. Also, make sure that the test equipment is given the warmup time required for each item.

Alignment of the PLL VCVs (Varactor Control Voltages) require that the shield covers of the PLLs be in place. Signal levels expressed in dB μ assume a reference of 0 dB μ = 0.5 μ V across infinite impedance.

POWER SUPPLY

A. Supply Voltage

Connect the DC voltmeter between the 13.8V terminal on the AVR Unit and chassis ground. Adjust VR₇₀₁ for 13.8V on the meter.

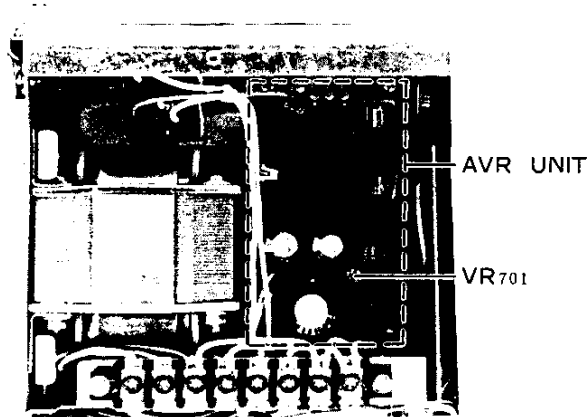

VFO UNIT

A. Local Oscillator

1. Connect the frequency counter to TP₁₀₁, and check for 4.5056 MHz \pm 100 Hz.
2. Connect the RF voltmeter to TP₁₀₂ and adjust T₁₀₄, T₁₀₅ and T₁₀₆ for peak RF voltage (min. 500 mVrms).

B. VCV

1. Tune the transceiver so that the display indicates xxx.x99.9 (x = any digit). Connect the DC voltmeter to TP₁₀₃ and adjust TC₁₀₁ for 6.5V on the meter (shield cover in place).
2. Retune the transceiver to indicate xxx.x00.0, and check for 3.0 to 4.0V on the meter.

C. VFO Output Level

Set the transceiver to indicate xxx.x50.0, and connect the RF voltmeter to pin 1 of J₁₀₂. Adjust T₁₀₁ - T₁₀₃ for peak RF voltage (min. 50 mVrms).

D. Channel Step Calibration

1. Set the transceiver to the FM mode, FM-CH function ON, and the STEP button in the OUT position. Tune for a display frequency of xxx.x50.0.
2. Connect the frequency counter through a 0.01 μ F capacitor to pin 1 of J₁₀₂, and now select the LSB mode. Adjust TC₁₀₃ for 7.835000 MHz on the counter.
3. Press the DOWN button to step the frequency 100 Hz lower on the display, and adjust TC₁₀₂ for 7.834980 MHz on the counter.
4. Press the UP button to return to the original display frequency, and repeat the adjustment in step 2. Repeat step 3, and then steps 2 and 3 again until no further adjustment is required.

FOR SERVICE MANUALS
CONTACT:
MAURITRON TECHNICAL SERVICES
www.mauritron.co.uk
TEL: 01844 - 351694
FAX: 01844 - 352554

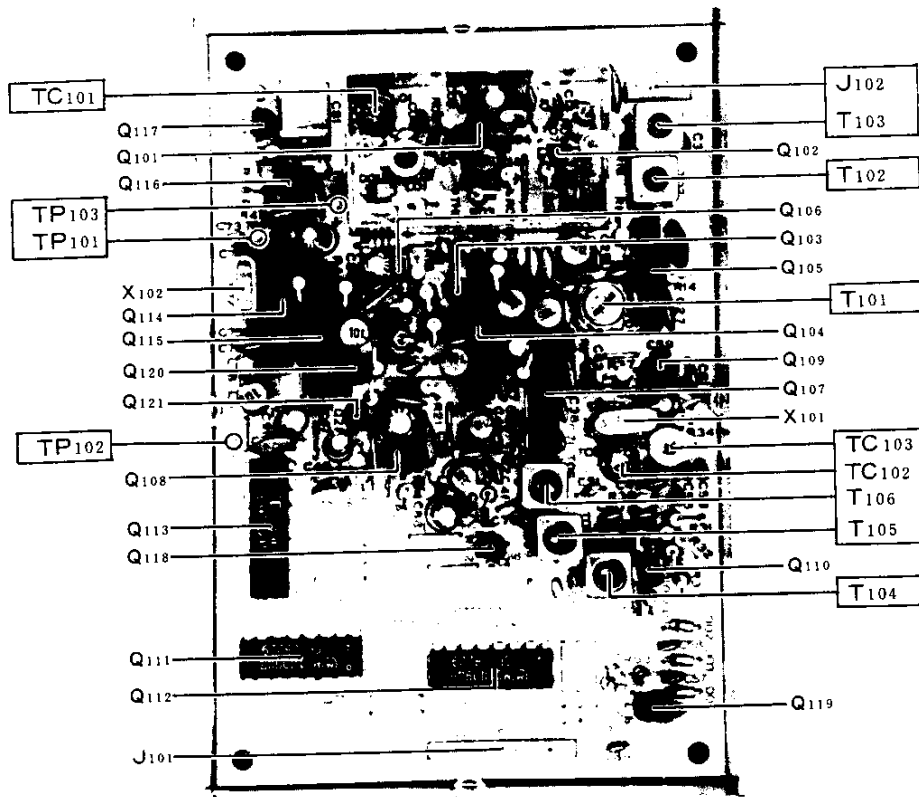

VFO UNIT

TX UNIT

A. ALC Meter

With the MIC GAIN control fully counterclockwise and in the USB mode, close the PTT line and adjust VR₁₀₀₆ to the threshold point where ALC indication just begins.

B. CW, FM Carrier Point

1. Connect the wattmeter with the dummy load to the 144 MHz ANT jack. Select the CW mode, and then close the PTT line and adjust T₁₀₀₂ and T₁₀₀₃ for maximum power on the wattmeter, adjusting the DRIVE control, if necessary, so that the ALC meter does not deflect.
2. Connect the frequency counter to pin 1 of J₁₀₀₁. Close the PTT line and adjust TC₁₀₀₂ for 10.809200 MHz \pm 50 Hz on the counter.
3. Now select the FM mode, and adjust T₁₀₀₁ for 10.810000 MHz \pm 100 Hz on the counter.

C. FM Modulator

1. Couple the deviation meter through a sampling coupler or attenuator to the ANT jack. Connect the AF generator to pin 8 of the MIC jack, and set for 15 mV output at 1 kHz. Select the FM mode, close the PTT line, and adjust VR₁₀₀₂ for \pm 4.5 kHz deviation.
2. Disconnect the AF generator, and set the MIC GAIN control fully counterclockwise. Press the CALL button and adjust VR₁₀₀₉ for \pm 3.0 kHz deviation.

D. SSB Carrier Point

(If the ALC meter deflects during this procedure, reduce the setting of the DRIVE control.)

1. Preset VR₁₀₀₁ to the center of its range. Connect the AF generator to pin 8 of the MIC jack, and set for 0.5 mV output at 2800 Hz. Set the transceiver to USB, close the PTT line, and note the output power on the wattmeter.

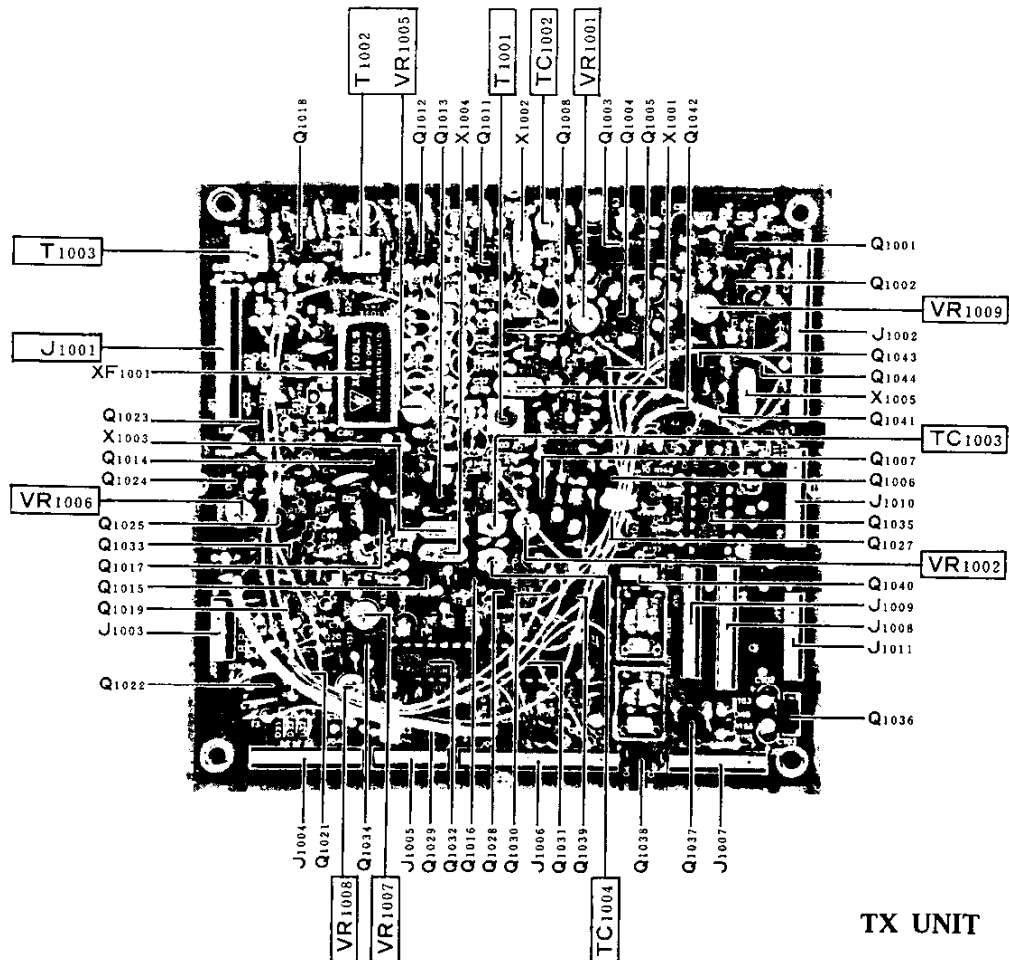

TX UNIT

2. Retune the AF generator to 300 Hz while maintaining the same generator output level, and adjust TC₁₀₀₄ for the same transceiver output level on the wattmeter.
3. Return to receive, select the LSB mode, and repeat the two previous steps, adjusting TC₁₀₀₃ until the power output is the same at both audio frequencies.

E. CW Sidetone Level

Connect the AF voltmeter across the speaker terminals, set VR₁₀₀₇ to the center of its range, and select the CW mode. Close the PTT line and adjust VR₁₀₀₈ for 150 mVrms on the voltmeter.

F. FM Modulation Indicator Check

Select the FM mode, and set the AF generator for 0.5 mV at 1 kHz to the MIC jack. Set the MIC GAIN control to the 12 o'clock position, close the PTT line, and check to see that the BUSY LED (indicating FM modulation) is lit.

G. SSB Carrier Balance

1. Set the MIC GAIN control and VR₁₀₀₁ fully counterclockwise, and set the mode to USB. Set the external monitor receiver to the transceiver frequency, close the PTT line, and adjust VR₁₀₀₅ for minimum signal strength in the external receiver.
2. Switch to LSB, key the transmitter, and observe the signal strength at the external receiver. Then switch back to USB and again key the transmitter and observe the signal strength. If the signal strength is different in the different modes, adjust VR₁₀₀₅ and repeat this step until the strength is about the same in both USB and LSB.
3. Switch to FM, close the PTT line, and set the DRIVE control so that the ALC meter deflects just to the right edge of the ALC zone (mid-scale). Set the AF generator for 15 mV output at 1 kHz. Switch to USB, close the PTT line, and adjust VR₁₀₀₁ so that the ALC meter again deflects to the right edge of the ALC zone.

H. Tone Burst Check

Set the mode for FM, and with the external receiver tuned to the same frequency as the transceiver, press the CALL button and listen for a 0.5-second tone.

RX UNIT

A. IF Bandpass Filters

Connect the signal generator to the ANT jack, and set for ± 3.5 kHz FM deviation. Tune the generator and transceiver to 146.000000 MHz, and set the generator output level for slight deflection of the S-meter. (If operation is limited to between 144 and 146 MHz, use 145 MHz for alignment.) Adjust T₂₀₀₁ and T₂₀₀₂ for maximum S-meter deflection.

B. Second Local Oscillator

1. Connect the frequency counter to TP₂₀₀₂. Set the transceiver to USB and adjust T₂₀₀₅ for 11.2650 MHz on the counter.
2. Connect the frequency counter to TP₂₀₀₁ and adjust T₂₀₁₂ for 11.2050 MHz on the counter.

C. IF Coils and S-Meter

1. With the signal generator and transceiver tuned as in part A, with no modulation and the transceiver set to USB, adjust T₂₀₀₃, T₂₀₀₄, T₂₀₀₆ and T₂₀₀₈–T₂₀₁₁ all for peak indication on the S-meter.
2. Remove the signal generator from the ANT jack, and listen to the receiver noise while switching from USB to LSB and back. Adjust T₂₀₀₅, if necessary, until the noise is about the same pitch.
3. Connect the signal generator to the ANT jack, and set for an output level of 20 dB μ at 146.000 (or 145.000) MHz. With the transceiver tuned to the same frequency, preset VR₂₀₀₂ to midrange, and adjust VR₂₀₀₅ for S9 deflection on the S-meter.
4. Increase the generator output to 80 dB μ and adjust VR₂₀₀₄ for S9+60dB on the meter.
5. Repeat the adjustments of steps 3 and 4 several times.

6. Set the transceiver to FM, and set the generator for 60 dB μ output with ± 3.5 kHz FM deviation. Adjust VR₂₀₀₃ for full-scale S-meter deflection.
7. Decrease the generator output to 20 dB μ and adjust VR₂₀₀₁ for S9+30dB on the S-meter.
8. Adjust VR₂₀₀₇ for center indication on the DISC meter (Meter I). Then remove the generator from the ANT jack, and note whether the DISC meter indication settles to the center. If not, adjust T₂₀₀₇ so that it does.

D. Noise Blanker

Connect the signal generator to the ANT jack, and set the output level for 30 dB μ at 145.5 MHz. Connect the DC voltmeter to the lead of R₂₁₂₄ on the RX Unit, and adjust T₂₀₁₄ – T₂₀₁₆ for minimum DC voltage on the meter.

E. Squelch Preset

1. Remove the generator from the ANT jack, set VR₂₀₀₈ fully clockwise, and set the SQL control to the threshold point where the noise is just silenced in the FM mode. The SQL control position should be between 8 and 9 o'clock.
2. Set the mode to USB, and the SQL control to the 9 o'clock position. Adjust VR₂₀₀₆ to the threshold point while receiving only noise.

FOR SERVICE MANUALS
CONTACT:
MAURITRON TECHNICAL SERVICES
www.mauritron.co.uk
TEL: 01844 - 351094
FAX: 01844 - 352554

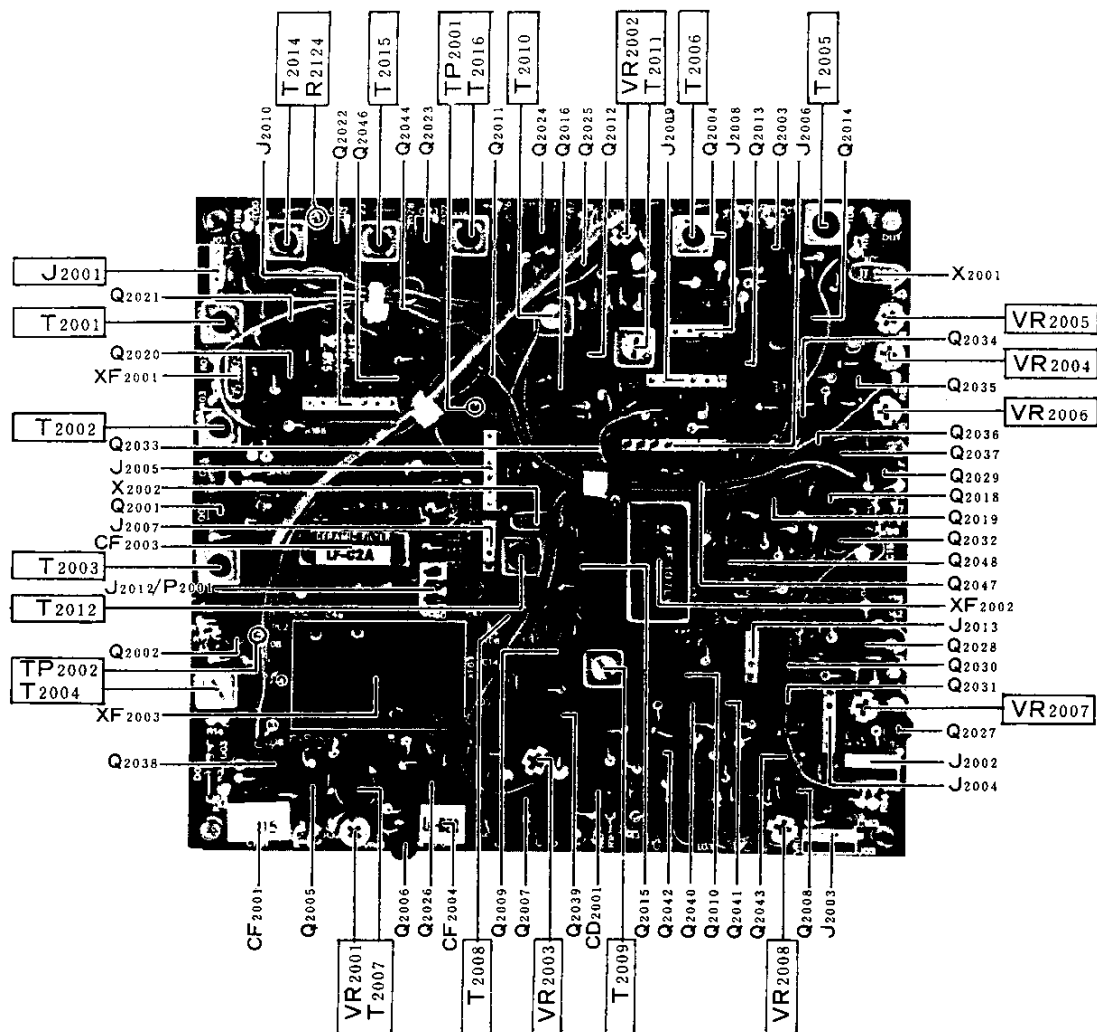

RX UNIT

SATELLITE UNIT (Option)

(Set the SATELLITE selector to RX)

A. Local Oscillator

1. Connect the frequency counter to TP₄₀₀₁, and check for 4.5056 MHz \pm 100 Hz.
2. Connect the RF voltmeter to TP₄₀₀₂ and adjust T₄₀₀₃, T₄₀₀₆, T₄₀₀₇ and T₄₀₀₈ for peak RF voltage (min. 700 mVrms).

B. VCV

1. Tune the transceiver so that the display indicates xxx.x99.9. Connect the DC voltmeter to TP₄₀₀₃ and adjust TC₄₀₀₅ for 6.5V on the meter (shield cover in place).
2. Retune the transceiver to indicate xxx.x00.0, and check for 2.5–3.5V on the meter.

C. VFO Output Level

Set the transceiver to indicate xxx.x50.0, and connect the RF voltmeter to pin 1 of J₄₀₀₆. Adjust T₄₀₀₃–T₄₀₀₅ for peak RF voltage (min. 50 mVrms).

D. Channel Step Calibration

1. Set the transceiver to the FM mode, FM-CH function ON, and the STEP button in the OUT position. Tune for a display frequency of xxx.x50.0.
2. Connect the frequency counter through a 0.01 μ F capacitor to pin 1 of J₄₀₀₆, and now select the LSB mode. Adjust TC₄₀₀₆ for 7.945000 MHz on the counter.
3. Press the DOWN button to step the frequency 100 Hz lower on the display, and adjust TC₄₀₀₇ for 7.944980 MHz on the counter.

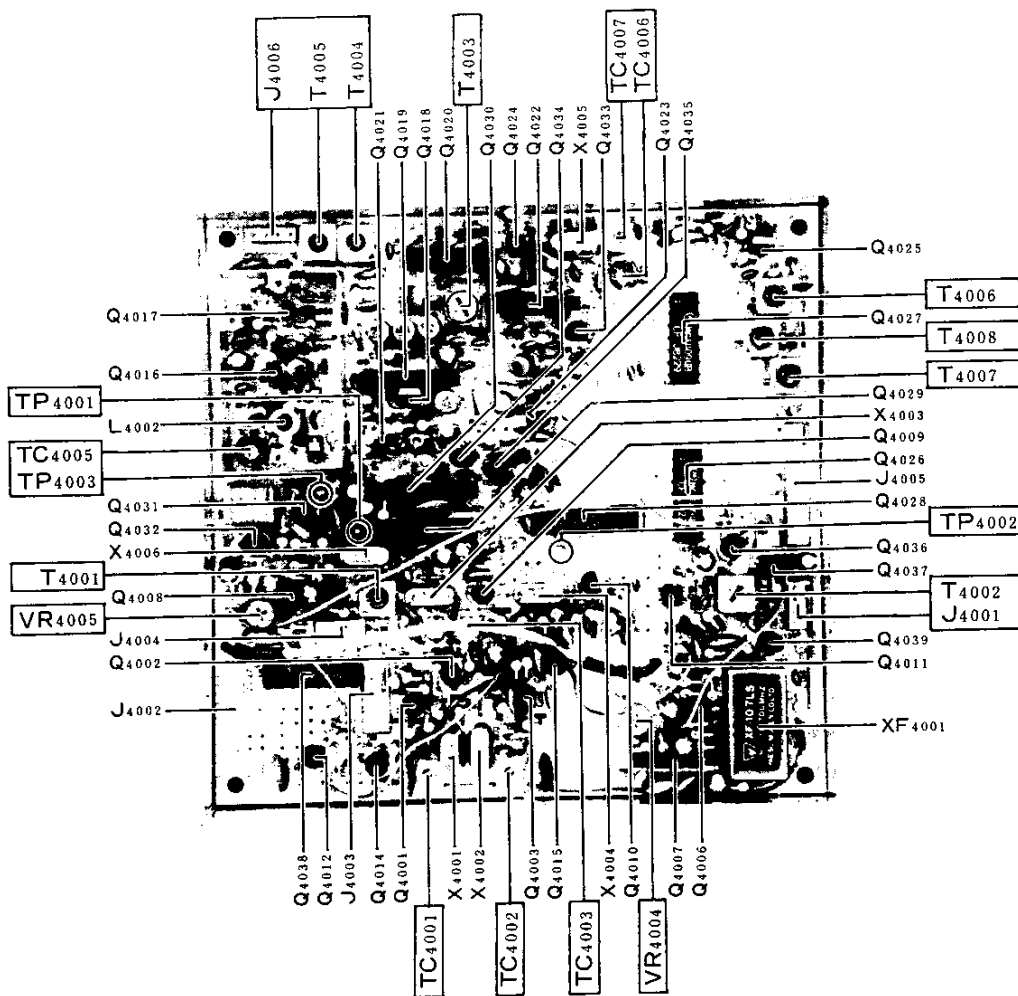

SAT UNIT

4. Press the UP button to return to the original display frequency, and repeat the adjustment in step 2. Repeat step 3, and then steps 2 and 3 again until no further adjustment is required.

E. CW, FM Carrier Point

(Set the SATELLITE selector to TX)

1. Connect the RF voltmeter to pin 2 of J₄₀₀₁, and select the CW mode. Close the PTT line and adjust T₄₀₀₂ for maximum RF voltage on the meter.
2. Connect the frequency counter through a 0.01 μ F capacitor to pin 2 of J₄₀₀₁. Close the PTT line, and adjust TC₄₀₀₃ for 10.699200 MHz on the counter.
3. Switch to the FM mode, close the PTT line, and adjust T₄₀₀₁ for 10.700000 MHz on the counter.

F. FM Modulator

Couple the deviation meter through a sampling coupler or attenuator to the ANT jack. Connect the AF generator to pin 8 of the MIC jack, and set for 15 mV output at 1 kHz. Select the FM mode and set the MIC GAIN control to midrange. Close the PTT line and adjust VR₄₀₀₅ for ± 4.5 kHz deviation on the meter.

G. SSB Carrier Point

(If the ALC meter deflects during this procedure, reduce the setting of the DRIVE control.)

1. Set the mode to USB. Connect the RF voltmeter to pin 2 of J₄₀₀₁, and set the AF generator (at the MIC jack) for 0.5 mV output at 2800 Hz. Close the PTT line and note the RF voltage on the meter.
2. Retune the AF generator to 300 Hz while keeping the same output level, and adjust TC₄₀₀₂ to obtain the same RF level as noted in step 1.
3. Return to receive and switch to LSB. Repeat steps 1 and 2, adjusting TC₄₀₀₁.

H. SSB Carrier Balance

1. With the dummy load and wattmeter connected to the ANT jack, set the MIC gain control fully counterclockwise and the mode to USB. Tune the external receiver to the transceiver frequency, close the PTT line, and adjust VR₄₀₀₄ for minimum signal strength at the external receiver.
2. Switch to LSB, key the transmitter, and observe the signal strength at the external receiver. Then switch back to USB and again key the transmitter and observe the signal strength. If the signal strength is different in the different sideband modes, adjust VR₄₀₀₄ and repeat this step until the strength is about the same in both USB and LSB.

50 MHz MODULE (Option)

A. PLL

(If the optional SATELLITE Unit is installed, it must be switched OFF for all except step 3, which does not need to be performed if the SATELLITE Unit is not installed.)

1. Connect the frequency counter to pin 12 of Q₆₀₂₁, and adjust TC₆₀₀₃ for 3.200000 MHz on the counter.
2. Tune the transceiver for a display of 5x.x50.0, and connect the RF voltmeter to pin 5 of Q₆₀₁₆. Adjust T₆₀₀₆ for maximum RF voltage on the meter.
3. Set the SATELLITE selector to TX, and adjust T₆₀₀₅ for maximum RF voltage on the meter. Then set the SATELLITE selector OFF.
4. Tune the transceiver for a display of 53.990.0. Connect the RF voltmeter to TP₆₀₀₂, and adjust T₆₀₀₃ and T₆₀₀₄ for peak RF voltage. Move the RF voltmeter to TP₆₀₀₁ and peak T₆₀₀₇–T₆₀₁₁. Now connect the RF voltmeter to TP₆₀₀₄ and peak each of the above transformers again, which should result in a final reading of approximately 700 mVrms on the meter.

C. Transmitter Section

1. Connect the wattmeter, dummy load and spectrum analyzer to the 50 MHz ANT jack. Preset VR₅₀₀₄ and VR₅₀₀₆ fully counterclockwise.
2. Tune the transceiver to 52.050.0 MHz, FM mode. Close the PTT line and adjust T₅₀₁₀ – T₅₀₁₅, TC₅₀₀₁ and TC₅₀₀₂ for maximum power output on the wattmeter.
3. Tune the transceiver to 50.000.0 MHz and adjust VR₅₀₀₄ so that the ALC meter deflects to the right edge of the safe ALC zone (corresponding with S9 on the S-meter scale).
4. Tune the transceiver to 52.000.0 MHz and adjust VR₅₀₀₆ for 10 watts output on the wattmeter.
5. Adjust VR₅₀₀₅ so that the PO meter indicates “8” on the PO scale of Meter I.
6. Repeat steps 4 and 5 several times.
7. Adjust VR₅₀₀₃ for minimum level of the spurious signals 10.81 MHz either side of the transmitter carrier.

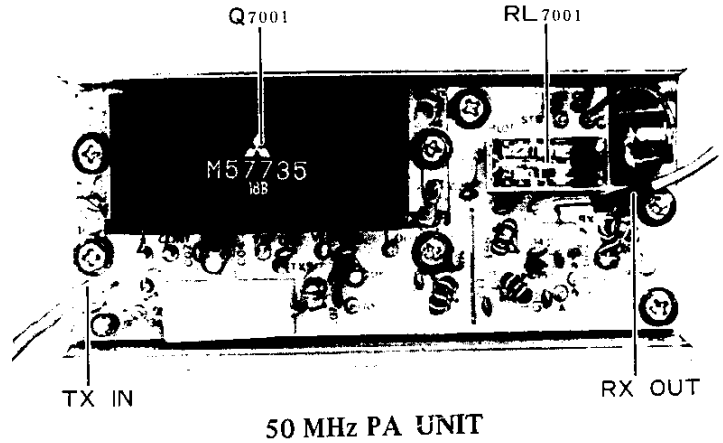

50 MHz PA UNIT

FOR SERVICE MANUALS
CONTACT:
MAURITRON TECHNICAL SERVICES

www.mauritron.co.uk
TEL: 01844 - 351694
FAX: 01844 - 352554

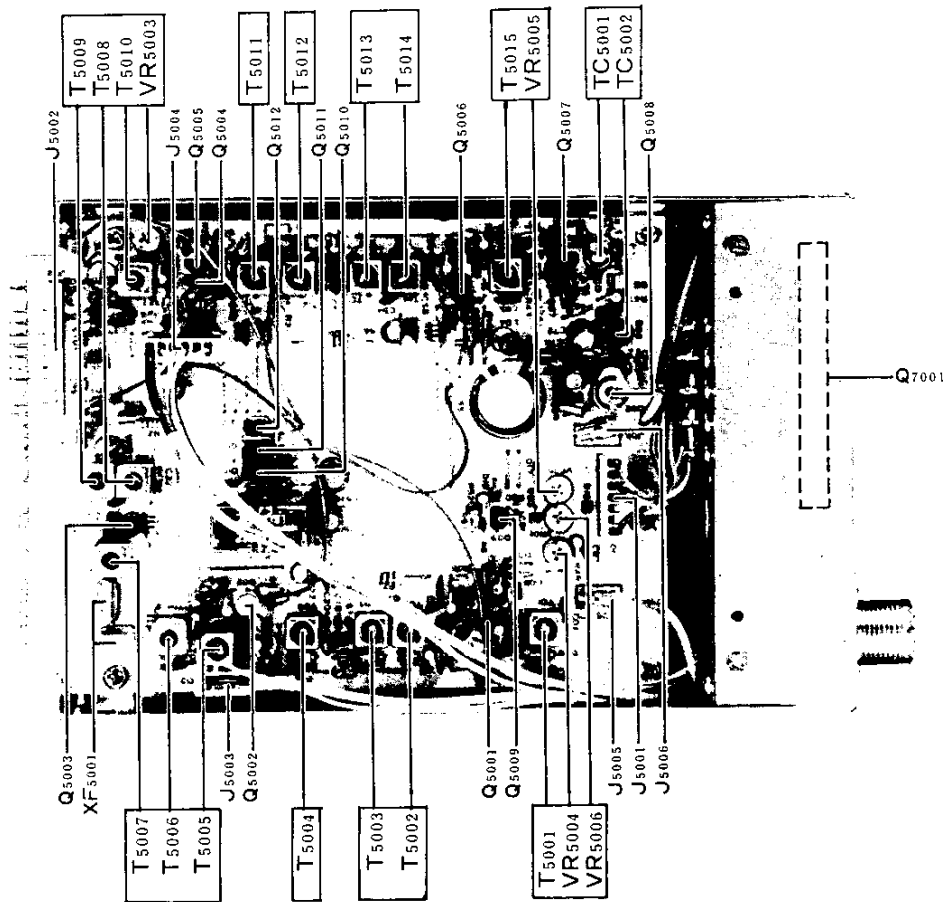

50 MHz RF UNIT

144 MHz MODULE

A. PLL

(If the optional SATELLITE Unit is installed, it must be switched OFF for all except step 3, which does not need to be performed if the SATELLITE Unit is not installed.)

1. Connect the frequency counter to pin 12 of Q₆₀₂₁, and adjust TC₆₀₀₃ for 3.200000 MHz on the counter.
2. Tune the transceiver for a display of 14x.x50.0, and connect the RF voltmeter to pin 5 of Q₆₀₁₆. Adjust T₆₀₀₆ for maximum RF voltage on the meter.
3. Set the SATELLITE selector to TX, and adjust T₆₀₀₅ for maximum RF voltage on the meter. Then set the SATELLITE selector OFF.
4. Tune the transceiver for a display of 147.990.0 (or 145.990.0 if 146 MHz is the upper limit of operation). Connect the RF voltmeter to TP₆₀₀₄ and adjust T₆₀₀₃, T₆₀₀₄ and T₆₀₀₇–T₆₀₁₁ for maximum RF voltage on the meter (nom. 700 mVrms).
5. If transceiver operation is not limited to below 146 MHz, perform this step. Otherwise, skip to step 6. Connect the DC voltmeter (10V range) to TP₆₀₀₃. Tune the transceiver for a display of 147.990.0 and adjust TC₆₀₀₁ for 6.2V on the meter. Retune the transceiver to 146.000.0 MHz and check for 1.5–3.0V on the meter.
6. Connect the DC voltmeter (10V range) to TP₆₀₀₃, and tune the transceiver for a display of 145.990.0. Adjust TC₆₀₀₂ for 6.2V on the meter. Retune the transceiver to 144.000.0 MHz and check for 2.5–4.0V on the meter.
7. Connect the RF voltmeter to the cathode of D₆₀₀₆ and tune the transceiver for display of 145.500.0. Close the PTT line and adjust T₆₀₀₁ for maximum RF voltage.
8. Connect the frequency counter to TP₆₀₀₂, and tune the transceiver to 145.000.0 MHz, FM mode. Adjust T₆₀₀₂ for 134.190000 MHz on the counter.

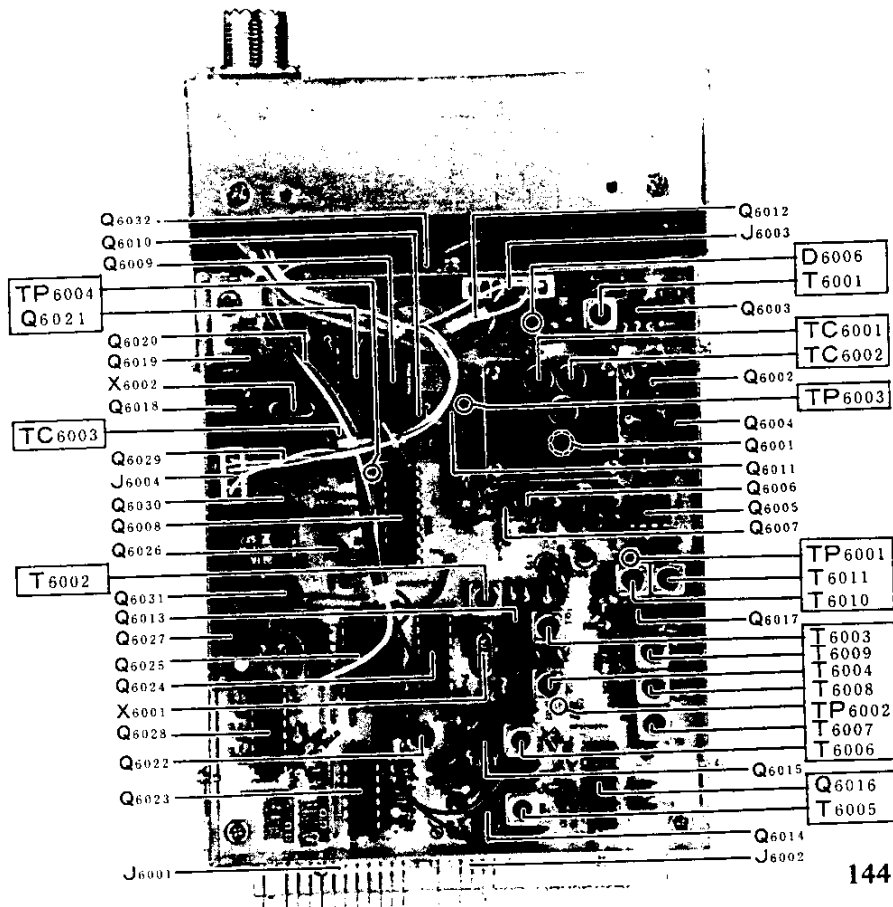

144 MHz PLL UNIT

B. Receiver Section

1. Connect the RF signal generator to the 144 MHz ANT jack, and set the output to 146.000000 MHz (or 145.000000 MHz if 146 is the band edge), with ± 3.5 kHz FM deviation and 1 kHz modulation. Tune the transceiver to the same frequency, FM mode, and set the generator output level for slight S-meter deflection. Adjust $T_{5001} - T_{5009}$ for peak on the S-meter (reduce the generator level, as required, to keep the S-meter reading below S9).
2. Connect the AF voltmeter across the speaker terminals, and set the RF generator level to -10 dB at the ANT jack. Set the AF GAIN control for an indication of -10 dBV on the AF voltmeter, and then remove the generator from the ANT jack. The AF voltmeter should now indicate less than -22 dBV (12 dB S/N).

C. Transmitter Section

1. Connect the wattmeter, dummy load and spectrum analyzer to the 144 MHz ANT jack. Preset VR_{5004} and VR_{5006} fully counterclock-

2. Tune the transceiver to 146.50 (or 145.50) MHz, FM mode. Close the PTT line and adjust $T_{5011} - T_{5015}$, TC_{5001} and TC_{5002} for maximum power output on the wattmeter.
3. Adjust VR_{5004} so that the ALC meter deflects just to the right edge of the safe ALC zone (corresponding with S9 on the S-meter scale).
4. Adjust VR_{5006} for 10W output on the wattmeter.
5. Adjust VR_{5005} so that the PO meter indicates "8" on the PO scale of Meter I.
6. Repeat steps 4 and 5 several times.
7. Adjust VR_{5003} for minimum level of the spurious signals 10.81 MHz either side of the transmitter carrier.

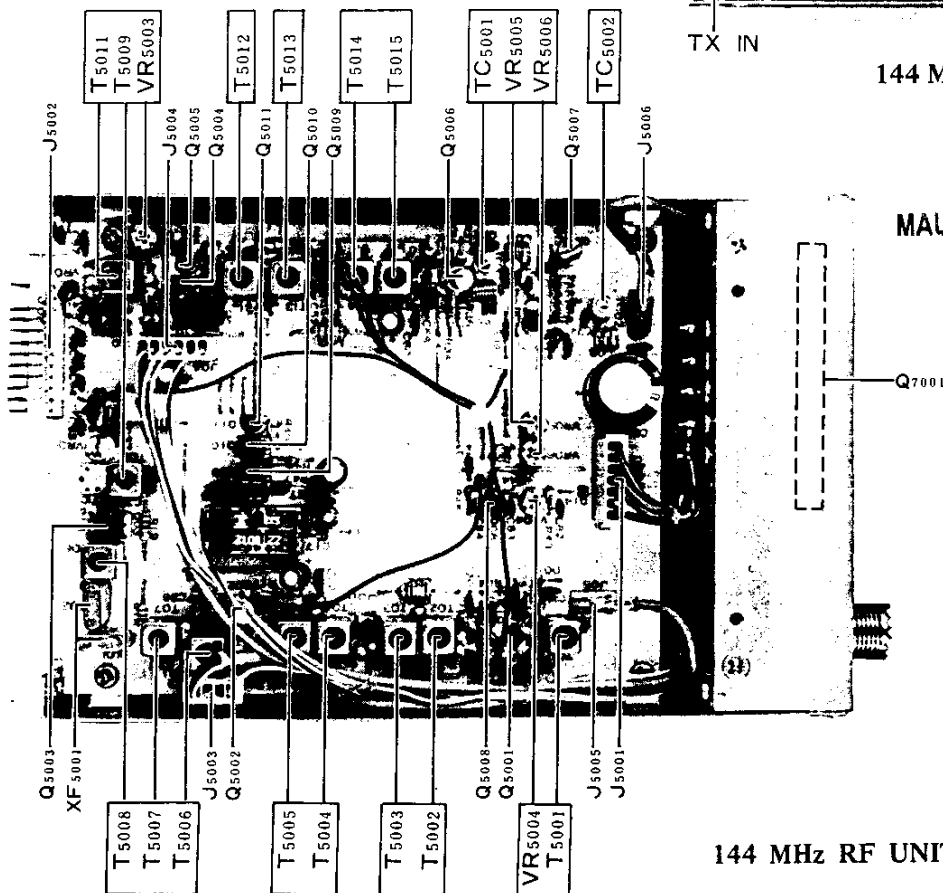
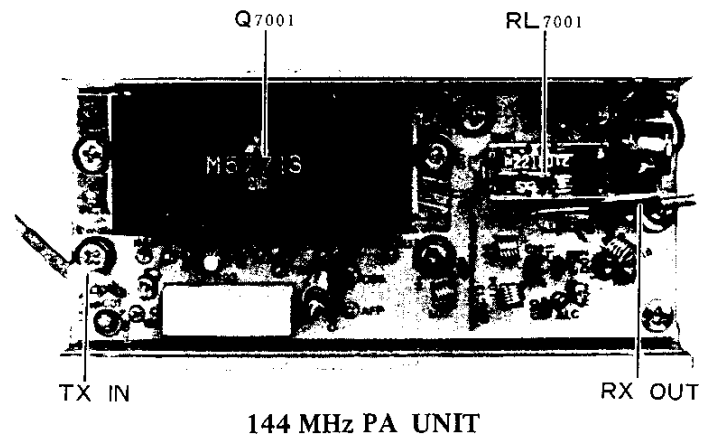

FOR SERVICE MANUALS
CONTACT:
MAURITRON TECHNICAL SERVICES
www.mauritron.co.uk
TEL: 01844 - 351694
FAX: 01844 - 352554

430 MHz AND 440 MHz MODULES

A. PLL

(If the optional SATELLITE Unit is installed, it must be switched OFF for all except step 3, which does not need to be performed if the SATELLITE Unit is not installed.)

1. Connect the frequency counter to TP₆₀₀₂, and adjust TC₆₀₀₂ for 8.533330 MHz on the counter.
2. Tune the transceiver for a display of 4xx.x50.0, and connect the RF voltmeter to TP₆₀₀₇. Adjust T₆₀₀₄ for maximum RF voltage on the meter.
3. Set the SATELLITE selector to TX, and adjust T₆₀₀₅ for maximum RF voltage on the meter. Then set the SATELLITE selector back to OFF.
4. Connect the oscilloscope to TP₆₀₀₅, and adjust T₆₀₀₂ and T₆₀₀₃ for maximum amplitude on the scope waveform (nom. 1 Vrms).
5. Connect the DC voltmeter to TP₆₀₀₆, and tune the transceiver for a display of 4xx.x99.9. Adjust TC₆₀₀₃ for 4.0V DC on the meter. Now retune for a display of 4xx.x00.0 and check for about 3.5V DC on the meter.
6. Connect the DC voltmeter to TP₆₀₀₃ and tune the transceiver for a display of 4x9.990.0. Adjust TC₆₀₀₁ for 6.5V on the meter. Retune the transceiver for display of 4x0.000.0 and check for 2.0–3.0V on the meter.
7. Connect the RF voltmeter and a 50-ohm resistive load to J₆₀₀₁, and tune the transceiver to 435 (or 445) MHz. Adjust CV₆₀₀₁ for maximum RF voltage on the meter.

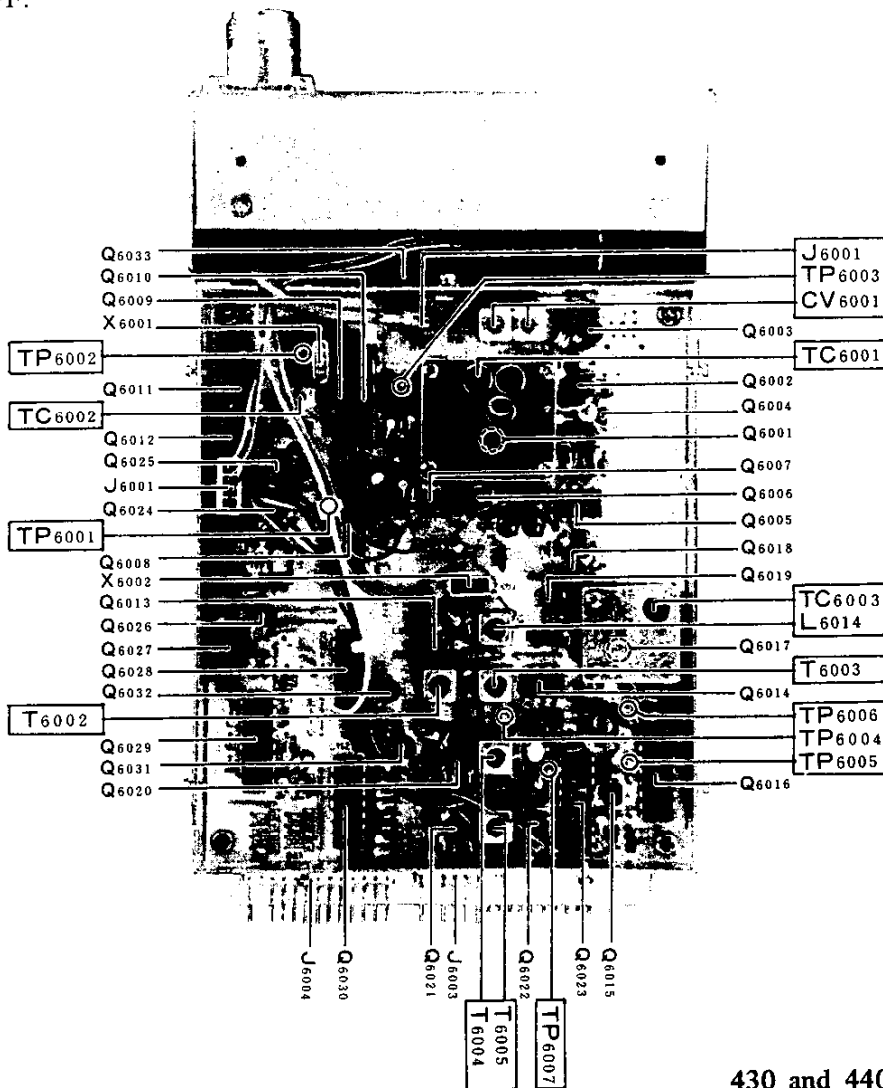

430 and 440 MHz PLL UNIT

8. Tuning the transceiver back and forth across the band, adjust CV₆₀₀₁ so that ripple in the passband is less than 2 dB.
9. Connect the frequency counter to J₆₀₀₁ and tune the transceiver for display of 435.000.0 (or 445.000.0), FM mode. Adjust L₆₀₁₄ for 367.385000 MHz (or 377.385000 MHz) on the counter.

B. Receiver Section

1. Connect the RF voltmeter to TP₅₀₀₁, close the PTT line, and adjust T₅₀₁₅ for maximum RF voltage (nom. 220 mVrms).
2. Connect the frequency counter to the anode of D₅₀₁₂, and adjust T₅₀₁₄ for 56.805000 MHz on the counter.
3. Connect the RF voltmeter to the junction of R₅₀₃₃ and C₅₀₃₉. Tune the transceiver to the center of the band and adjust CV₅₀₀₄ for maximum RF voltage on the meter. Check for less than 2 dB ripple across the band.

4. With the signal generator connected to the ANT jack, modulate the output with ± 3.5 kHz FM deviation and 1 kHz modulation, and tune the generator and transceiver to the center of the band. With the transceiver set for FM, adjust the output level of the generator for slight S-meter deflection. Adjust TC₅₀₀₁, CV₅₀₀₁, CV₅₀₀₂ and T₅₀₀₃–T₅₀₀₇ for peak S-meter deflection (adjust the generator level, if necessary, to keep the S-meter below S9).
5. Connect the SINADer across the speaker terminals and adjust T₅₀₀₃ and TC₅₀₀₁ for maximum SINAD ratio.

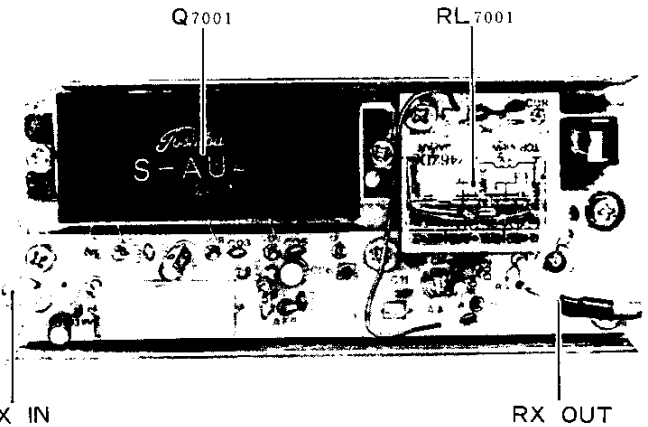

430 and 440 MHz PA UNIT

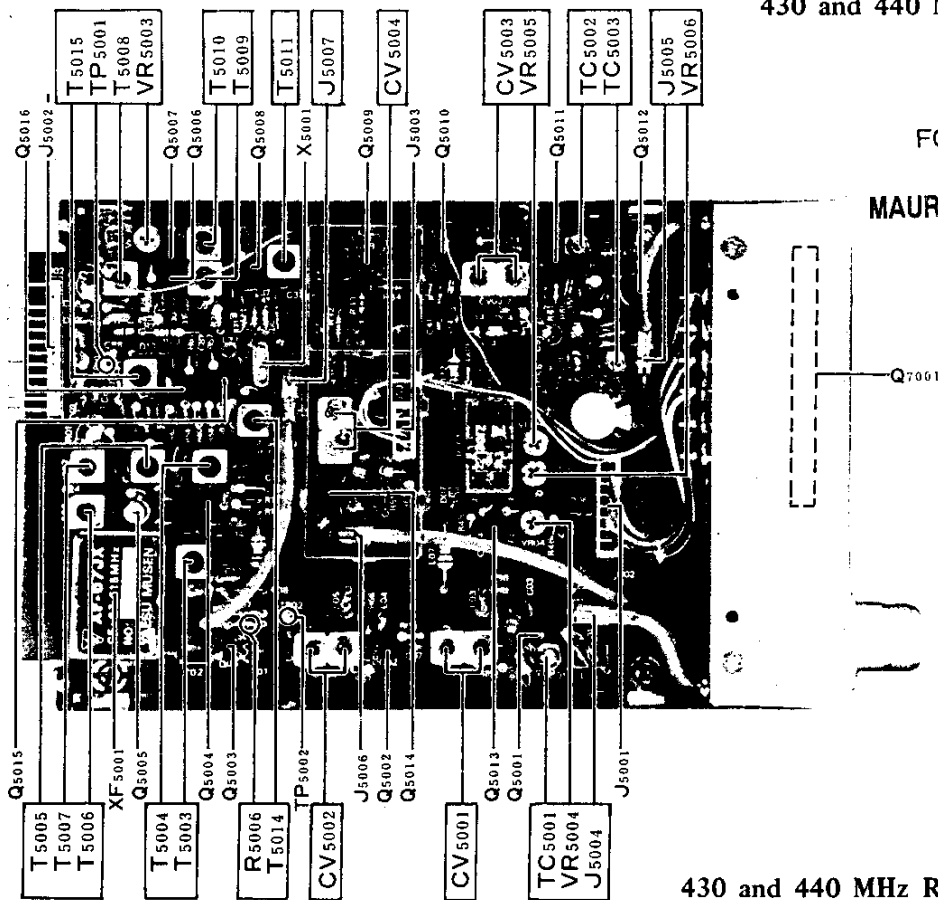

430 and 440 MHz RF UNIT

FOR SERVICE MANUALS
CONTACT:
MAURITRON TECHNICAL SERVICES
www.mauritron.co.uk
TEL: 01844 - 351694
FAX: 01844 - 352554

6. Connect the AF voltmeter across the speaker terminals and adjust the RF generator level for -15 dB to the ANT jack. Preset the AF GAIN control for -10 dBV on the AF voltmeter. Now disconnect the RF generator from the ANT jack, and check for less than -17 dBV on the AF voltmeter (7 dB S/N).

C. Transmitter Section

1. Connect the dummy load and wattmeter through a branch attenuator to the ANT jack, and connect the spectrum analyzer to the branch. Preset VR₅₀₀₄ and VR₅₀₀₆ fully counterclockwise.

2. With the transceiver tuned to the center of the band, FM mode, adjust T₅₀₀₈ - T₅₀₁₁, TC₅₀₀₂, TC₅₀₀₃ and CV₅₀₀₃ for maximum output power on the wattmeter.
3. Adjust VR₅₀₀₄ so that the ALC meter deflects just to the right edge of the safe ALC zone (corresponding with the S9 mark).
4. Adjust VR₅₀₀₆ for 10 watts output on the wattmeter.
5. Adjust VR₅₀₀₅ so that the PO meter deflects to the "8" mark on the PO scale.
6. Repeat steps 4 and 5 several times.
7. Adjust VR₅₀₀₃ for minimum level of the spurious signals 10.81 MHz on either side of the carrier frequency.

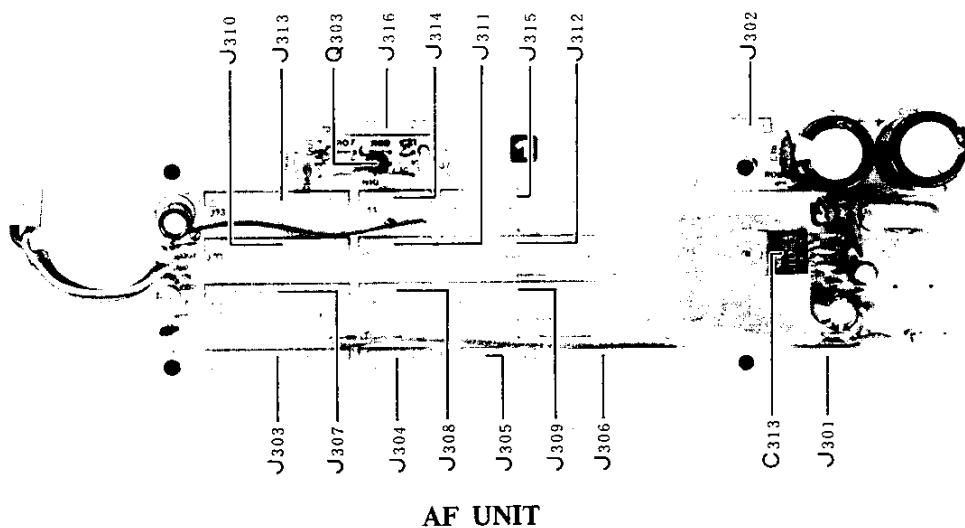

AF UNIT

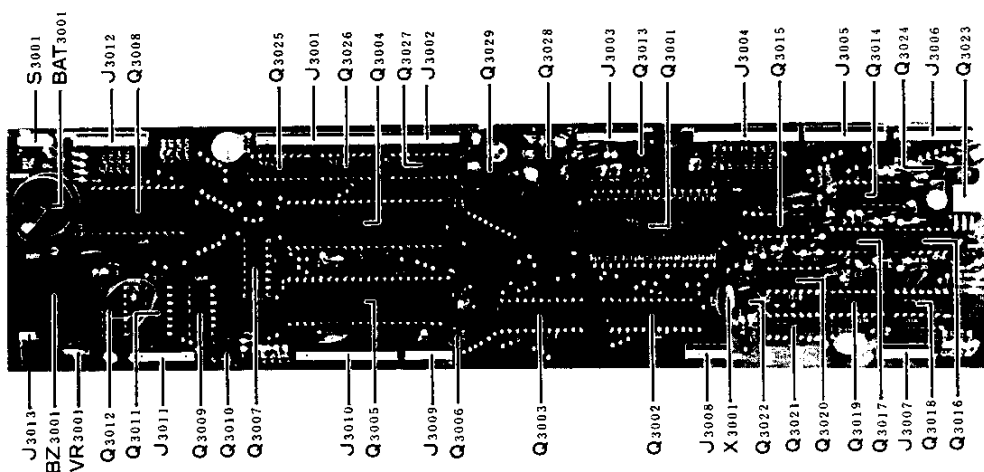

CONTROL UNIT

HF MODULE (Option)

A. PLL

(If the optional SATELLITE Unit is installed, it must be switched OFF for all except step 3, which does not need to be performed if the SATELLITE Unit is not installed.)

1. Connect the frequency counter to pin 11 of Q₆₀₀₈, and adjust T₆₀₀₅ for 58.4685 MHz (± 50 Hz) on the counter.
2. Tune the transceiver for a display of 2x.x50.0, and connect the RF voltmeter to pin 5 of Q₆₀₀₈. Adjust T₆₀₁₁ for maximum RF voltage on the meter (approx. 100 mVrms).
3. Set the SATELLITE selector to TX and adjust T₆₀₁₂ for maximum RF voltage on the meter (approx. 100 mVrms).
4. Tune the transceiver for a display of 21.4999, and connect the oscilloscope to TP₆₀₀₃. Adjust T₆₀₀₆ and T₆₀₁₁ for maximum deflection on the scope (approx. 2 Vrms).
5. Connect the frequency counter to TP₆₀₀₃ and adjust TC₆₀₀₁ for 1.4 MHz (± 10 Hz) on the counter.
6. Connect the DC voltmeter (10V range) to TP₆₀₀₁ and tune the transceiver for a display of 21.4990. Adjust T₆₀₀₄ for 6.5V on the meter. Now tune the transceiver for a display of 21.0000 and check that the meter now indicates between 3 and 4V.
7. Tune the transceiver for a display of 24.9990, and adjust T₆₀₀₃ for 6.5V on the DC voltmeter. Now tune the transceiver for a display of 24.5000 and again check for 3 to 4V on the meter.
8. Tune the transceiver for a display of 29.9990, and adjust T₆₀₀₂ for 6.5V on the DC voltmeter. Now tune the transceiver for a display of 28.0000 and again check for 3 to 4V on the meter.

FOR SERVICE MANUALS
CONTACT:
MAURITRON TECHNICAL SERVICE

www.mauritron.co.uk
TEL: 01844 - 351694
FAX: 01844 - 352554

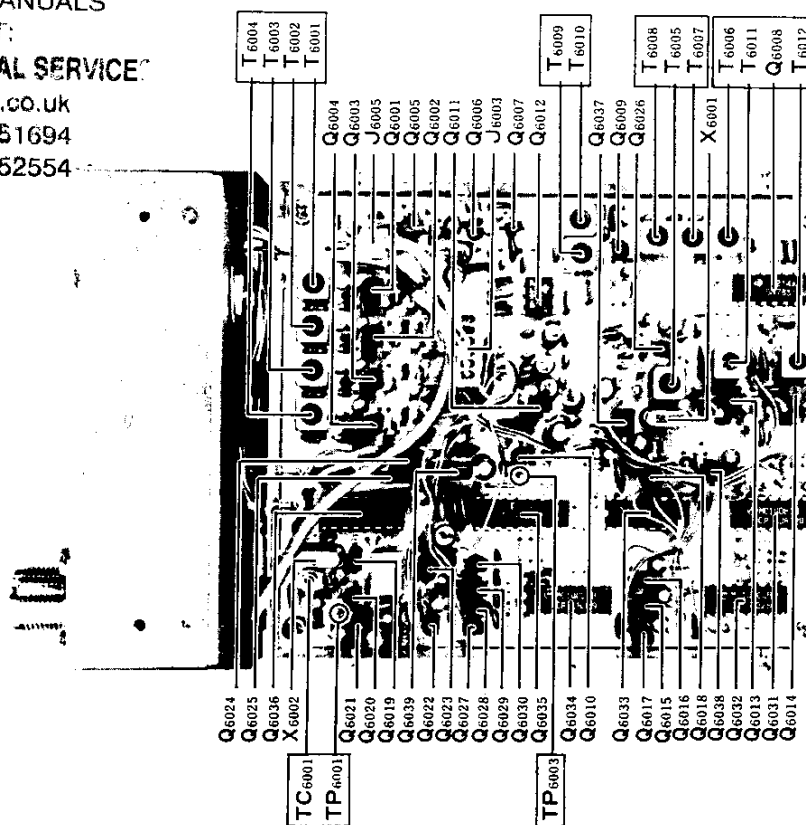

HF PLL UNIT

B. Receiver Section

1. Connect the sweep generator output to the anode of D_{5017} , and connect the detector and oscilloscope to J_{5006} . With the transceiver set to USB, adjust the transformers indicated in the table below for less than 1 dB of ripple in the three bands indicated, as shown in the diagram.

Band	Frequency	Transformer
21MHz	21.0–21.5MHz	T_{5005} , T_{5009}
24.5MHz	24.5–25.0MHz	T_{5004} , T_{5008}
28MHz	28.0–30.0MHz	T_{5002} , T_{5006}

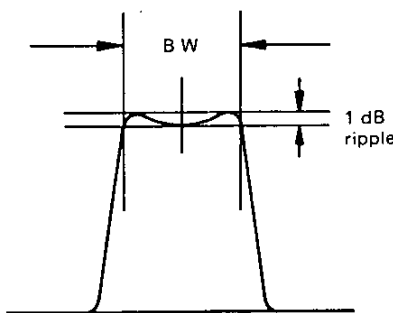

2. Connect the RF voltmeter to the cathode of D_{5002} and adjust T_{5001} for maximum RF voltage on the meter (approx. 180 mVrms).
3. Connect the frequency counter to the same point and adjust L_{5001} for 57.065 MHz (± 50 Hz) on the counter.
4. Connect the RF signal generator to the HF ANT jack, and tune it and the transceiver to 29.00 MHz. Modulate the signal generator output with 1 kHz audio at ± 3.5 kHz deviation, and set the transceiver to the FM mode. Adjust the generator output level for midscale deflection of the S-meter, and then adjust T_{5012} through T_{5017} for maximum deflection on the S-meter (reduce the generator level if necessary to retain reasonable S-meter deflection).
5. Tune the transceiver to 29.999 MHz and set the signal generator level for an S-meter indication of S9. Now tune the transceiver and generator to 28.000 MHz and note the S-meter indication. If it varies by more than 3 dB (about half an S-unit), adjust T_{5006} and then recheck both ends of the band, readjusting T_{5006} again if necessary.

6. With the same signal generator setup as in the previous two steps, tune the transceiver and generator to 29 MHz and set the signal generator output level to 20 dB. Adjust VR_{5001} for an S-meter indication of S9+30dB.
7. Connect the AF voltmeter across the speaker terminals, and set the RF generator level to -10 dBV at the ANT jack. Set the AF GAIN control for an indication of -10 dBV on the AF voltmeter, and then remove the generator from the ANT jack. The AF voltmeter should now indicate less than -22 dBV (12 dB S/N).

C. Transmitter Section

1. On the PA Unit, temporarily remove the jumper connecting the IC check terminal posts and connect the DC milliammeter between the posts. Set the milliammeter to the 300 mA range. Temporarily disconnect the center conductor of the TX IN coaxial cable. Key the transmitter and adjust VR_{7001} for an indication of 100 mA on the milliammeter. Remove the test equipment and re-connect the coaxial cable and jumper.
2. Connect the wattmeter, dummy load and spectrum analyzer to the HF ANT jack. Preset VR_{5005} and VR_{5006} fully counterclockwise, and the DRIVE control fully clockwise.
3. Tune the transceiver to 29.00 MHz, FM mode. Close the PTT line and adjust T_{5018} – T_{5021} for maximum deflection on the wattmeter (nom. 16W).
4. Adjust the DRIVE control on the front panel for 5W output, and then check the power output at 28.000 and 29.999 MHz. If it differs by more than 2W at these frequencies, adjust T_{5006} and recheck.
5. Repeat step 4 beginning at 21.25 MHz, and checking 21.000 and 21.499 MHz, adjusting T_{5009} if necessary.
6. Tune the transceiver to 29.000 MHz and set the DRIVE control to the 12 o'clock position. Close the PTT line and adjust VR_{5006} so that the ALC meter deflects to the right edge of the safe ALC zone (corresponding with S9 on the S-meter scale).
7. Set the DRIVE control fully clockwise and adjust VR_{5005} for 10W output on the wattmeter.

8. Adjust VR₅₀₀₄ so that the PO meter on the front panel indicates "8" on the PO scale of Meter I, then repeat step 6 and again step 7 several times.
9. Adjust VR₅₀₀₃ while transmitting for minimum spurious ± 10.81 MHz from the carrier frequency.

FOR SERVICE MANUALS
CONTACT:
MAURITRON TECHNICAL SERVICES
www.mauritron.co.uk
TEL: 01844 - 351694
FAX: 01844 - 352554

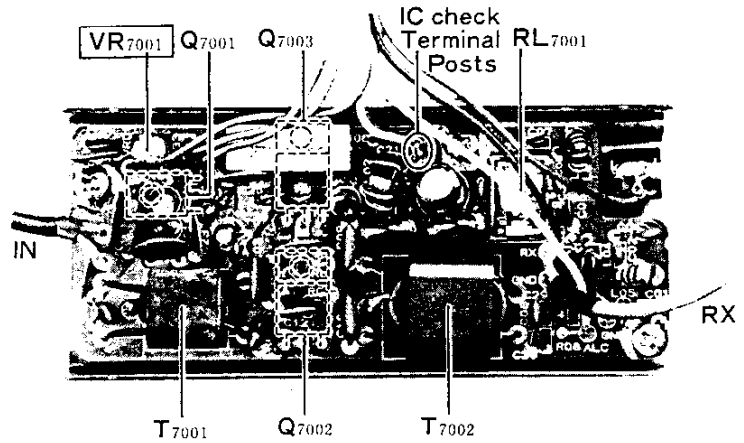

HF PA UNIT

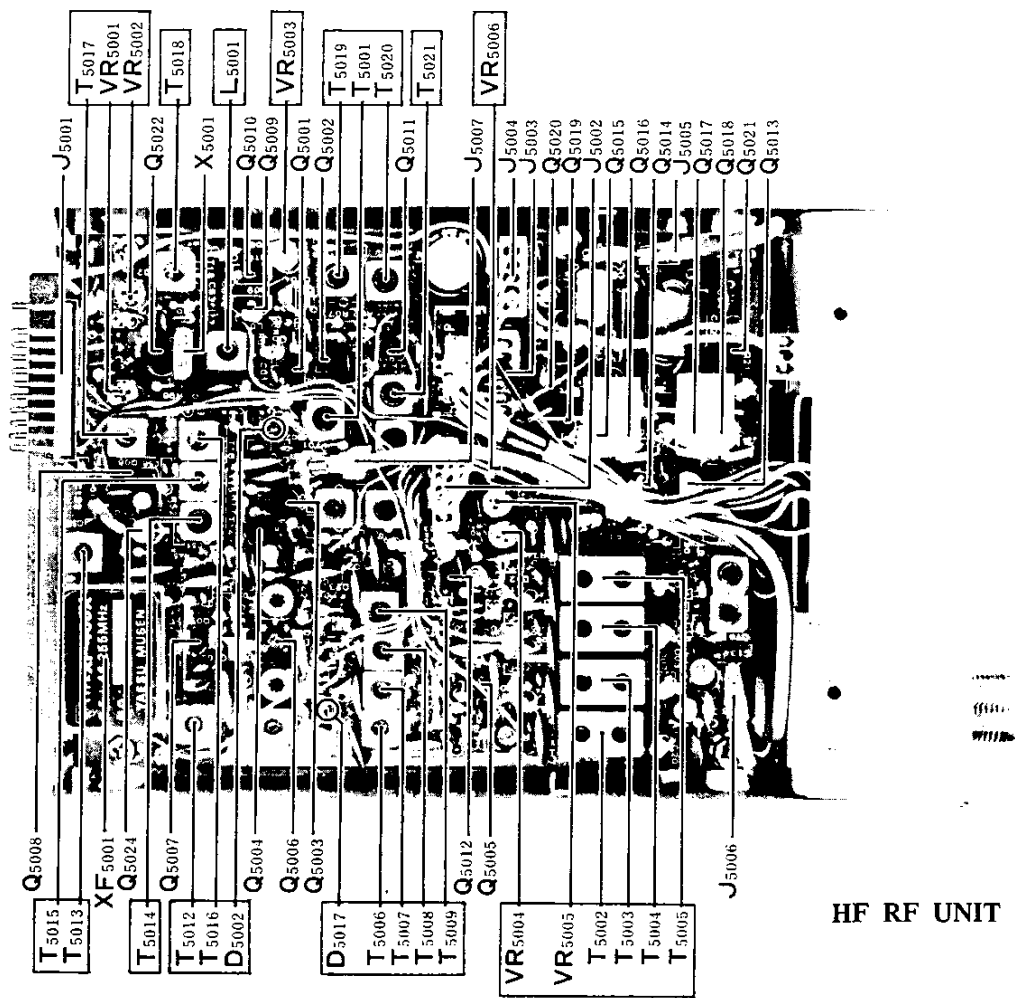

HF RF UNIT

COMPONENT APPLICATIONS

MAIN CHASSIS

PART NO.	DEVICE	TYPE	FUNCTION
Q1	μPC7808H	IC	Regulator (+8V Line)
D1	PR4632K	LED	FM-CH Indicator
D2	"	"	REV Indicator
D3	S11B	Si Diode	Reverse Voltage Protector

PART NO.	DEVICE	TYPE	FUNCTION
D201	PY4632K	LED	MODE Indicator (NOR LSB)
D202	"	"	" (NOR USB)
D203	"	"	" (NOR CW)
D204	"	"	" (NOR FM)
D205	BG4632K	"	" (SAT LSB)
D206	"	"	" (SAT USB)
D207	"	"	" (SAT CW)
D208	"	"	" (SAT FM)
D209	TLR205	"	ON AIR Indicator
D210	TLG205	"	BUSY (MOD) Indicator

VFO UNIT

PART NO.	DEVICE	TYPE	FUNCTION
Q101	2SK192A-GR	JFET	PLL VCO (for NOR VFO)
Q102	2SK241Y	"	PLL Buffer Amplifier
Q103	2SC535B	Transistor	PLL Output Buffer
Q104	HD10551P	IC	1/44 Divider
Q105	μPC1037H	"	NOR VFO Premixer
Q106	2SK241Y	JFET	PLL Buffer Amplifier
Q107	μPC1037H	IC	PLL Mixer
Q108	2SC535B	Transistor	PLL IF Amplifier
Q109	2SC460B	"	PLL Local Oscillator (NOR VFO)
Q110	2SC535B	"	PLL Local Oscillator Multiplier (x9)
Q111	MC14094B	IC	Latch (NOR VFO PLL Divider Data)
Q112	"	"	" (")
Q113	TC9122P	"	PLL Programmable Divider
Q114	TC5082P	"	PLL Reference Oscillator, 1/1024 Divider
Q115	TC5081AP	"	PLL Phase Detector
Q116	2SK30AY	JFET	PLL Loop Filter Buffer
Q117	2SC945AP	Transistor	PLL Loop Filter
Q118	"	"	Switch (NOR VFO PLL Data)
Q119	"	"	Inverter (")
Q120	2SA733Q	"	PLL Unlock Signal Amplifier
Q121	2SC945AP	"	PLL Unlock Switch
D101	1T25	Varactor Diode	PLL VCO (for NOR VFO)
D102	1SS53	Si Diode	PLL Oscillator Frequency Control Switch
D103	"	"	"
D104	"	"	"
X101	6.38MHz	Crystal (HC-18/U)	PLL Local Oscillator (NOR VFO)
X102	4.5056MHz	" (")	PLL Reference Oscillator
TH101	33D28	Thermistor	Temperature Compensator (for Q101)

DISPLAY UNIT

PART NO.	DEVICE	TYPE	FUNCTION
V201	FIP-12A5A	FCD	Frequency Display

AF UNIT

PART NO.	DEVICE	TYPE	FUNCTION
Q301	Not Used		
Q302	μPC2002H	IC	RX Audio Amplifier
Q303	2SC945AP	Transistor	TX Driver
D301	1SV80	PIN Diode	TX Power Controller

SCAN/SQL SWITCH UNIT

PART NO.	DEVICE	TYPE	FUNCTION
Q501	2SA733AP	Transistor	TONE SQL Switch (FM)
Q502	2SC945AP	"	RX TONE Amplifier
D501	1SS53	Si Diode	TONE SQL Switch (FM)

TX UNIT

PART NO.	DEVICE	TYPE	FUNCTION
Q1001	2SC1815GR	Transistor	TX MIC Amplifier
Q1002	"	"	" (FM)
Q1003	μPC1158H2	IC	" (SSB)
Q1004	2SC945AP	Transistor	TX Audio ALC Amplifier (SSB Audio Speech Processor)
Q1005	"	"	TX AF Amplifier (for FM)
Q1006	"	"	TX Active LPF (")
Q1007	"	"	TX AF Amplifier (")
Q1008	2SC460B	"	TX FM Carrier Mod. VCXO
Q1009	Not Used		
Q1010	"		
Q1011	2SC460B	Transistor	TX CW Carrier Oscillator
Q1012	3SK73Y	MOS FET	TX 1st IF Buffer Amplifier (FM, CW)
Q1013	2SC945AP	Transistor	TX AF Buffer Amplifier (SSB)
Q1014	μPC1037H	IC	TX Balanced Modulator (")
Q1015	2SA733AQ	Transistor	Carrier Oscillator Sideband Selector (USB)
Q1016	"	"	" (LSB)
Q1017	2SC460B	"	Carrier Oscillator
Q1018	3SK73Y	MOS FET	TX 1st IF Amplifier
Q1019	2SA733AQ	Transistor	FM TX 8V Switch
Q1020	Not Used		

Q1021	2SA733AQ	Transistor	CW TX 8V Switch	D1038	1SS53	Si Diode	TX CW Controller
Q1022	"	"	SSB TX 8V Switch	D1039	"	"	Threshold Level
Q1023	2SC1815BL	"	TX ALC Amplifier				Compensator (for Q1033)
Q1024	2SK192A-GR	JFET	TX ALC Meter Amplifier	D1040	"	"	TX CW Controller
Q1025	2SA733AQ	Transistor	"	D1041	"	"	"
Q1026	Not Used			D1042	"	"	"
Q1027	2SC945AP	Transistor	TX MOD Indic. Signal Amplifier	D1043	"	"	Gate Protector (for Q1035)
				D1044	"	"	"
Q1028	"	"	MOD LED Driver	D1045	"	"	Threshold Level
Q1029	"	"	TX Sidetone Switch				Compensator (for Q1037)
Q1030	"	"	TX MOD Indic. Switch	D1046	"	"	Reverse Voltage Protector
Q1031	MC14011B	IC	TX CW Sequencer				(for Q1038)
Q1032	MC14069UB	"	"	D1047	"	"	" (for RL1001)
Q1033	2SC945AP	Transistor	TX CW KEY Switch	D1048	"	"	" (for Q1039)
Q1034	"	"	TX CW Delayer	D1049	"	"	" (for RL1002)
Q1035	MC14081B	IC	TX VFO Select Gates	D1050	"	"	TX Tone Burst Switch
Q1036	μPC78L05	"	Regulator (+5V Line)	D1051	Not Used		
Q1037	2SC945AP	Transistor	PTT Switch	D1052	"		
Q1038	MPS-A13	"	Relay Driver (for RL1001)	D1053	"		
Q1039	2SC945AP	"	" (for RL1002)	D1054	"		
Q1040	2SA496Y	"	SAT TX Switch	D1055	1SS53	Si Diode	TX MOD Indic. Switch
				D1056	"	"	TX MOD Indic. Disable
D1001	1S188FM	Ge Diode	TX Audio ALC Detector (SSB Audio Speech Processor)	D1057	"	"	Switch (CW)
				D1058	MV12	Varistor	MODE Switch (for CW)
D1002	"	"	" (")			Diode	Temperature Compensator (for Q1033)
D1003	1S1555	Si Diode	TX FM IDC				
D1004	"	"	"	X1001	10.81MHz	Crystal	TX FM Carrier Mod VCXO
D1005	FC53M-5	Varactor Diode	TX FM Modulator				(HC-18/T3P)
				X1002	10.8092MHz	" (HC-18/U)	TX CW Carrier Oscillator
D1006	MV103	Varistor Diode	Temperature Compensator [for TX FM Modulator (D1005)]	X1003	10.8115MHz	" (")	USB Carrier Oscillator
				X1004	10.8085MHz	" (")	LSB
D1007	1SS53	Si Diode	MODE Switch (FM)	XF1001	XF-10.8LS	Crystal Filter	TX SSB Filter
D1008	WZ050	Zener Diode	Regulator (for TX FM Modulator VCXO)				
D1009	1SS53	Si Diode	MODE Switch (for FM)	TH1001	SDT250	Thermistor	Temperature Compensator (for Q1023)
D1010	Not Used						
D1011	"						
D1012	"						
D1013	"						
D1014	"						
D1015	"						
D1016	1SS53	Si Diode	MODE Switch (CW)				
D1017	"	"	KEY Switch				
D1018	1S1588	"	TX 1st IF Limiter (FM, CW)	Q2001	3SK73Y	MOS FET	RX 1st IF Amplifier (for 50MHz, 144 MHz), RX
D1019	"	"	" (")				2nd IF Amplifier (for
D1020	1SS53	"	MODE Switch (")				430MHz)
D1021	"	"	" (SSB)	Q2002	2SK125	JFET	RX 2nd Mixer (for 50MHz,
D1022	"	"	Carrier Oscillator LSB Selector				144MHz), RX 3rd Mixer
							(for 430MHz)
D1023	"	"	" USB Selector	Q2003	2SC460B	Transistor	RX IF SHIFT VCXO
D1024	"	"	SSB BFO Switch (RX)	Q2004	2SC535B	"	RX IF SHIFT VCXO Buffer
D1025	"	"	" (TX)				Amplifier
D1026	"	"	SAT TX Switch	Q2005	"	"	RX 2nd IF Buffer Amplifier
D1027	"	"	MODE Switch (FM)				(for 50MHz, 144MHz, FM),
D1028	Not Used						RX 3rd IF Buffer Amplifier
D1029	1SS53	Si Diode	MODE Switch (CW)				(for 430MHz FM)
D1030	"	"	" (SSB)	Q2006	2SC945AP	"	" (")
D1031	"	"	" (CW)				" (")
D1032	"	"	" (LSB)				" (")
D1033	"	"	" (USB)	Q2007	μPC577H	IC	RX FM Limiter Amplifier
D1034	Not Used			Q2008	2SC1815GR	Transistor	RX FM AF Amplifier
D1035	"			Q2009	3SK73Y	MOS FET	RX 2nd IF Amplifier (for
D1036	1SS53	Si Diode	TX MOD Indic. Signal Detector				50MHz, 144MHz SSB, CW)
D1037	"	"	"				RX 3rd IF Amplifier (for
							430MHz SSB, CW)

RX UNIT

PART NO. DEVICE TYPE FUNCTION

Q2010	μPC1037H	IC	RX IF WIDTH Mixer (SSB, CW)	D2016	Not Used		
Q2011	"	"	" (")	D2017	"		
Q2012	3SK73Y	MOS FET	RX 2nd IF Amplifier (for 50MHz, 144MHz, SSB, CW)	D2018	1SV50	Varactor Diode	RX IF WIDTH VCXO
			RX 3rd IF Amplifier (for 430MHz SSB, CW)	D2019	Not Used		
Q2013	μPC1037H	IC	RX Balanced Demodulator (SSB, CW)	D2020	"		
Q2014	"	"	RX BFO Premixer	D2021	"		
Q2015	2SC460B	Transistor	RX IF WIDTH VCXO	D2022	"		
Q2016	2SC945AP	"	RX AGC Buffer Amplifier	D2023	1S188FM	Ge Diode	RX AGC Detector
Q2017	Not Used			D2024	"	"	"
Q2018	2SC1815GR	Transistor	RX AF Amplifier	D2025	1SS53	Si Diode	"
Q2019	2SC945AP	"	RX AF Active LPF	D2026	1S188FM	Ge Diode	RX FM S-Meter Detector
Q2020	2SC535B	"	RX NB Buffer Amplifier	D2027	"	"	"
Q2021	2SC1583	"	RX NB Amplifier	D2028	1S1555	Si Diode	Threshold Level Compensa- tor [for RX FM Noise Detector (D2029, 2030)]
Q2022	"	"	"	D2029	1S188FM	Ge Diode	RX FM Noise Detector
Q2023	"	"	"	D2030	"	"	"
Q2024	2SC945AP	"	RX NB AGC Amplifier	D2031	"	"	RX AGC Detector
Q2025	2SC1815GR	"	RX NB Gate Controller	D2032	"	"	"
Q2026	2SC945AP	"	RX FM S-Meter Amplifier	D2033	1SS53	Si Diode	RX RF GAIN AGC Gate
Q2027	"	"	RX FM Noise Amplifier	D2034	"	"	AGC Threshold Level Compensator (for Q1035)
Q2028	"	"	"	D2035	"	"	RX SQL Switch (SSB, CW)
Q2029	2SC1815GR	"	RX FM SQL Switch	D2036	Not Used		
Q2030	"	"	RX SCAN Switch (FM)	D2037	"		
Q2031	"	"	" (SSB, CW)	D2038	1SS53	Si Diode	SSB RX 8V Gate
Q2032	2SC945AP	"	RX BUSY Indicator Switch	D2039	"	"	CW "
Q2033	2SC1815BL	"	RX AGC DC Amplifier	D2040	"	"	RX Filter Select Switch (CW)
Q2034	AN6561	IC	RX AGC Buffer Amplifier	D2041	Not Used		
Q2035	2SA733	Transistor	RX S-Meter Amplifier (SSB, CW)	D2042	"		
Q2036	2SC945AP	"	RX SQL Switch (")	D2043	1SS53	Si Diode	Reverse Voltage Protector (for Q2046)
Q2037	"	"	" (")	D2044	"	"	RX AF Amplifier (Q2018) Disable Switch (NOR TX)
Q2038	2SA733	"	FM RX 8V Switch	D2045	"	"	RX AGC Buffer Amplifier Limiter
Q2039	AN6561	IC	RX FM Center Tune Buffer Amplifier (dual)	D2046	"	"	Threshold Level Compensator (for Q2034)
Q2040	2SC945AP	Transistor	RX SCAN Controller (FM)	D2047	"	"	RX AF Amplifier (Q2048) Disable Switch (NOR TX)
Q2041	2SA733	"	" (")	D2048	"	"	RX SCAN Controller (FM)
Q2042	"	"	" (")				
Q2043	"	"	RX FM Center Meter Amplifier				
Q2044	"	"	SSB CW RX 8V Switch	X2001	11.265MHz	Crystal (HC-18/U3P)	RX IF SHIFT VCXO
Q2045	Not Used			X2002	11.205MHz	" (")	RX IF WIDTH VCXO
Q2046	2SC945AP	Transistor	Relay Driver (for RL2001)				
Q2047	"	"	RX AF Disable Switch (on NOR TX)	XF2001	108M15A	Crystal Filter	RX 1st IF Filter (for 50MHz, 144MHz)
Q2048	"	"	RX AF Buffer Amplifier (for AF OUT)				RX 2nd IF Filter (for 430MHz)
D2001	FC53M-5	Varactor Diode	RX IF SHIFT VCXO	XF2002	XF-10.7LW	"	RX IF WIDTH Filter
D2002	1SS53	Si Diode	MODE Switch (FM)	XF2003	XF-455MC	"	Optional RX 2nd IF Filter (for 50MHz, 144MHz CW-N)
D2003	"	"	" (")				
D2004	1S188FM	Ge Diode	RX FM Discriminator				
D2005	"	"	"				
D2006	Not Used						
D2007	"			CF2001	LF-H15S	Ceramic Filter	RX FM IF Filter
D2008	"			CF2002	Not Used		
D2009	1SS53	Si Diode	RX Filter Select Switch (SSB, CW-W)	CF2003	LF-C2A	Ceramic Filter	RX 2nd IF Filter (for 50MHz, 144MHz SSB, CW)
D2010	"	"	" (")				
D2011	"	"	" (SSB)				
D2012	"	"	" (CW-N)				
D2013	"	"	" (")				
D2014	Not Used			CF2004	LF-B20	"	RX FM IF Filter
D2015	"						

CD2001	SFD455S4	Ceramic Filter	RX FM Discriminator
TH2001	SDT-250	Thermistor	Temperature Compensator (for Q2029)

CONTROL UNIT

PART NO.	DEVICE	TYPE	FUNCTION
Q3001	μPD7801G-090	IC	CPU
Q3002	μPD5101LC	"	RAM
Q3003	"	"	"
Q3004	μPD8279C-5	"	Frequency Display Controller
Q3005	μPD8255AC-5	"	PIO (for PLL Divider, MODE, REV, FM-CH Data)
Q3006	2SD8920	Transistor	REV Indicator Driver
Q3007	MC14503B	IC	PLL Data Buffer
Q3008	MC14515B	"	Frequency Display Decoder
Q3009	MC14069UB	"	MODE Data Decoder
Q3010	2SC945AP	Transistor	"
Q3011	SN7416N	IC	"
Q3012	MC14001B	"	Beep Oscillator
Q3013	2SC945AP	Transistor	SCAN Stop Switch (PTT)
Q3014	MC14011B	IC	SCAN Controller
Q3015	MC14069UB	"	CPU Reset Switch (Power Up)
Q3016	"	"	VFO Controller
Q3017	"	"	"
Q3018	MC14081B	"	"
Q3019	MC14072B	"	"
Q3020	MC14011B	"	FM-CH Controller
Q3021	MC14013B	"	UP/DOWN Controller
Q3022	2SC945AP	Transistor	FM-CH Indicator Driver
Q3023	μPC7805H	IC	Regulator (+5V Line)
Q3024	2SC945AP	Transistor	CPU Reset Switch
Q3025	μPA80C	IC	FCD Driver
Q3026	"	"	"
Q3027	"	"	"
Q3028	2SC1383R	Transistor	Regulator (+11V for DC-DC Converter)
Q3029	2SC2002L	"	DC-DC Converter Oscillator
D3001	1SS53	Si Diode	Decoder (for Memory Channel Data)
D3002	"	"	" (")
D3003	"	"	" (")
D3004	"	"	" (")
D3005	"	"	TONE SQL Decoder
D3006	"	"	Mem Ch Decoder
D3007	"	"	FM-CH Decoder
D3008	"	"	DIAL LOCK Decoder
D3009	"	"	VFO Select Decoder
D3010	"	"	"
D3011	HZ9C1	Zener Diode	Threshold Level Compensator (for Q3024)
D3012	1SS97	Schottky Barrier Di.	RAM Backup Switch
D3013	"	"	Backup Battery Protector
D3014	1SS53	Si Diode	FM-CH Decoder
D3015	"	"	"
D3016	"	"	UP/DOWN Decoder
D3017	"	"	"
D3018	Not Used		
D3019	1SS53	Si Diode	SSB Decoder

D3020	1SS53	Si Diode	SSB Decoder
D3021	"	"	Beep Oscillator Control
D3022	"	"	Decoder (for Display Data)
D3023	"	"	" (")
D3024	"	"	" (")
D3025	"	"	" (")
D3026	"	"	" (")
D3027	"	"	" (")
D3028	"	"	" (")
D3029	"	"	" (")
D3030	HZ11B1	Zener Diode	Regulator
D3031	1SS53	Si Diode	Rectifier
D3032	HZ3B2	Zener Diode	Clipper (for DC-DC Converter)
D3033	1SS53	Si Diode	CLAR/FM-CH Decoder
D3034	"	"	"
X3001	CSA4.00MT	Ceramic Resonator	CPU Clock

PS UNIT

PART NO.	DEVICE	TYPE	FUNCTION
Q601	2SD7170	Transistor	Pass Tran for +13.8V Reg.
D601	S5VB10	Si Diode Bridge	Rectifier

AVR UNIT

PART NO.	DEVICE	TYPE	FUNCTION
Q701	2SC496Y	Transistor	Regulator
Q702	2SC945AP	"	"
D701	10D1	Si Diode	Rectifier
D702	HZ6B2	Zener Diode	Regulator Reference

SATELLITE UNIT

PART NO.	DEVICE	TYPE	FUNCTION
Q4001	2SA733AQ	Transistor	TX Carrier Oscillator Sideband Selector (USB)
Q4002	"	"	" (LSB)
Q4003	2SC460B	"	TX Carrier Oscillator
Q4004	Not Used		
Q4005	"		
Q4006	2SC945AP	Transistor	TX Amplifier (SSB)
Q4007	μPC1037H	IC	TX Balanced Modulator (")
Q4008	2SC945AP	Transistor	TX AF Amplifier (FM)
Q4009	2SC460B	"	TX FM Carrier Mod. VCXO
Q4010	"	"	TX CW Carrier Oscillator
Q4011	3SK73Y	MOS FET	TX 1st IF Buffer Amplifier (FM, CW)
Q4012	2SA733AQ	Transistor	MODE Switch (FM)
Q4013	Not Used		
Q4014	2SA733AQ	Transistor	MODE Switch (CW)
Q4015	"	"	" (SSB)
Q4016	2SK192A-GR	JFET	PLL VCO (for SAT VFO)
Q4017	2SK241Y	"	PLL Buffer Amplifier
Q4018	2SC535B	Transistor	PLL Output Buffer

Q4019	HD10551	IC	1/44 Divider (PLL Out)	D4031	1T25	Varactor Diode	PLL VCO (SAT VFO)
Q4020	μPC1037H	"	SAT VFO Premixer	D4032	1SS53	Si Diode	PLL Local Oscillator Frequency Select Switch
Q4021	2SK241Y	JFET	PLL Buffer Amplifier	D4033	"	"	"
Q4022	μPC1037H	IC	PLL Mixer	D4034	"	"	"
Q4023	2SC535B	Transistor	PLL IF Amplifier	X4001	10.7015MHz	Crystal (HC-18/U)	TX Carrier Oscillator (LSB)
Q4024	2SC460B	"	PLL Local Oscillator (SAT VFO)	X4002	10.6985MHz	" (")	" (USB)
Q4025	2SC535B	"	PLL Local Oscillator Multiplier (x9)	X4003	10.7MHz	" (HC-18/T3P)	TX FM Carrier Mod VCXO
Q4026	MC14094BCP	IC	Latch (SAT VFO PLL Divider Data)	X4004	10.6992MHz	" (HC-18/U)	TX CW Carrier Oscillator
Q4027	"	"	" (")	X4005	6.4713MHz	" (")	PLL Local Oscillator (for SAT VFO)
Q4028	TC9122P	"	PLL Programmable Divider	X4006	4.5056MHz	" (")	PLL Reference Oscillator
Q4029	TC5082P	"	PLL Reference Oscillator, 1/1024 Divider	XF4001	XF-10.7LS	Crystal Filter	SAT TX SSB Filter
Q4030	TC5081AP	"	PLL Phase Detector	TH4001	33D28	Thermistor	Temperature Compensator (for Q4016)
Q4031	2SK30AY	JFET	PLL Loop Filter Inverter				
Q4032	2SC945AP	Transistor	PLL Loop Filter				
Q4033	"	"	Switch (SAT VFO PLL Data)				
Q4034	2SA733AQ	"	PLL Unlock Signal Amplifier				
Q4035	2SC945AP	"	PLL Unlock Switch				
Q4036	"	"	Inverter (SAT VFO PLL Data)				
Q4037	μPC78L05	IC	Regulator (+5V Line)				
Q4038	SN7416N	"	Inverter (MODE Data)				
Q4039	2SC945AP	Transistor	TX 1st IF Buffer Amplifier (SSB)				
D4001	1SS53	Si Diode	TX Carrier Oscillator Sideband Select Decoder (USB)				
D4002	"	"	" (LSB)				
D4003	"	"	" (USB)				
D4004	"	"	" (LSB)				
D4005	Not Used						
D4006	FC53M-5	Varactor Diode	TX FM Modulator				
D4007	MV103	Varistor Diode	Temperature Compensator [for TX FM Modulator (D4006)]				
D4008	WZ050	Zener Diode	Regulator (for TX FM Carrier Mod Oscillator)				
D4009	Not Used						
D4010	"						
D4011	"						
D4012	"						
D4013	"						
D4014	1SS53	Si Diode	MODE Switch (SAT CW)				
D4015	"	"	" (")				
D4016	"	"	" (SAT FM)				
D4017	"	"	KEY Switch				
D4018	1S1588	"	TX 1st IF Limiter (SAT FM, SAT CW)				
D4019	"	"	" (")				
D4020	1SS53	"	MODE Switch (")				
D4021	"	"	" (SAT SSB)				
D4022	"	"	" (SAT FM)				
D4023	Not Used						
D4024	1SS53	Si Diode	MODE Switch (for SAT CW)				
D4025	"	"	" (SAT LSB)				
D4026	"	"	" (SAT USB)				
D4027	"	"	" (SAT FM)				
D4028	Not Used						
D4029	"						
D4030	"						

50 MHz MODULE: RF UNIT

PART NO.	DEVICE	TYPE	FUNCTION
Q5001	3SK74L	MOS FET	RX RF Amplifier
Q5002	3SK51-03	"	RX 1st Mixer
Q5003	2SK125	JFET	RX 1st IF Amplifier
Q5004	2SK241Y	"	TX 2nd Mixer
Q5005	"	"	"
Q5006	3SK73Y	MOS FET	TX RF Buffer Amplifier
Q5007	2SC460B	Transistor	TX RF Predriver
Q5008	2SC2053	"	TX RF Driver
Q5009	2SA733AQ	"	TX AFP Amplifier
Q5010	2SD471L	"	Regulator (TX 9V)
Q5011	"	"	" (")
Q5012	2SK125	JFET	" (")
D5001	MV13	Varistor Diode	Temperature Compensator (for Q5001)
D5002	1T25	Varactor Diode	RX Auto-Tune Circuit
D5005	1T25	Varactor Diode	RX Auto-Tune Circuit
D5006	1SV50	"	"
D5007	1SS53	Si Diode	T/R Switch (RX Out)
D5008	"	"	" (TX In)
D5009	1T25	Varactor Diode	TX Auto-Tune Circuit
D5013	1T25	Varactor Diode	TX Auto-Tune Circuit
D5014	1SS53	Si Diode	Temperature Compensator (for Q5006)
D5015	1S1554	"	" (for Q5008)
D5016	Not Used		
D5017	1SS97	Schottky Barrier Di.	Switch (for PO Meter)
D5018	1SS53	Si Diode	AFP → ALC
D5019	"	"	Regulator (TX 9V)
D5020	WZ090	Zener Diode	" (")
D5021	V06B	Si Diode	Reverse Voltage Protector (for RL5001)

D5022	1T25	Varactor Diode	TX Auto-Tune Circuit	D6007	1SS53	Si Diode	VFO Selector (SAT VFO)
D5023	1SS97	Schottky Barrier Di.	Switch (ALC)	D6008	"	"	" (NOR VFO)
				D6009	"	"	" (SAT VFO)
				D6010	"	"	" (NOR VFO)
XF5001	10.8M30B	Crystal Filter	RX 1st IF Filter	D6011	V06B	"	Reverse Voltage Protector (for Q6022)
				D6012	1SS53	"	NOR TX STBY Decoder
TH5001	31D26	Thermistor	Temperature Compensator (RX Output Level)	D6013	"	"	SAT TX STBY Decoder
				D6014	"	"	NOR Strobe Decoder
TH5002	25D29	"	" (TX Input Level)	D6015	"	"	SAT Strobe Decoder
				D6016	V06B	"	Reverse Voltage Protector (for Q6031)

50 MHz MODULE: PLL, VCO UNITS

PART NO.	DEVICE	TYPE	FUNCTION
Q6001	2SK192A-GR	JFET	PLL VCO (RX 1st, TX 2nd Local Oscillator)
Q6002	2SK241Y	"	VCO Buffer Amplifier
Q6003	3SK73Y	MOS FET	PLL Output Buffer Amplifier (RX 1st, TX 2nd Local)
Q6004	2SK241Y	JFET	PLL Buffer Amplifier
Q6005	SN16913P	IC	PLL Mixer
Q6006	2SC945AP	Transistor	PLL IF Buffer Amplifier
Q6007	"	"	"
Q6008	TC9122P	IC	PLL Programmable Divider
Q6009	TC5081AP	"	PLL Phase Detector
Q6010	2SC945AP	Transistor	PLL Active LPF
Q6011	"	"	"
Q6012	"	"	PLL VCO (Q6001) Band Switch
Q6013	2SC460B	"	PLL Local Oscillator
Q6014	2SC945AP	"	SAT VFO Buffer Amplifier
Q6015	"	"	NOR VFO Buffer Amplifier
Q6016	SN76514N	IC	PLL Local Premixer
Q6017	2SC535B	Transistor	PLL Local Buffer
Q6018	2SC945AP	"	PLL Unlock Switch
Q6019	2SA564A	"	PLL Unlock Signal Amplifier
Q6020	2SC945AP	"	PLL Reference Oscillator
Q6021	MB84024B	IC	PLL Reference 1/64 Divider
Q6022	2SD892Q	Transistor	STBY Switch
Q6023	MC14081B	IC	NOR/SAT TX Select Data and STROBE Decoder
Q6024	MC14560B	"	VCO Band Decoder
Q6025	MC14094B	"	Latch (PLL Divider Data)
Q6026	2SC945AP	Transistor	Switch (")
Q6027	μPC78L05	IC	Regulator (+5V Line)
Q6028	MC14504B	"	PLL Divider Data Decoder
Q6029	2SC945AP	Transistor	VFO Selector (SAT VFO)
Q6030	"	"	" (NOR VFO)
Q6031	2SD892Q	"	Relay Driver (for RL6001)
Q6032	μPC7808H	IC	Regulator (+8V Line)
D6001	1SV50	Varactor Diode	PLL VCO Control
D6002	"	"	"
D6003	1SS53	Si Diode	PLL VCO (Q6001) Band Switch
D6004	1SV50	Varactor Diode	PLL Auto-Tune Circuit
D6005	1SS53	Si Diode	T/R Switch (RX Local)
D6006	"	"	" (TX Local)

D6017	1SS53	"	PLL NOR Data Decoder
D6018	"	"	PLL SAT TX Decoder
D6019	"	"	PLL SAT Data Decoder
D6020	Not Used		
D6021	1SS53	Si Diode	PLL SAT Data Decoder
D6022	Not Used		
D6023	1SS53	Si Diode	PLL NOR Data Decoder
D6024	Not Used		
D6025	1SS53	Si Diode	PLL NOR Data Decoder
X6001	27.4035MHz	Crystal	PLL Local Oscillator (HC-18/U3P)
X6002	6.4MHz	"	(HC-18/U) PLL Reference Oscillator
TH6001	31D26	Thermistor	Temperature Compensator (for Q6001)

50 MHz MODULE: PA UNIT

PART NO.	DEVICE	TYPE	FUNCTION
Q7001	M57735	IC	TX RF Power Amplifier
D7001	V06B	Si Diode	Reverse Voltage Protector (for RL7001)
D7002	1S1588	"	TX ALC Detector

FOR SERVICE MANUALS
CONTACT:
MAURITRON TECHNICAL SERVICES
www.mauritron.co.uk
TEL: 01844 - 351694
FAX: 01844 - 352554

144 MHz MODULE: RF UNIT

PART NO.	DEVICE	TYPE	FUNCTION
Q5001	3SK74L	MOS FET	RX RF Amplifier
Q5002	3SK51-03	"	RX 1st Mixer
Q5003	2SK125*	JFET	RX 1st IF Amplifier
Q5004	2SK241Y	"	TX 2nd Mixer
Q5005	"	"	"
Q5006	3SK70	MOS FET	TX RF Buffer Amplifier
Q5007	2SC2538	Transistor	TX RF Driver
Q5008	2SA733AQ	"	TX AFP Amplifier
Q5009	2SD471L	"	Regulator (TX 9V)
Q5010	"	"	" (")
Q5011	2SK125	JFET	" (")
D5001	MV13	Varistor Diode	Temperature Compensator (for Q5001)
D5002	1T25	Varactor Diode	RX Auto-Tune Circuit
D5006	1T25	Varactor Diode	RX Auto-Tune Circuit
D5007	1SS53	Si Diode	T/R Switch (RX Out)
D5008	"	"	" (TX In)
D5009	1T25	Varactor Diode	TX Auto-Tune Circuit
D5012	1T25	Varactor Diode	TX Auto-Tune Circuit
D5013	1S1555	Si Diode	Temperature Compensator (for Q5007)
D5014	1SS53	"	Temperature Compensator (for Q5008)
D5015	"	"	AFP-→ALC
D5016	1SS97	Schottky Barrier Di.	Switch (for PO Meter)
D5017	WZ090	Zener Diode	Regulator (TX 8V)
D5018	1SS53	Si Diode	" (")
D5019	V06B	"	Reverse Voltage Protector (for RL5001)
D5020	1SS97	Schottky Barrier Di.	Switch (ALC)
XF5001	10.8M30B	Crystal Filter	RX 1st IF Filter
TH5001	25D29	Thermistor	Temperature Compensator (RX Output Level)
TH5002	31D26	"	" (for TX Input Level)
TH5003	D22A	"	" (for Q5006)

144 MHz MODULE: PLL, VCO UNITS

PART NO.	DEVICE	TYPE	FUNCTION
Q6001	2SK192A-GR	JFET	PLL VCO (RX 1st, TX 2nd Local Oscillator)
Q6002	2SK241Y	"	VCO Buffer Amplifier
Q6003	3SK73Y	MOS FET	PLL Output Buffer Amplifier (RX 1st, TX 2nd Local)
Q6004	2SK241Y	JFET	PLL Buffer Amplifier
Q6005	SN16913P	IC	PLL Mixer

Q6006	2SC945AP	Transistor	PLL IF Buffer Amplifier
Q6007	"	"	"
Q6008	TC9122P	IC	PLL Programmable Divider
Q6009	TC5081AP	"	PLL Phase Detector
Q6010	2SC945AP	Transistor	PLL Active LPF
Q6011	"	"	"
Q6012	"	"	PLL VCO (Q6001) Band Switch
Q6013	2SC460B	"	PLL Local Oscillator
Q6014	2SC945AP	"	SAT VFO Buffer Amplifier
Q6015	"	"	NOR VFO Buffer Amplifier
Q6016	SN76514N	IC	PLL Local Premixer
Q6017	2SC535B	Transistor	PLL Local Buffer Amplifier
Q6018	2SC945AP	"	PLL Unlock Switch
Q6019	2SA564A	"	PLL Unlock Signal Amplifier
Q6020	2SC945AP	"	PLL Reference Oscillator
Q6021	MB84024B	IC	PLL Reference 1/64 Divider
Q6022	2SD892Q	Transistor	STBY Switch
Q6023	MC14081B	IC	NOR/SAT TX Select Data and Strobe Decoder
Q6024	MC14560B	"	VCO Band Decoder
Q6025	MC14094B	"	Latch (PLL Divider Data)
Q6026	2SC945AP	Transistor	Switch (")
Q6027	μPC78L05	IC	Regulator (+5V Line)
Q6028	MC14504B	"	PLL Divider Data Decoder
Q6029	2SC945AP	Transistor	VFO Selector (SAT VFO)
Q6030	"	"	" (NOR VFO)
Q6031	2SD892Q	"	Relay Driver (for RL6001)
Q6032	μPC7808H	IC	Regulator (+8V Line)
D6001	1T25	Varactor Diode	PLL VCO Control
D6002	"	"	"
D6003	1SS53	Si Diode	PLL VCO (Q6001) Band Switch
D6004	1T25	Varactor Diode	PLL Auto-Tune Circuit
D6005	1SS53	Si Diode	T/R Switch (RX Local)
D6006	"	"	" (TX Local)
D6007	"	"	VFO Selector (SAT VFO)
D6008	"	"	" (NOR VFO)
D6009	"	"	" (SAT VFO)
D6010	"	"	" (NOR VFO)
D6011	V06B	"	Reverse Voltage Protector (for Q6022)
D6012	1SS53	"	NOR TX STBY Decoder
D6013	"	"	SAT TX Decoder
D6014	"	"	NOR Strobe Decoder
D6015	"	"	SAT Strobe Decoder
D6016	V06B	"	Reverse Voltage Protector (for Q6031)
D6017	1SS53	"	PLL NOR Data Decoder
D6018	"	"	PLL SAT TX Decoder
D6019	"	"	PLL SAT Data Decoder
D6020	"	"	"
D6021	Not Used		
D6022	"		
D6023	1SS53	Si Diode	PLL NOR Data Decoder
D6024	"	"	"
D6025	"	"	"
D6026	"	"	"
X6001	60.7018MHz	Crystal (HC-18/U3P)	PLL Local Oscillator

X6002	6.4MHz	Crystal (HC-18/U)	PLL Reference Oscillator	TH5001	25D29	Thermistor	Temperature Compensator (RX Output Level)
TH6001	31D26	Thermistor	Temperature Compensator (for Q6001)	TH5002	31D26	"	" (for TX Input Level)

144 MHz MODULE: PA UNIT

PART NO.	DEVICE	TYPE	FUNCTION
Q7001	M57713	IC	TX RF Power Amplifier
D7001	V06B	Si Diode	Reverse Voltage Protector (for RL5001)
D7002	1SS97	Schottky Barrier Di.	TX ALC Detector

430/440 MHz MODULES: RF UNIT

PART NO.	DEVICE	TYPE	FUNCTION
Q5001	3SK121	GaAs FET	RX RF Amplifier
Q5002	2SK125	JFET	"
Q5003	ND487C1-3R	IC (Ring Module)	RX 1st Mixer
Q5004	3SK73Y	MOS FET	RX 1st IF Amplifier
Q5005	3SK51-03	"	RX 2nd Mixer
Q5006	2SK241Y	JFET	TX 2nd Mixer
Q5007	"	"	"
Q5008	3SK73Y	MOS FET	TX 2nd IF Buffer Amplifier
Q5009	ND487C2-3R	IC (Ring Module)	TX 3rd Mixer
Q5010	2SK125	JFET	TX RF Buffer Amplifier
Q5011	2SC2407	Transistor	TX RF Predriver
Q5012	2SC1426	"	TX RF Driver
Q5013	2SA733AQ	"	TX AFP Amplifier
Q5014	2SC2026	"	RX 1st/TX 3rd Local Buffer Amplifier
Q5015	2SC460B	"	2nd Local Oscillator
Q5016	"	"	2nd Local Buffer Amplifier
D5001	1SS53	Si Diode	T/R Switch (RX Out)
D5002	"	"	" (TX In)
D5003	"	"	Temperature Compensator (for Q5008)
D5004	1S1555	"	" (for Q5011)
D5005	"	"	" (for Q5012)
D5006	1SS53	"	" (for Q5013)
D5007	1SS97	Schottky Barrier Di.	Switch (for PO Meter)
D5008	1SS53	Si Diode	AFP → ALC
D5009	V06B	"	Reverse Voltage Protector (for RL5001)
D5010	MI301	PIN Diode	T/R Switch (RX 1st Local)
D5011	"	"	" (TX 3rd Local)
D5012	1SS53	Si Diode	" (RX 2nd Local)
D5013	"	"	" (TX 2nd Local)
D5014	1SS97	Schottky Barrier Di.	Switch (ALC)
X5001	56.805MHz	Crystal (HC-18/U3P)	2nd Local Oscillator
XF5001	XF-67JX	Crystal Filter	RX 1st IF Filter

430/440 MHz MODULES: PLL, VCO UNITS

PART NO.	DEVICE	TYPE	FUNCTION
Q6001	2SK192A-GR	JFET	PLL-1 VCO (RX 1st/TX 3rd Local Oscillator)
Q6002	2SK241Y	"	PLL-1 VCO Buffer Amplifier
Q6003	2SC2026	Transistor	PLL-1 Output Tripler (for RX 1st/TX 3rd Local)
Q6004	2SK241Y	JFET	PLL-1 VCO Buffer Amplifier
Q6005	SN16913P	IC	PLL-1 Mixer
Q6006	2SC945AP	Transistor	PLL-1 IF Buffer Amplifier
Q6007	"	"	"
Q6008	TC9122P	IC	PLL-1 Programmable Divider
Q6009	TC5082P	"	PLL-1 Reference Oscillator, 1/256 Divider
Q6010	TC5081AP	"	PLL-1 Phase Detector
Q6011	2SA733AQ	Transistor	PLL Unlock Signal Amplifier
Q6012	2SC945AP	"	PLL Unlock Switch
Q6013	2SC460B	"	PLL-2 Local Oscillator, x2 Multiplier
Q6014	SN16913P	IC	PLL-2 Mixer
Q6015	2SC945AP	Transistor	PLL-2 IF Buffer Amplifier
Q6016	MC145143P	IC	PLL-2 Phase Detector, Programmable Divider
Q6017	2SK192A-GR	JFET	PLL-2 VCO
Q6018	2SK241Y	"	PLL-2 VCO Buffer Amplifier
Q6019	"	"	"
Q6020	2SC945AP	Transistor	PLL-2 Reference (NOR VFO) Buffer Amplifier
Q6021	"	"	PLL-2 Reference (SAT VFO) Buffer Amplifier
Q6022	"	"	PLL-2 Reference (NOR VFO or SAT VFO) Buffer Amplifier
Q6023	TC9122P	IC	PLL-2 Reference (NOR VFO or SAT VFO) 1/96 Divider
Q6024	2SC945AP	Transistor	PLL-2 Reference Selector (NOR VFO)
Q6025	"	"	" (SAT VFO)
Q6026	2SD892Q	"	Relay Driver (for RL6001)
Q6027	μPC78L05	IC	Regulator (+5V Line)
Q6028	MC14094B	"	Latch (PLL-1 Divider Data)
Q6029	MC14504B	"	PLL-1 Divider Data Decoder
Q6030	MC14081B	"	NOR/SAT TX Select Data and Strobe Decoder
Q6031	2SD892Q	Transistor	STBY Switch
Q6032	2SC945AP	"	Switch (PLL-1 Divider Data)
Q6033	μPC7808H	IC	Regulator (+8V Line)
D6001	1T25	Varactor Diode	PLL-1 (RX 1st/TX 3rd Local Oscillator)
D6002	"	"	" (")
D6003	1SS53	Si Diode	PLL-1 Unlock Switch
D6004	"	"	PLL-2 Unlock Switch
D6005	1T25	Varactor Diode	PLL-2 VCO

D6006	1SS53	Si Diode	PLL-2 Reference Selector (NOR VFO)
D6007	"	"	" (")
D6008	"	"	" (SAT VFO)
D6009	"	"	" (")
D6010	V06B	"	Reverse Voltage Protector (for Q3026)
D6011	1SS53	"	PLL NOR Data Decoder
D6012	"	"	PLL SAT TX Decoder
D6013	"	"	NOR Strobe Decoder
D6014	"	"	SAT Strobe Decoder
D6015	"	"	SAT TX Decoder
D6016	"	"	NOR TX STBY Decoder
D6017	V06B	"	Reverse Voltage Protector (for Q6031)
D6018	1SS53	"	PLL NOR Data Decoder
D6019	"	"	"
D6020	Not Used		
D6021	1SS53	Si Diode	PLL NOR Data Decoder
D6022	"	"	PLL SAT Data Decoder
D6023	"	"	"
D6024	"	"	"
D6025	"	"	"
X6001	8.5333MHz	Crystal	PLL-2 Local Oscillator (HC-18/U)
X6002	57.4333MHz	"	PLL-1 Reference Oscillator (HC-18/U3P)
TH6001	31D26	Thermistor	Temperature Compensator (for Q6001)
TH6002	"	"	" (for Q6017)
PTH 6001	PTH-2928	Posistor	Temperature Compensator (for X6002)

430/440 MHz MODULES: PA UNIT

PART NO.	DEVICE	TYPE	FUNCTION
Q7001	S-AU4	IC	TX RF Power Amplifier
D7001	V06B	Si Diode	Reverse Voltage Protector (for RL7001)
D7002	1SS97	Schottky Barrier Di.	TX ALC Detector

FOR SERVICE MANUALS
CONTACT:
MAURITRON TECHNICAL SERVICES
www.mauritron.co.uk
TEL: 01844 - 351694
FAX: 01844 - 352554

RX UNIT PARTS LAYOUT

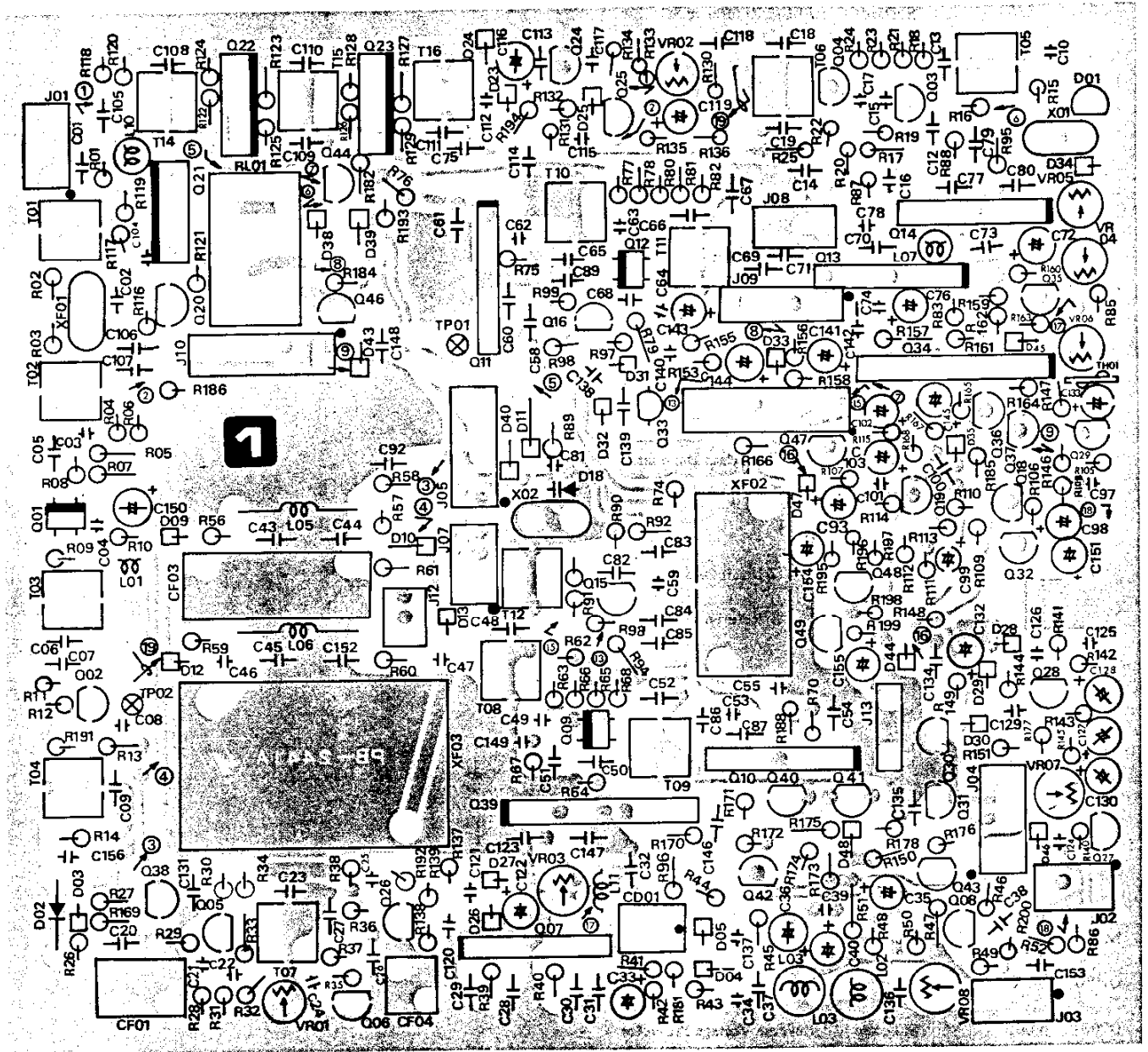

Viewed from component side

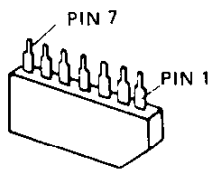

μ PC577H
 μ PC1037H

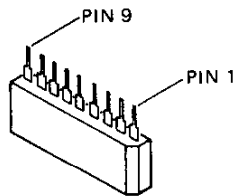

AN6561

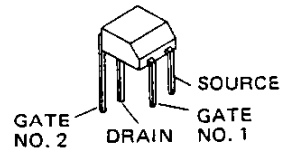

3SK73Y

RX UNIT PARTS LAYOUT

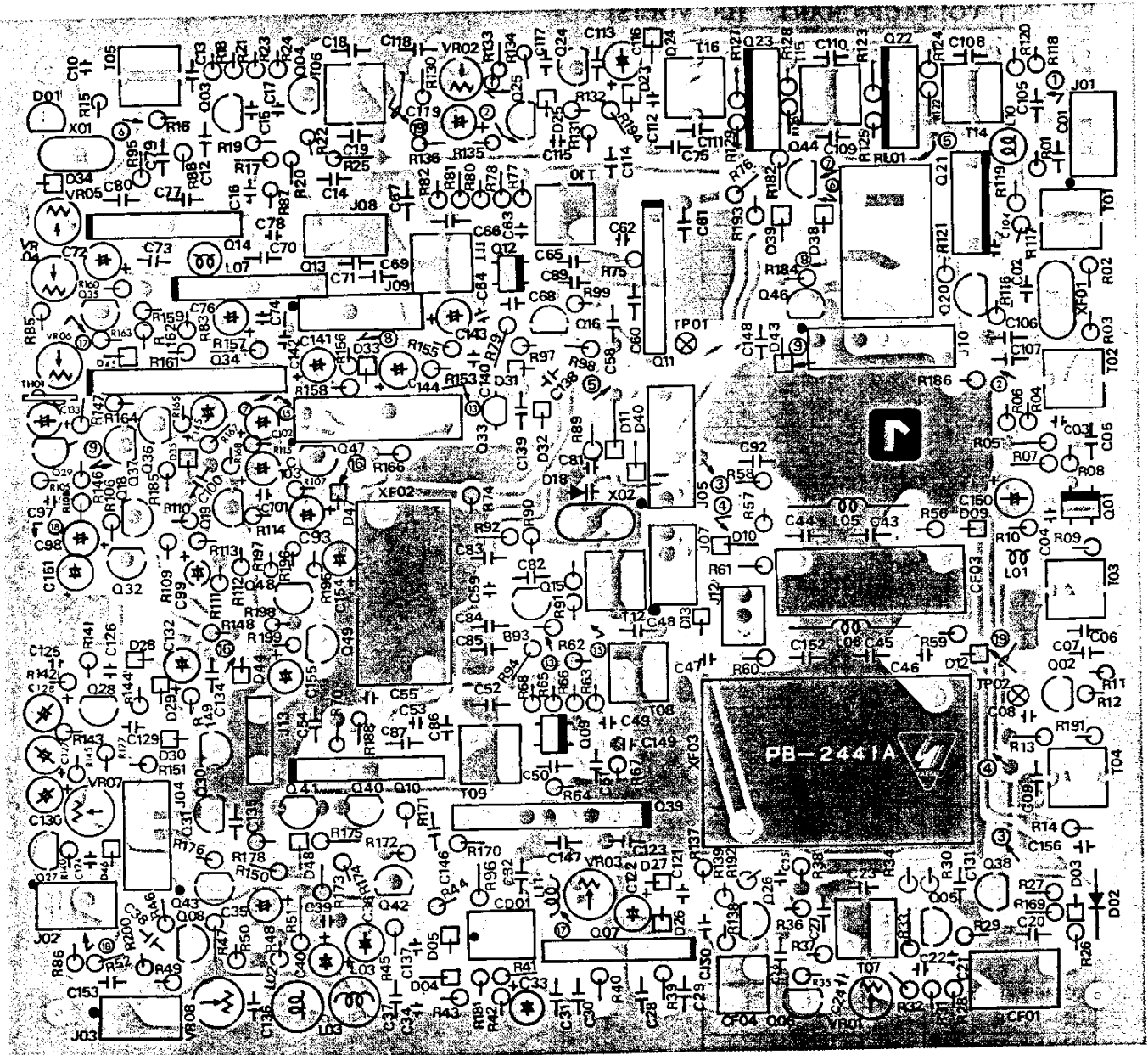

FOR SERVICE MANUALS
CONTACT:

MAURITRON TECHNICAL SERVICES

www.mauritron.co.uk
TEL: 01844 - 351694
FAX: 01844 - 352554

Viewed from solder side

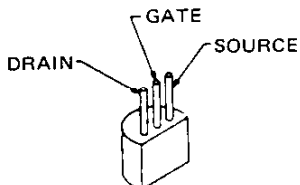

2SK125

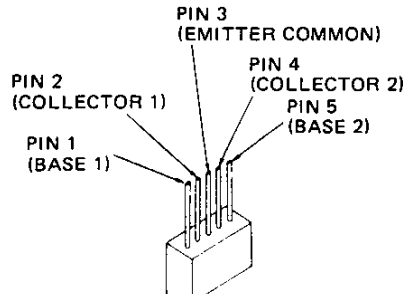

2SC1583

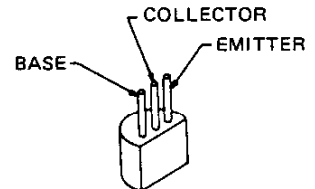

- | | |
|---------|-----------|
| 2SA733 | 2SC945AP |
| 2SC460B | 2SC1815BL |
| 2SC535B | 2SC1815GR |

RX UNIT VOLTAGE CHART (DC VOLTS)

	E(S)	C(D)	B(G1)	(G2)	REMARKS
Q2001	1.4	8.1	1.5	2.4	
Q2002	2.9	7.7	0		
Q2003	3.6	7.8	3.6		
Q2004	0.8	7.8	1.5		
Q2005	0.9	7.9	1.6		
Q2006	0	3.3	0.7		
Q2008	0.6	1.6	1.2		
Q2009	1.5	7.2	1.6	3.0	
Q2012	1.5	7.2	1.6	3.0	
Q2015	3.0	7.4	3.6		
Q2016	5.5	7.8	6.0		
Q2018	0.8	4.7	1.4		
Q2019	3.6	7.9	4.1		
Q2020	3.7	7.7	4.4		
Q2021	2.1	7.7	3.2		
Q2022	2.6	7.9	3.2		
Q2023	1.9	7.9	2.5		
Q2024	0	6.4	0.4		
Q2025	0	2.4	0		
Q2026	0	0	0		
Q2027	0	0.2	0.2		
Q2028	0.2	0	0		
Q2029	0	1.4	0.8		
Q2030	0	0.1	0.6		
Q2031	0	0.1	0.1		
Q2032	0	12.1	0.4		
Q2033	0	3.2	0		
Q2035	3.2	0	3.3		
Q2036	0	0	0.6		
Q2037	0	5.6	0		
Q2038	8.1	7.9	8.0		
Q2040	4.2	7.9	4.0		
Q2041	4.2	0	4.0		
Q2042	7.9	0	7.9		
Q2043	3.8	0.1	3.1		
Q2044	8.1	7.5	7.3		
Q2046	0	13.7	0		
Q2047	0	0	0		
Q2048	3.2	7.9	3.8		

FOR SERVICE MANUALS
CONTACT:
MAURITRON TECHNICAL SERVICES
www.mauritron.co.uk
TEL: 01844 - 351694
FAX: 01844 - 352554

	1	2	3	4	5	6	7	8	9	REMARKS
Q2007	5.2	1.6	1.6	0	4.1	2.6	7.7			
Q2010	6.7	5.9	5.5	0	2.9	2.9	2.9			
Q2011	6.5	5.6	4.8	0	3.0	3.0	3.0			
Q2013	7.2	6.3	5.9	0	3.2	3.2	3.2			
Q2014	6.9	6.0	5.3	0	3.1	3.1	3.1			
Q2034	8.1	6.8	2.3	2.7	0	2.9	3.2	3.2	8.1	
Q2039	7.9	4.2	4.2	4.2	0	4.2	4.2	4.1	7.9	

RX UNIT SCHEMATIC DIAGRAM

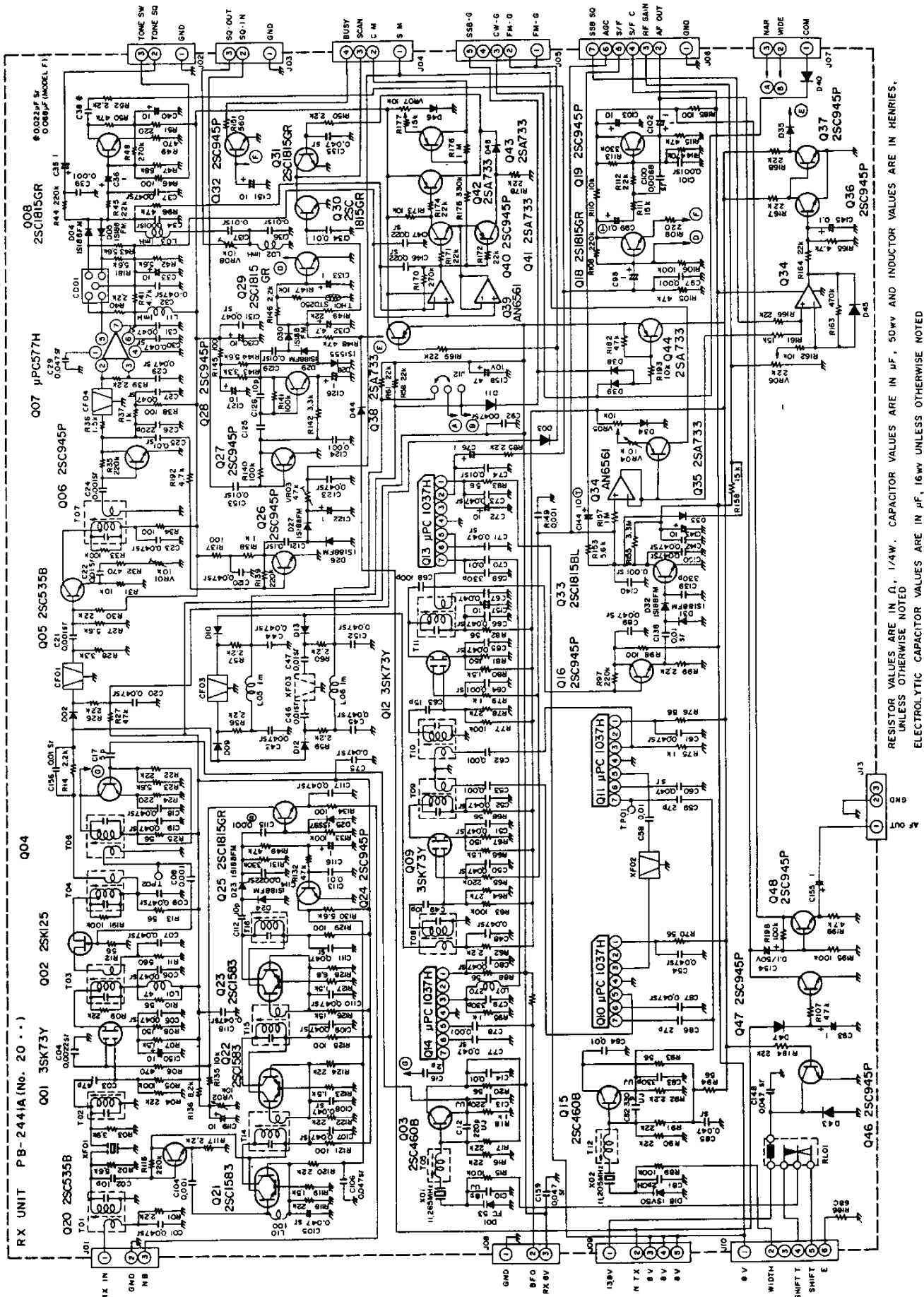

RESISTOR VALUES ARE IN Ω , 1/4W. CAPACITOR VALUES ARE IN μ F, 50WV AND INDUCTOR VALUES ARE IN HENRIES, UNLESS OTHERWISE NOTED
 ELECTROLYTIC CAPACITOR VALUES ARE IN μ F, 16WV UNLESS OTHERWISE NOTED
 DIODES ARE TYPE 1S553 UNLESS OTHERWISE NOTED

TX UNIT PARTS LAYOUT

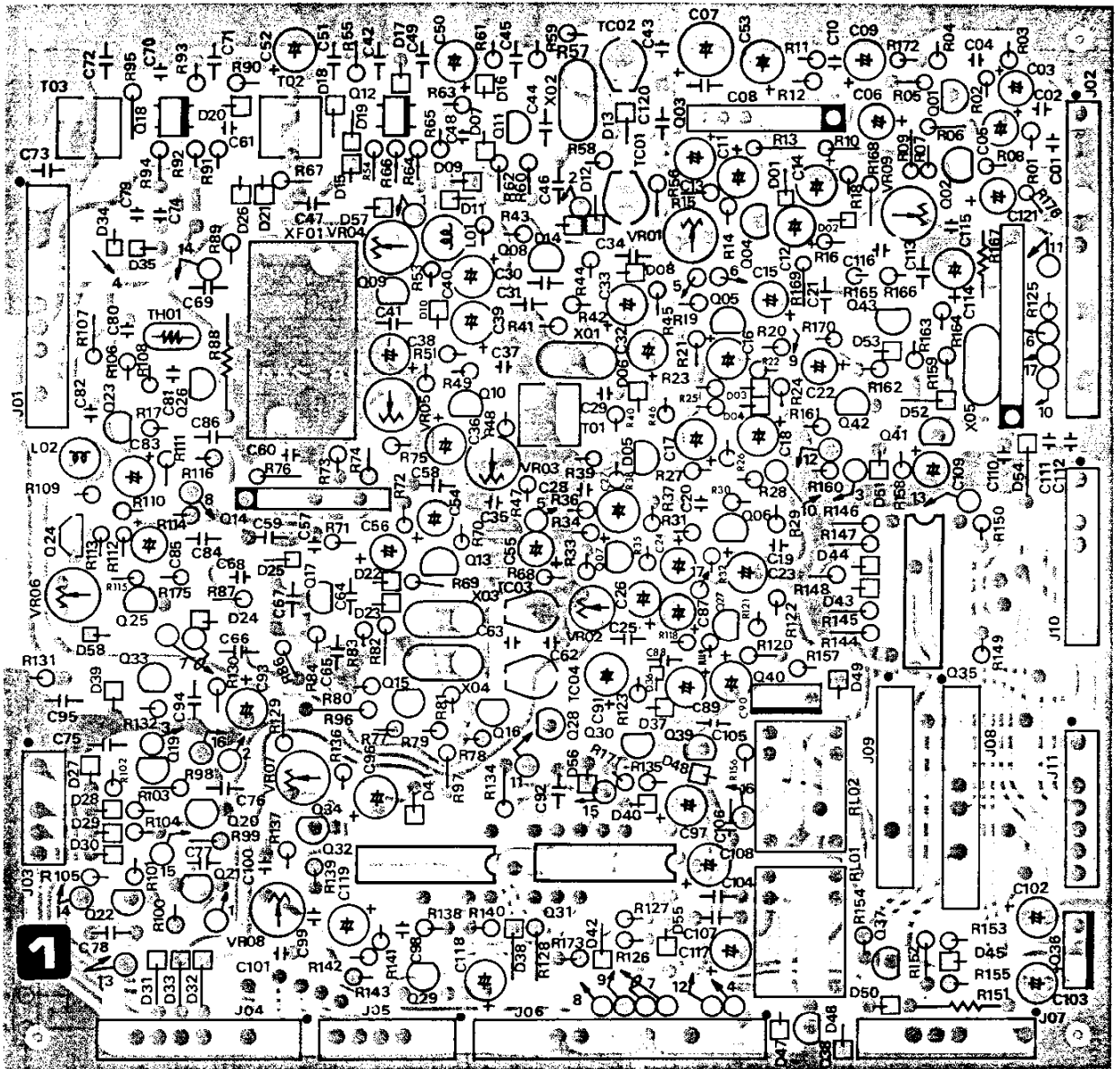

Viewed from component side

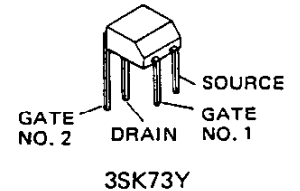
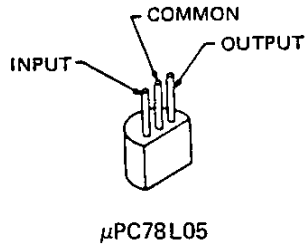
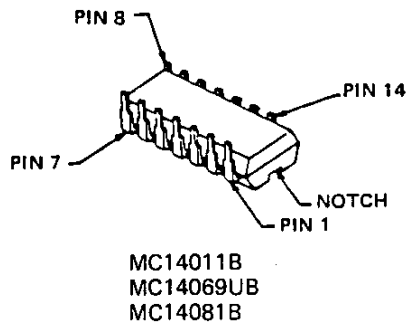
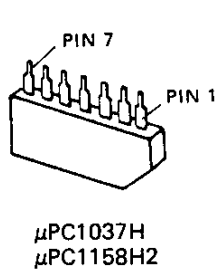

TX UNIT PARTS LAYOUT

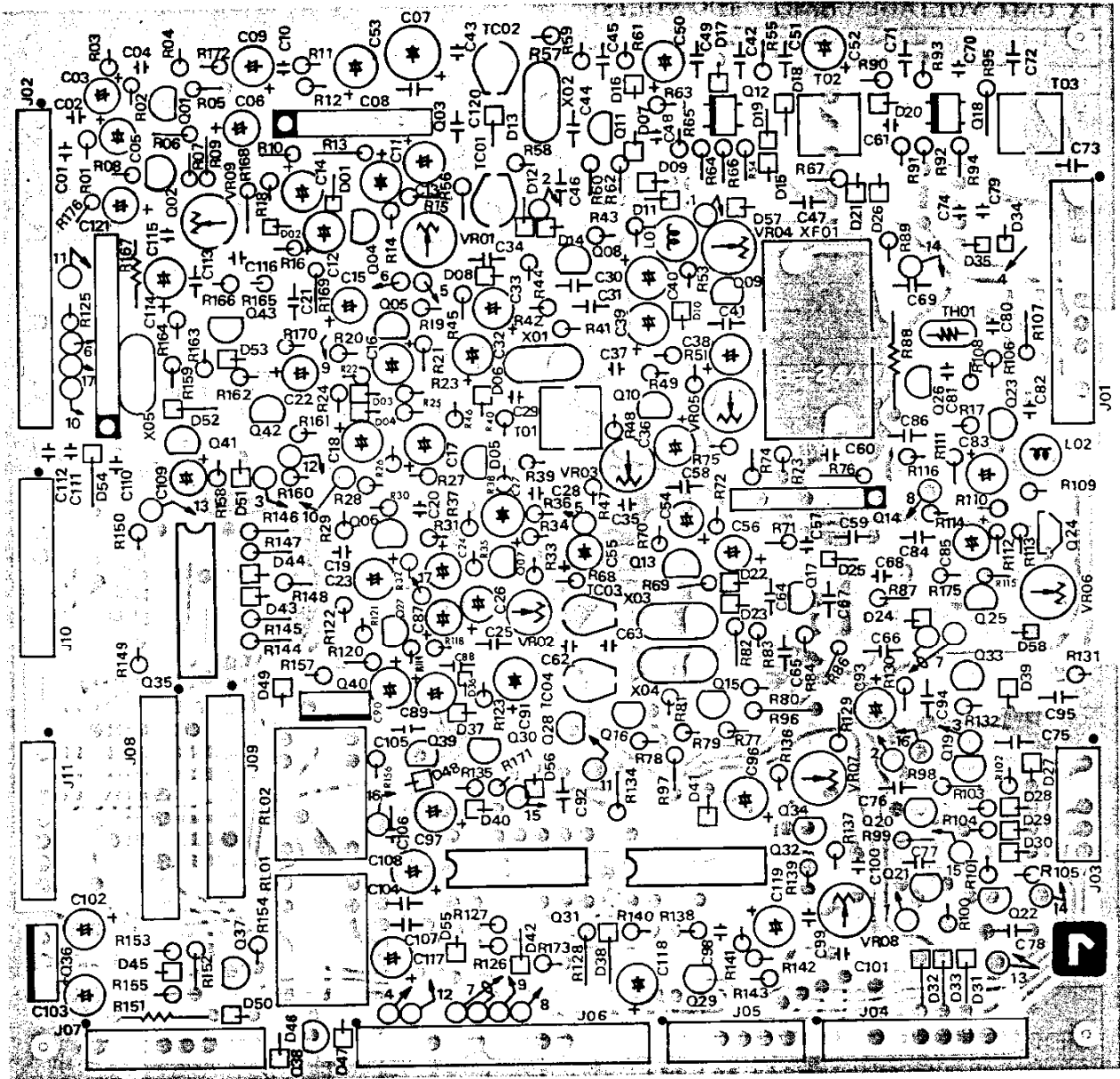

Viewed from solder side

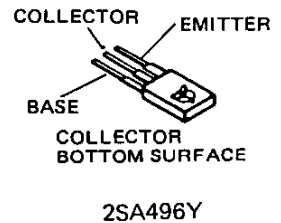
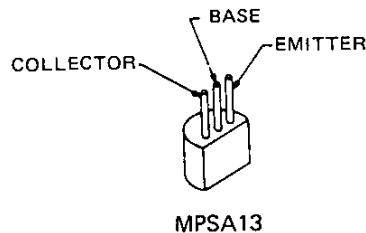
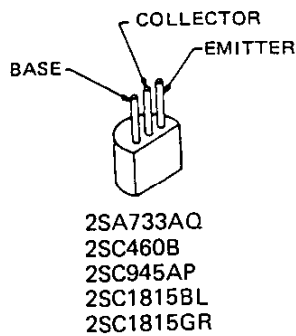
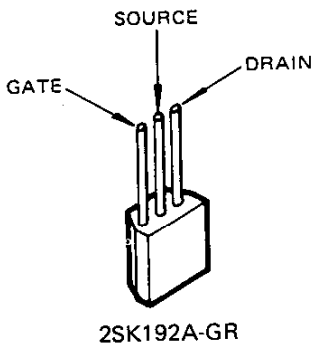

FOR SERVICE MANUALS
CONTACT:
MAURITRON TECHNICAL SERVICES

www.mauritron.co.uk
TEL: 01844 - 351694
FAX: 01844 - 352554

TX UNIT VOLTAGE CHART (DC VOLTS)

	E(S)	C(D)	B(G1)	(G2)	REMARKS
Q1001	0	2.8	0.7		
Q1002	1.7	5.9	2.2		
Q1004	3.0	7.7	3.6		
Q1005	0.1	3.7	0.7		
Q1006	3.5	7.8	4.0		
Q1007	0.2	3.7	0.8		
Q1008	1.6	4.2	2.2		
Q1011	5.2	7.8	5.2		
Q1012	3.9	7.0	1.3	3.7	
Q1013	2.9	7.9	3.5		
Q1015	8.1	0	8.1		
Q1016	8.1	0	8.1		
Q1017	3.2	7.9	3.6		
Q1018	1.4	7.6	1.4	2.5	
Q1019	8.1	8.0	7.4		
Q1021	8.1	8.0	7.4		
Q1022	8.1	8.0	7.4		
Q1023	0	2.5	0		DRIVE MIN
Q1024	5.0	8.1	2.3		DRIVE MIN
Q1025	5.5	0	4.8		DRIVE MIN
Q1027	0.2	3.9	0.8		
Q1028	0	12.2	0		
Q1029	0	0	0.7		
Q1030	0	0	0.3		
Q1033	0.7	3.3	0		
Q1034	0	7.9	0		
Q1037	0	1.3	0		
Q1038	0	0.7	1.3		
Q1039	0	8.1	0		
Q1040	8.1	8.1	7.3		
Q1041	0.1	0.2	0.6		
Q1042	0.1	7.9	0		
Q1043	7.9	7.8	7.2		

	1	2	3	4	5	6	7	8	9	10	11	12	13	14	REMARKS
Q1003	1.3	0.8	3.5	0	0	0	7.7								
Q1014	8.0	7.0	6.6	0	3.6	3.0	3.5								
Q1031	0	7.9	8.0	0	7.8	8.1	0	3.7	7.2	3.9	8.1	0	7.2	8.1	
Q1032	0.8	7.9	7.9	0	8.0	0	0	3.9	4.2	4.2	3.9	0	7.4	8.1	
Q1035	0	0	0	0	0	0	0	0	4.8	0	4.8	4.8	4.9	4.9	
Q1036	4.9	0	8.1												
Q1044	2.2	3.0	3.2	3.7	7.5	3.7	3.7	3.7	0						

FOR SERVICE MANUALS
 CONTACT:
MAURITRON TECHNICAL SERVICES
 www.mauritron.co.uk
 TEL: 01844 - 351694
 FAX: 01844 - 352554

VFO UNIT PARTS LAYOUT

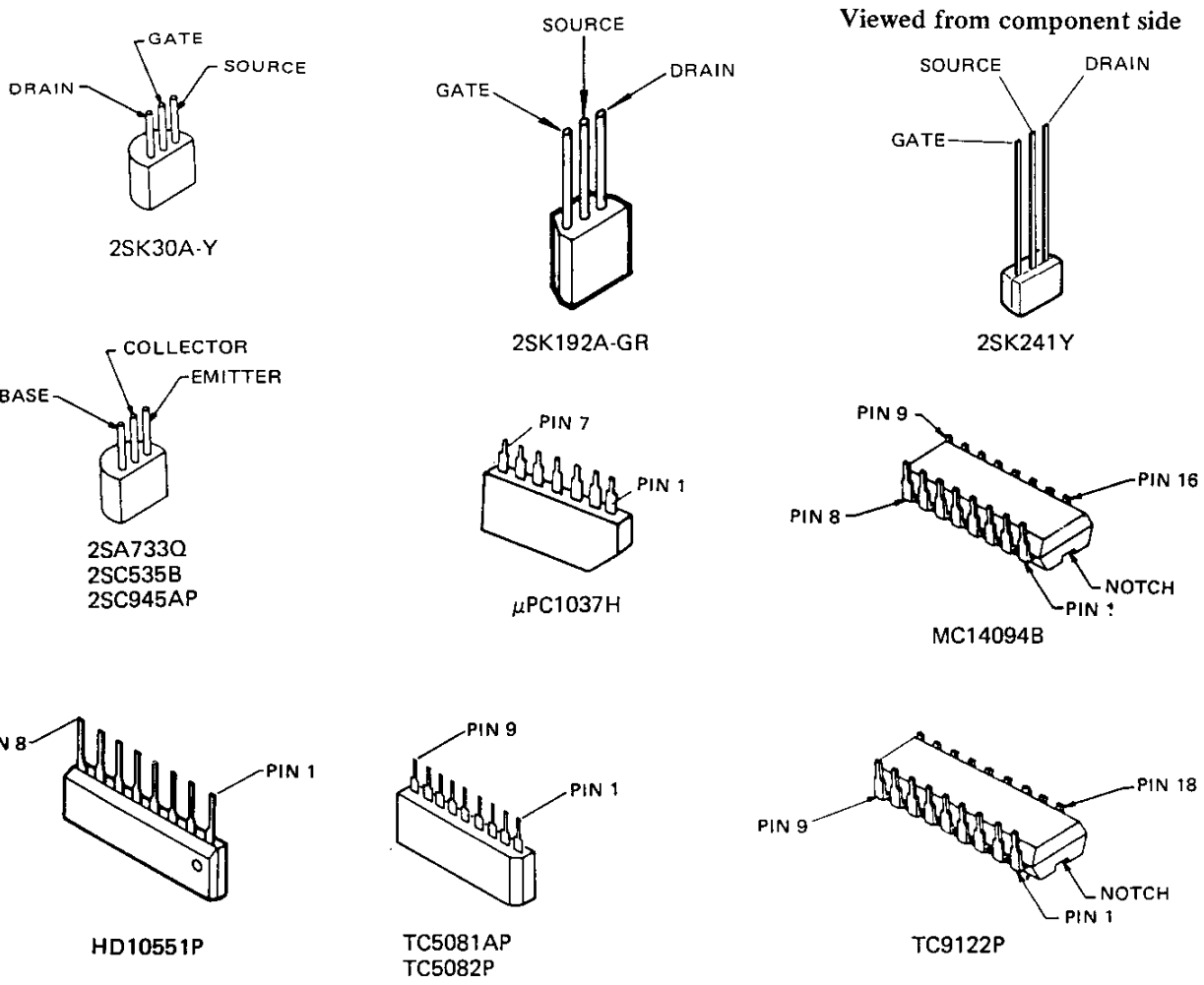
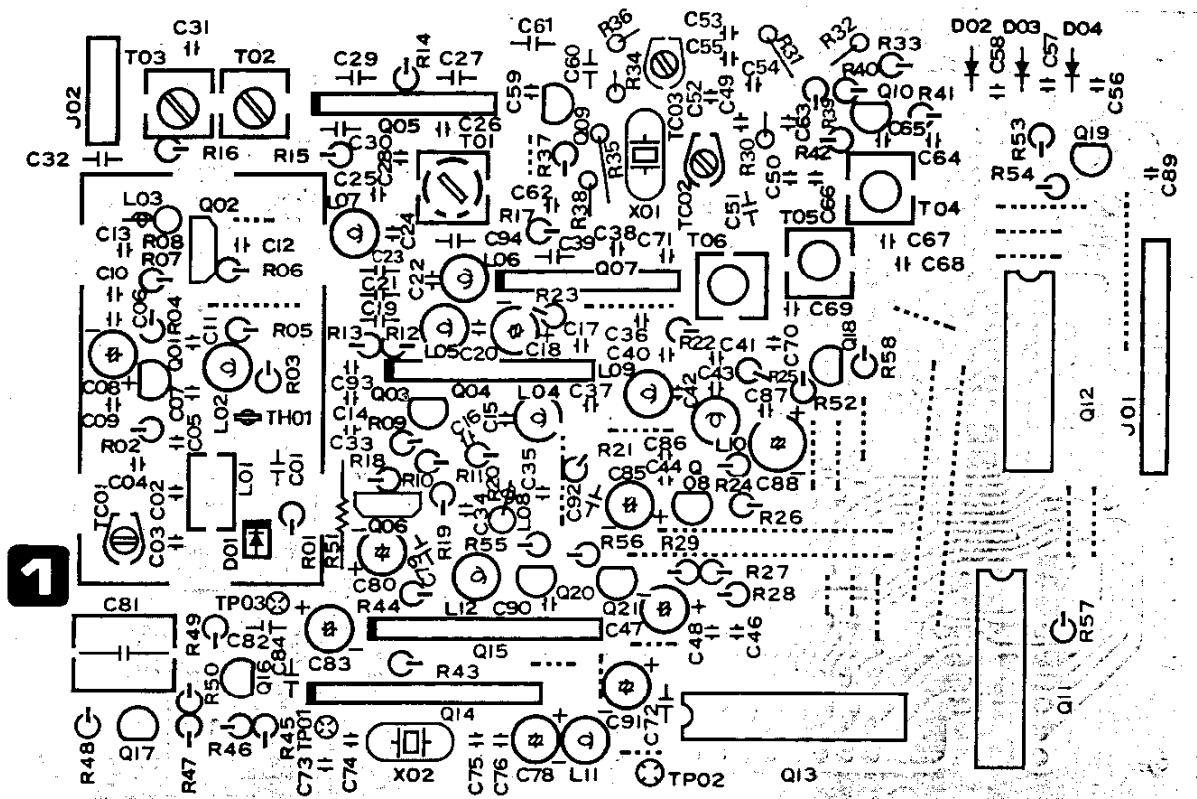

VFO UNIT PARTS LAYOUT

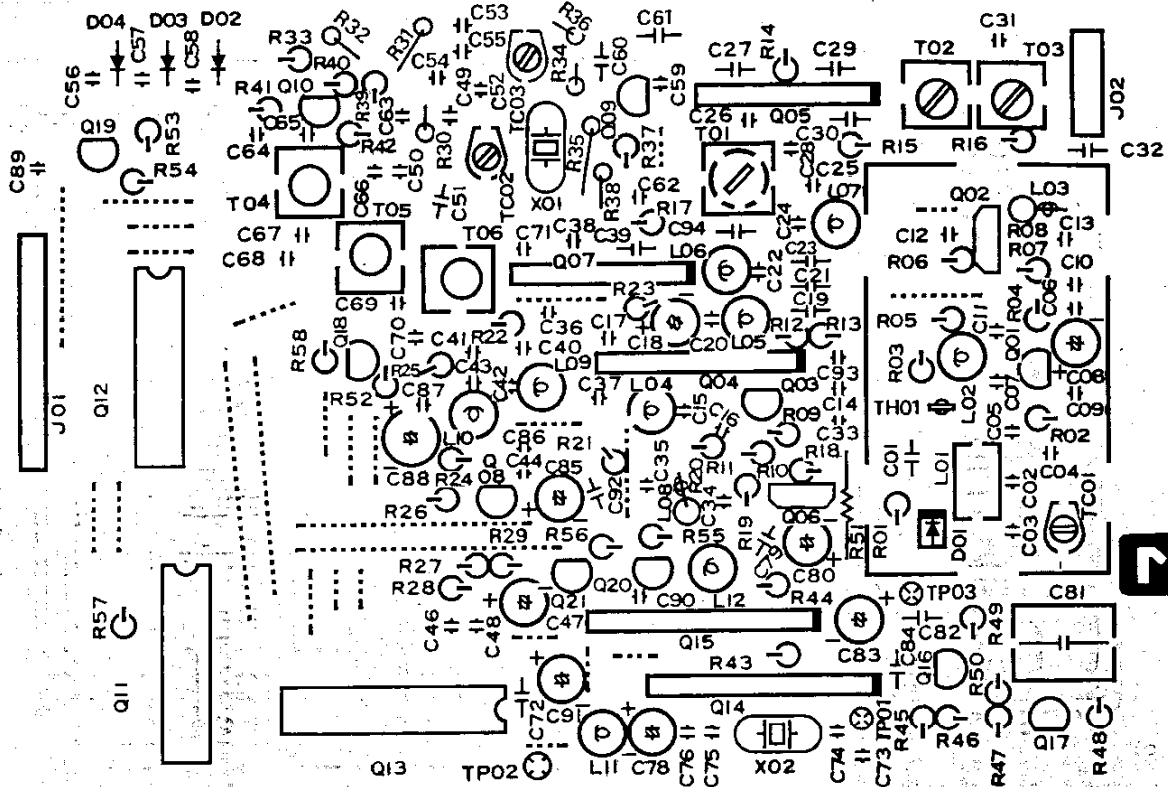

Viewed from solder side

VFO UNIT VOLTAGE CHART (DC VOLTS)

	E(S)	C(D)	B(G1)	REMARKS
Q101	1.0	7.7	0	
Q102	0.5	7.8	0	
Q103	0	4.8	0.7	
Q106	0.5	7.9	0	
Q108	0.1	3.9	0.8	
Q109	2.0	6.2	1.9	
Q110	1.7	7.0	1.7	
Q116	1.8	7.5	1.7	
Q117	0	3.8	0.6	
Q118	0	4.3	0	
Q119	0	0	0.6	
Q120	4.9	0	4.9	
Q121	0	0.3	0	

FOR SERVICE MANUALS
CONTACT:
MAURITRON TECHNICAL SERVICES
www.mauritron.co.uk
TEL: 01844 - 351694
FAX: 01844 - 352554

	1	2	3	4	5	6	7	8	9	10	11	12	13	14	15	16	REMARKS
Q104	0	0	2.6	4.9	0	0	4.9	2.7									
Q105	7.0	6.2	5.5	0	3.1	3.1	3.1										
Q107	7.2	6.3	5.8	0	3.2	3.2	3.2										
Q111	0	4.9	4.9	4.9	0	0	0	0	0	0	0	0	0	4.9	4.9		
Q112	0	0	4.9	0	0.2	0	0.2	0	0	4.9	0	4.9	0	4.9	4.9	4.9	

VFO UNIT SCHEMATIC DIAGRAM

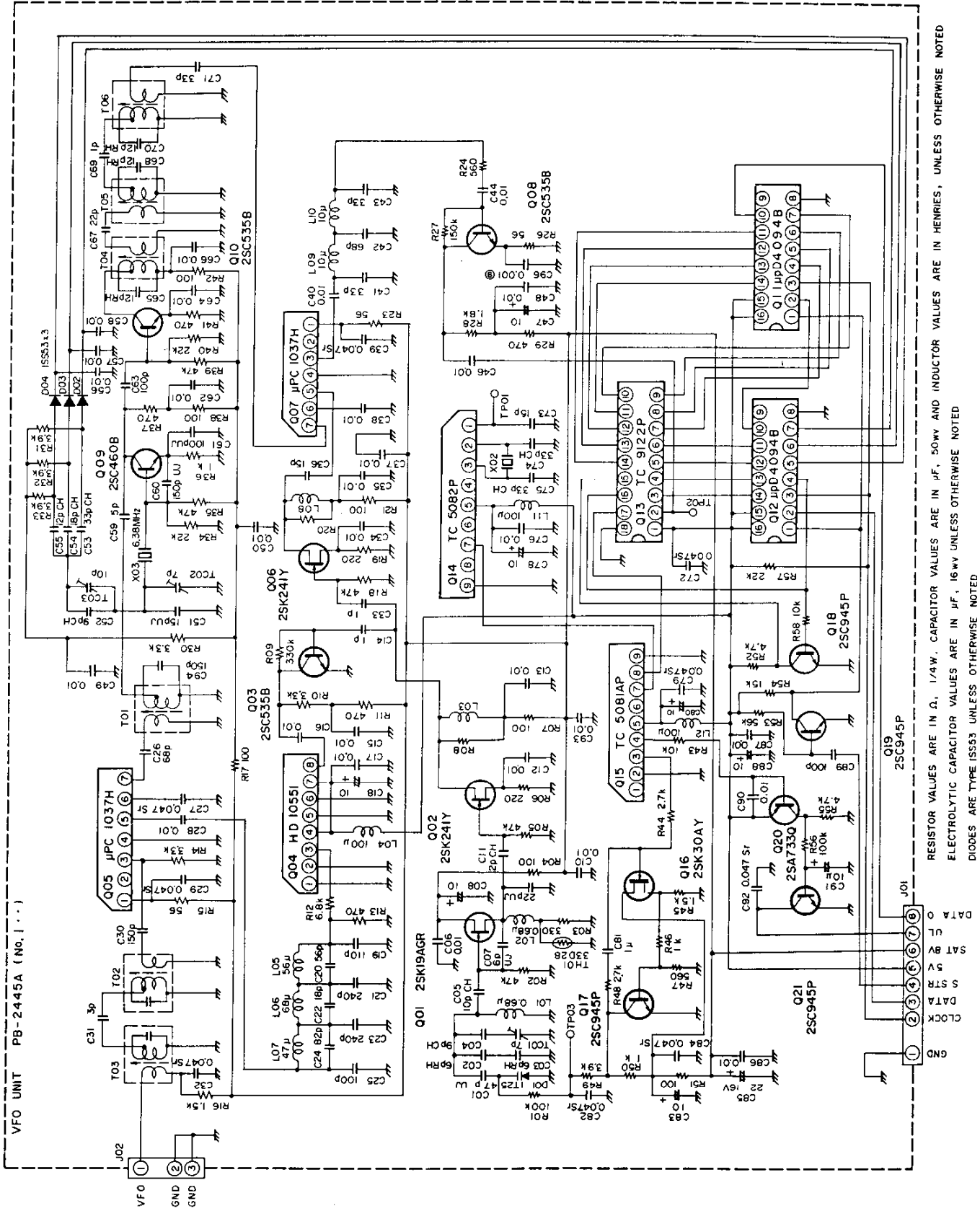

AF UNIT

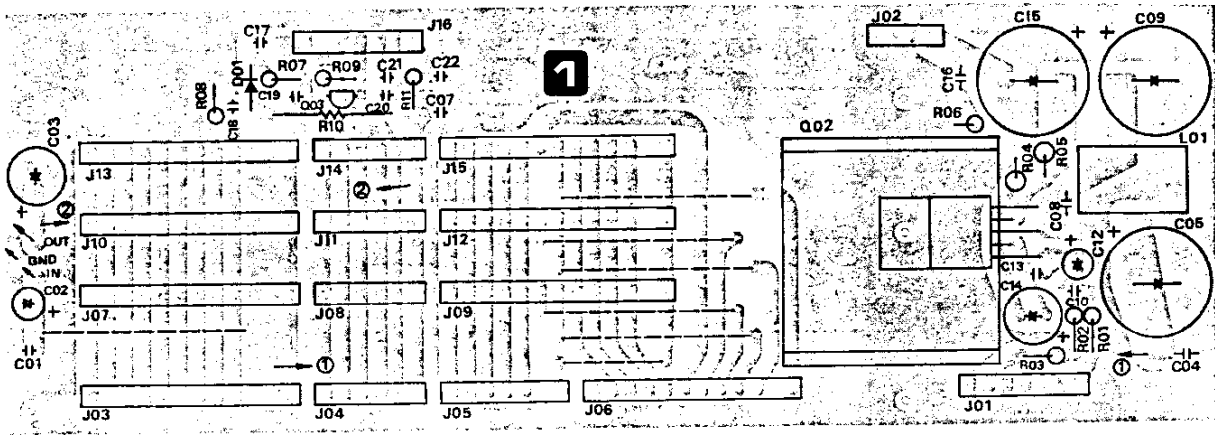

Viewed from component side

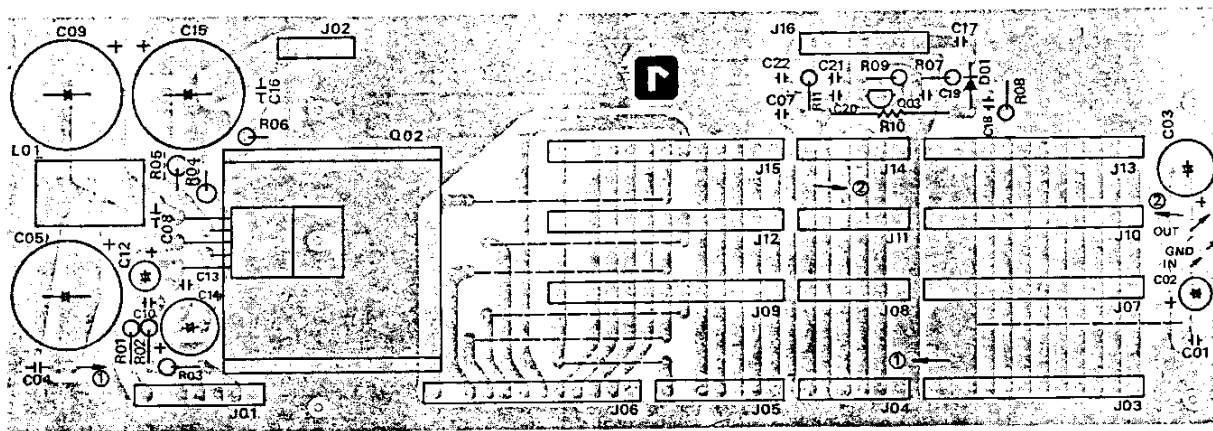

Viewed from solder side

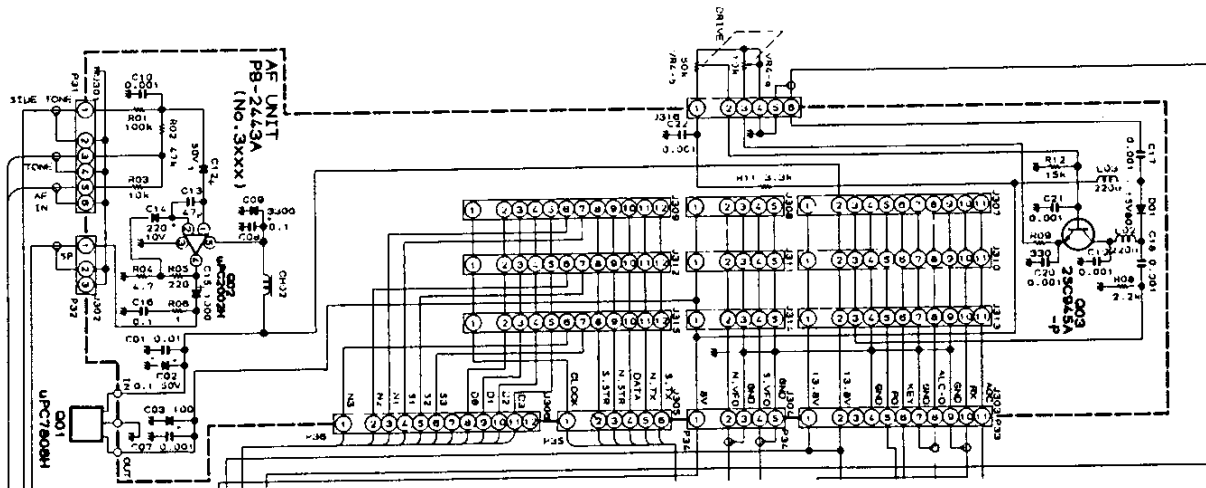

AF UNIT VOLTAGE CHART (DC VOLTS)

	E(S)	C(D)	B(G1)	REMARKS
Q303	0	7.8	0	

	1	2	3	4	5
Q302	0.7	0	0	0	13.7

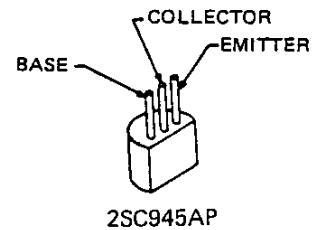
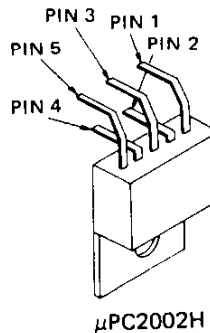

SAT UNIT PARTS LAYOUT

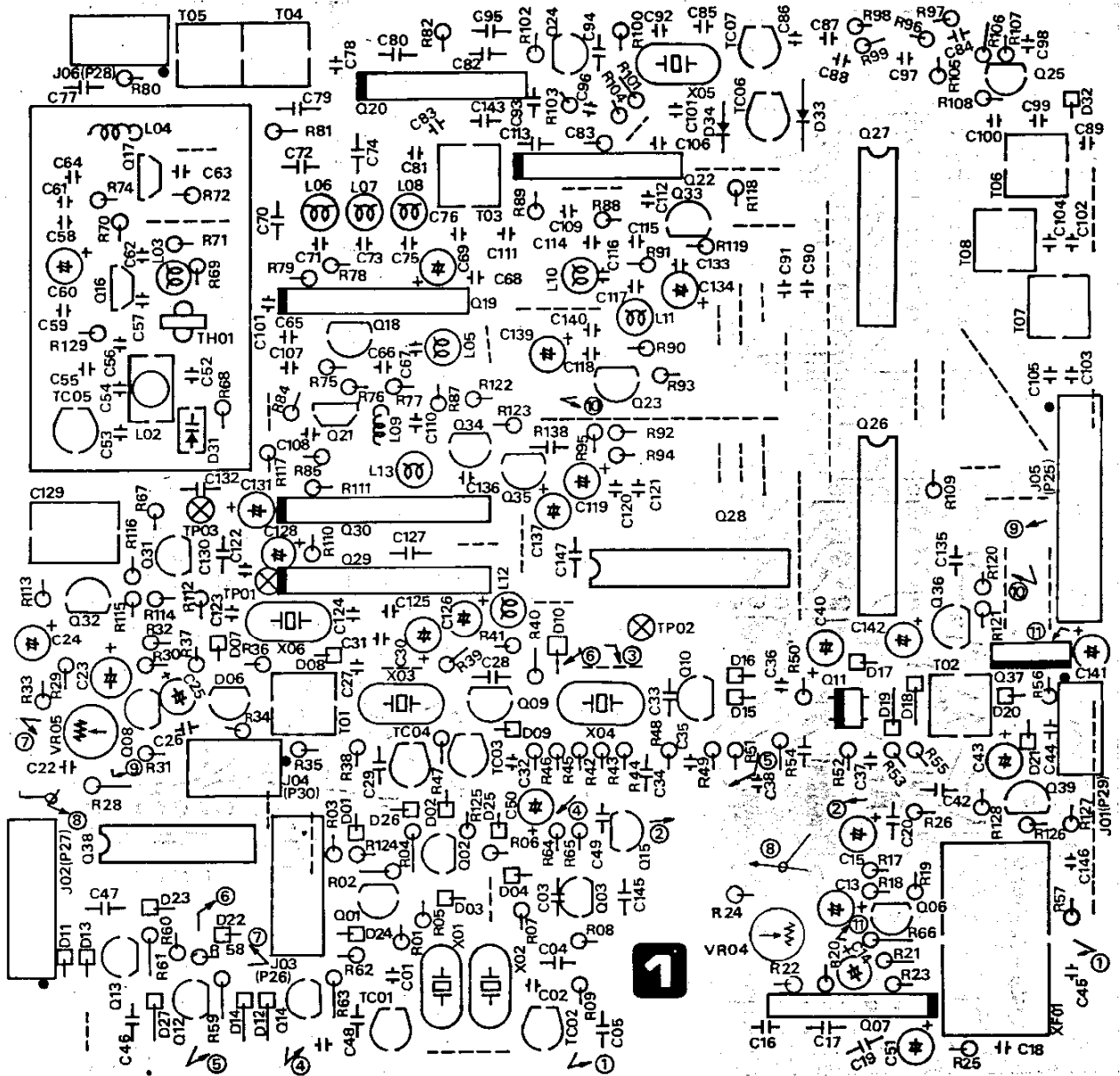

Viewed from component side

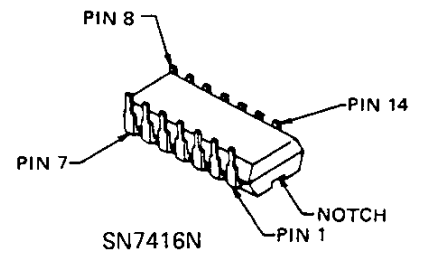
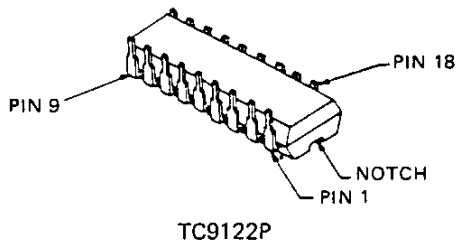
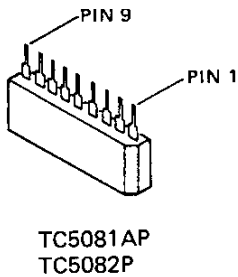
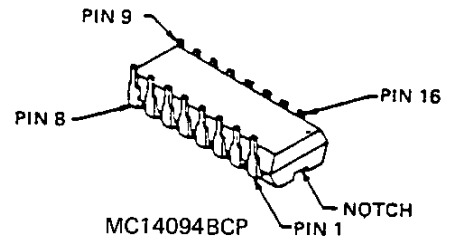
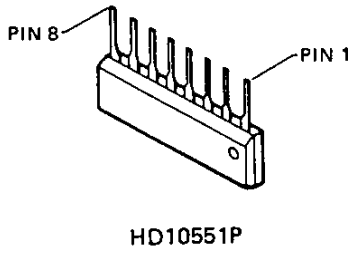
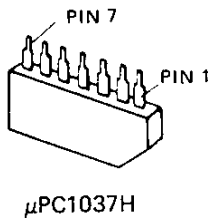

SAT UNIT PARTS LAYOUT

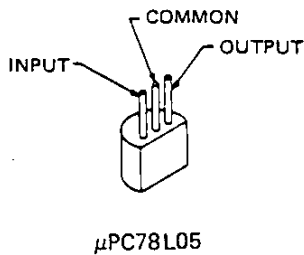
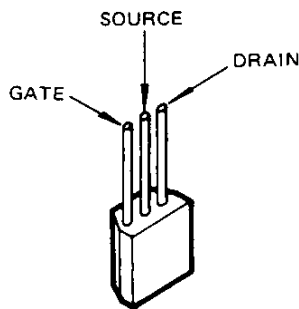
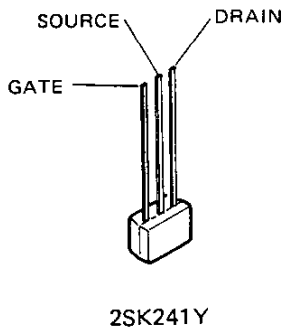
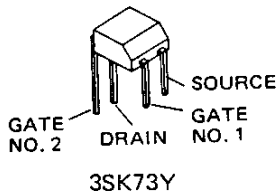
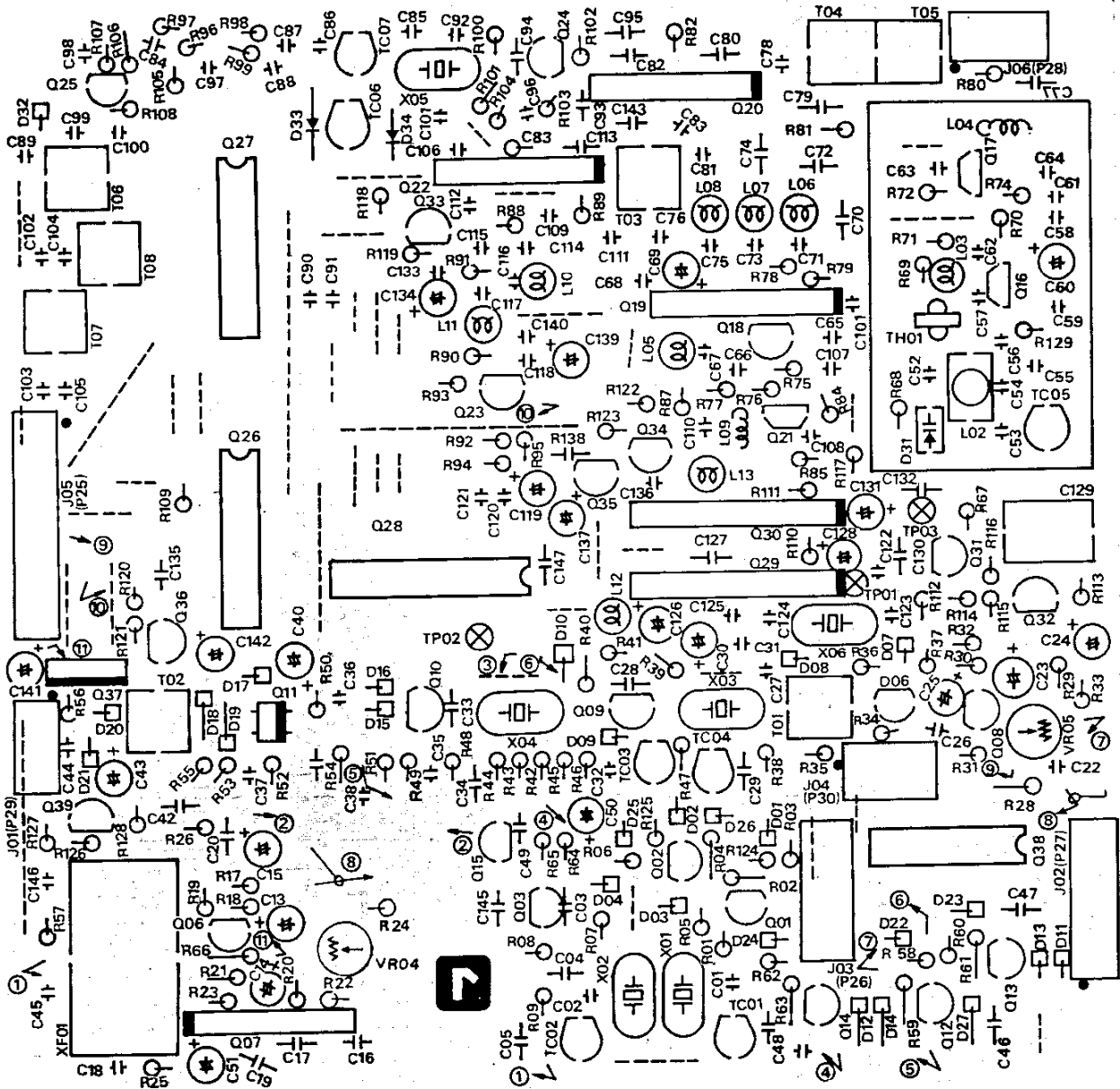

Viewed from solder side

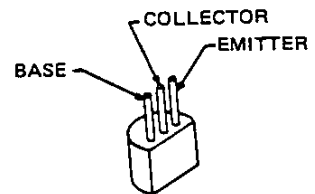
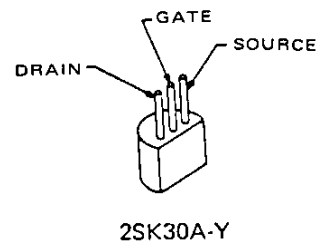

2SA733AQ 2SC535B
2SC460B 2SC945AP

SAT UNIT VOLTAGE CHART (DC VOLTS)

	E(S)	C(D)	B(G1)	(G2)	REMARKS
Q4001	8.0	0	7.5		
Q4002	8.0	7.9	7.3		
Q4003	3.7	7.8	3.5		
Q4006	2.7	7.6	3.1		
Q4008	0.2	3.5	0.8		
Q4009	1.6	4.1	2.2		
Q4010	3.7	7.3	3.5		
Q4011	1.6	6.7	1.2	3.5V	
Q4012	7.9	7.8	7.3		
Q4014	8.0	7.9	7.3		
Q4015	8.0	7.9	7.3		
Q4016	0.8	7.6	0		
Q4017	0.4	7.8	0		
Q4018	0	4.2	0.7		
Q4021	0.5	7.7	0		
Q4023	0.1	3.9	0.8		
Q4024	1.8	6.2	2.1		
Q4025	1.6	7.0	1.8		
Q4031	1.8	7.4	1.8		
Q4032	0	3.7	0.6		
Q4033	0.6	5.0	0		
Q4034	5.0	0	4.9		
Q4035	0	1.3	0.1		
Q4036	0	0.1	0.7		
Q4039	0	0.2	0.2		

FOR SERVICE MANUALS
 CONTACT:
MAURITRON TECHNICAL SERVICES
www.mauritron.co.uk
 TEL: 01844 - 351694
 FAX: 01844 - 352554

	1	2	3	4	5	6	7	8	9	10	11	12	13	14	15	16	17	18	REMARKS
Q4007	7.8	0.7	6.4	0	3.5	3.4	3.4												
Q4019	0	0	2.2	4.9	0	0	4.9	2.8											
Q4020	7.0	6.1	5.4	0	3.1	3.1	3.1												
Q4022	7.0	6.2	5.7	0	3.2	3.2	3.2												
Q4026	0.1	4.9	4.9	4.9	4.9	0	0	0	0	0	0	0	0	0	5.0	4.9			
Q4027	0.1	0	4.9	0	0	4.9	0	0	0	4.9	0	0	0	0	5.0	4.9			
Q4028	5.0	2.0	0	0	0	0	4.9	4.9	0	0	0	0	0	0	4.4	0	0	0	
Q4029	1.3	2.3	2.4	2.5	5.0	2.5	2.5	2.4	0										
Q4030	5.0	0	1.8	5.0	5.0	-	2.5	0	0										
Q4037	5.0	0	7.9																
Q4038	3.9	0.1	1.8	0.1	0.1	7.5	0	12.7	0.1	12.6	0.1	1.2	0	4.9					

SAT UNIT SCHEMATIC DIAGRAM

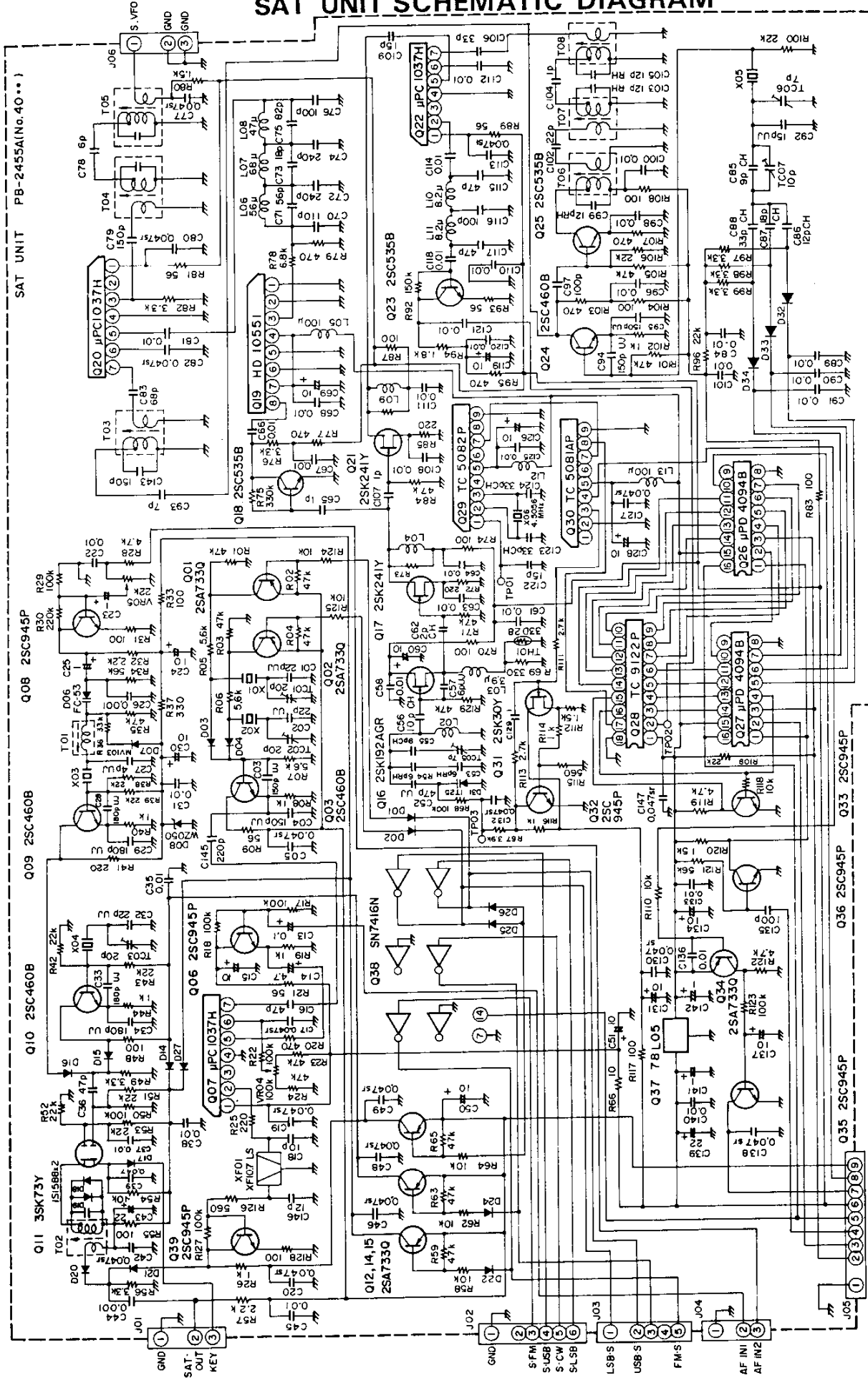

RESISTOR VALUES ARE IN Ω , 1/4W.
 CAPACITOR VALUES ARE IN μ F, 50WV AND
 INDUCTOR VALUES ARE IN HENRIES,
 UNLESS OTHERWISE NOTED
 ELECTROLYTIC CAPACITOR VALUES ARE
 IN μ F, 16WV UNLESS OTHERWISE NOTED
 DIODES ARE TYPE 1SS53 UNLESS OTHERWISE NOTED

- 1 GND
- 2 AF IN1
- 3 AF IN2
- 4 FMS
- 5 USB S
- 6 USB S
- 7 LSBS
- 8 LSBS
- 9 LSBS
- 10 LSBS
- 11 LSBS
- 12 LSBS
- 13 LSBS
- 14 LSBS
- 15 LSBS
- 16 LSBS
- 17 LSBS
- 18 LSBS
- 19 LSBS
- 20 LSBS
- 21 LSBS
- 22 LSBS
- 23 LSBS
- 24 LSBS
- 25 LSBS
- 26 LSBS
- 27 LSBS
- 28 LSBS
- 29 LSBS
- 30 LSBS
- 31 LSBS
- 32 LSBS
- 33 LSBS
- 34 LSBS
- 35 LSBS
- 36 LSBS
- 37 LSBS
- 38 LSBS
- 39 LSBS
- 40 LSBS
- 41 LSBS
- 42 LSBS
- 43 LSBS
- 44 LSBS
- 45 LSBS
- 46 LSBS
- 47 LSBS
- 48 LSBS
- 49 LSBS
- 50 LSBS
- 51 LSBS
- 52 LSBS
- 53 LSBS
- 54 LSBS
- 55 LSBS
- 56 LSBS
- 57 LSBS
- 58 LSBS
- 59 LSBS
- 60 LSBS
- 61 LSBS
- 62 LSBS
- 63 LSBS
- 64 LSBS
- 65 LSBS
- 66 LSBS
- 67 LSBS
- 68 LSBS
- 69 LSBS
- 70 LSBS
- 71 LSBS
- 72 LSBS
- 73 LSBS
- 74 LSBS
- 75 LSBS
- 76 LSBS
- 77 LSBS
- 78 LSBS
- 79 LSBS
- 80 LSBS
- 81 LSBS
- 82 LSBS
- 83 LSBS
- 84 LSBS
- 85 LSBS
- 86 LSBS
- 87 LSBS
- 88 LSBS
- 89 LSBS
- 90 LSBS
- 91 LSBS
- 92 LSBS
- 93 LSBS
- 94 LSBS
- 95 LSBS
- 96 LSBS
- 97 LSBS
- 98 LSBS
- 99 LSBS
- 100 LSBS

AVR UNIT

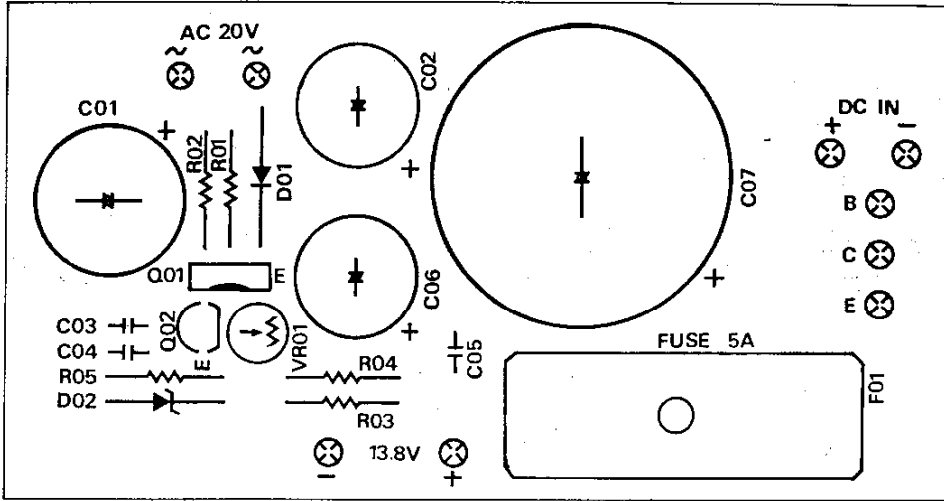

Viewed from component side

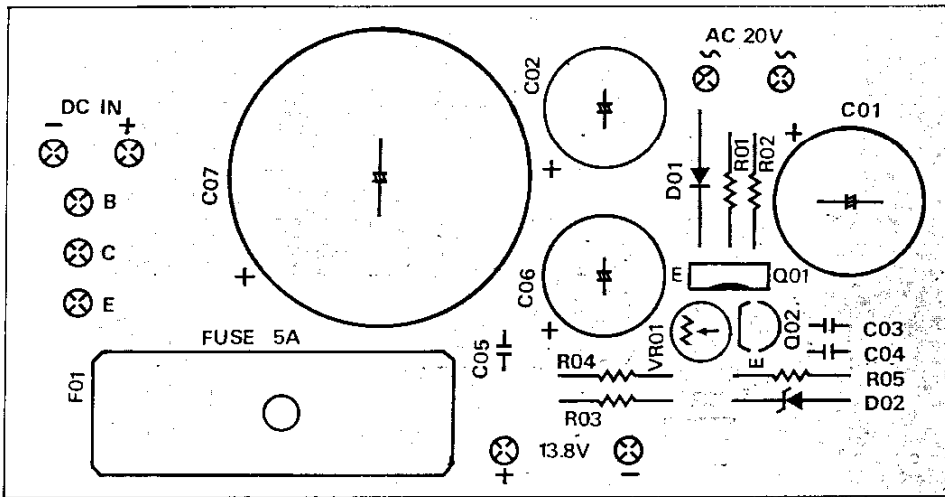
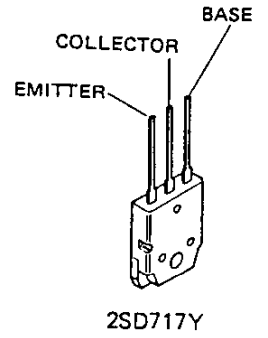

Viewed from solder side

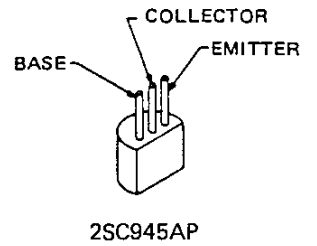
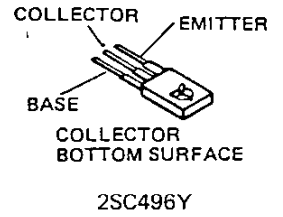

FOR SERVICE MANUALS
CONTACT:

MAURITRON TECHNICAL SERVICES

www.mauritron.co.uk

TEL: 01844 - 351694

FAX: 01844 - 352554

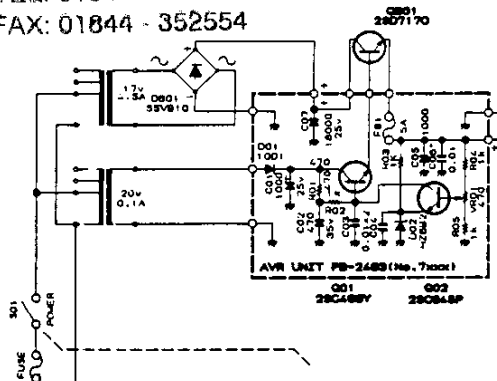

10W PS UNIT VOLTAGE CHART (DC VOLTS)

	E(S)	C(D)	B(G1)	REMARKS
Q601	13.7	20.5	14.4	

AVR UNIT VOLTAGE CHART (DC VOLTS)

	E(S)	C(D)	B(G1)	REMARKS
Q701	14.4	24.0	15.0	
Q702	5.8	15.0	6.5	

DISPLAY UNIT

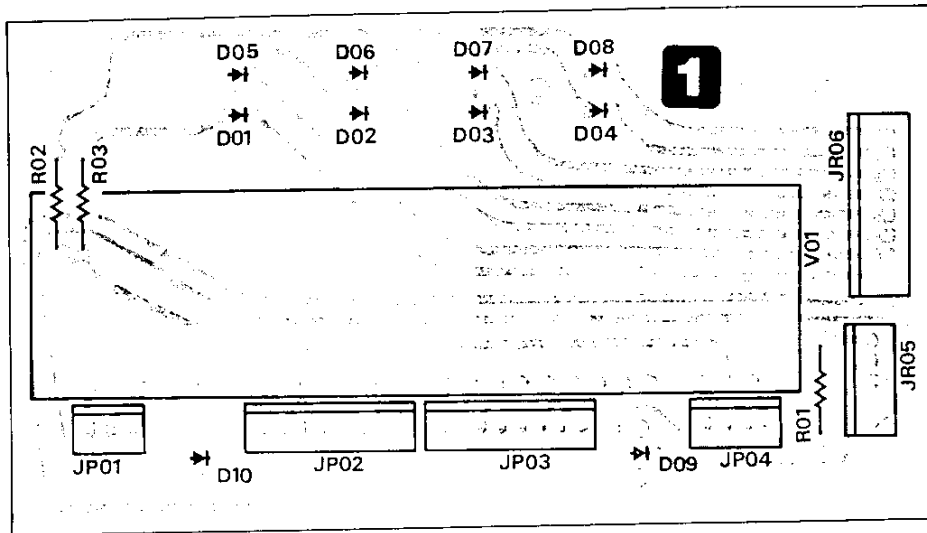

Viewed from component side

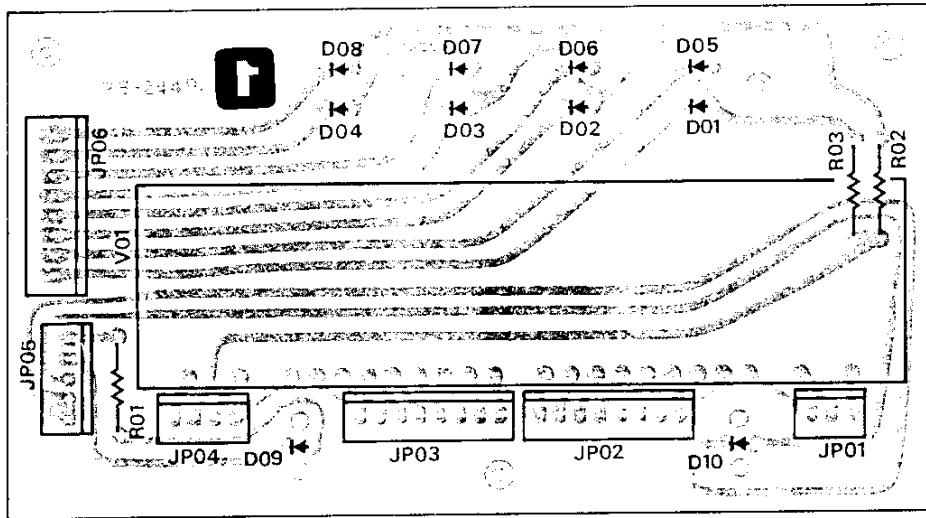

Viewed from solder side

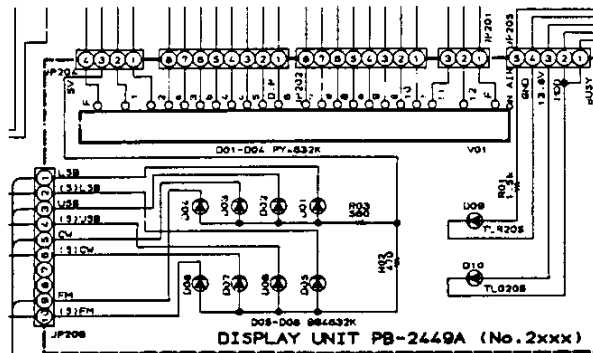

SCAN/SQL SW UNIT

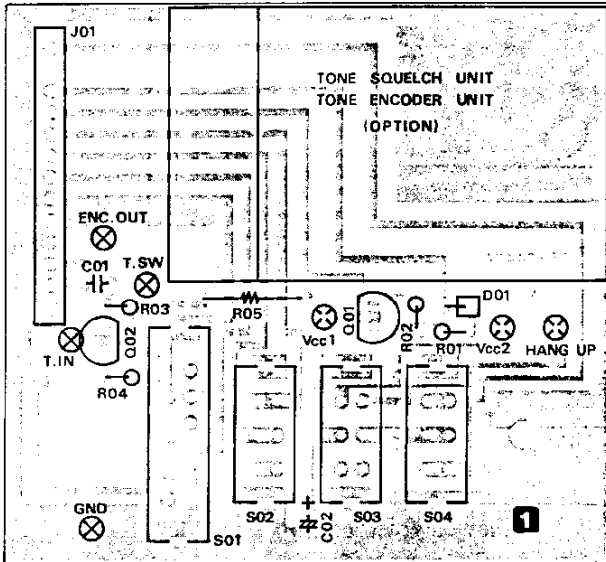

Viewed from component side

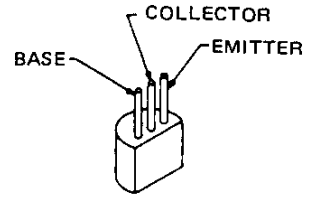

2SA733AP
2SC945AP

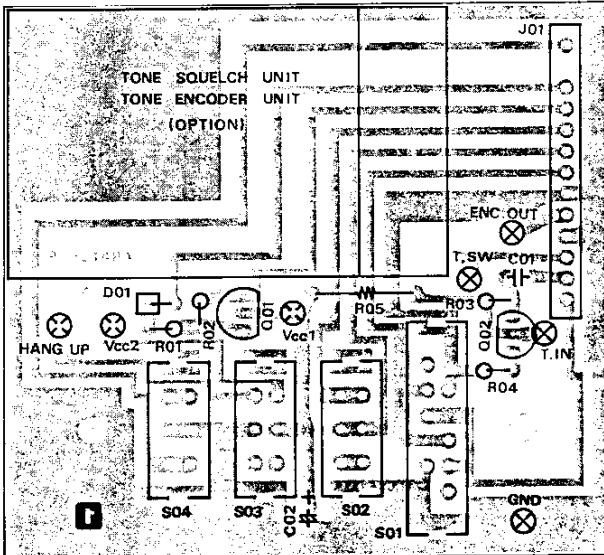

Viewed from solder side

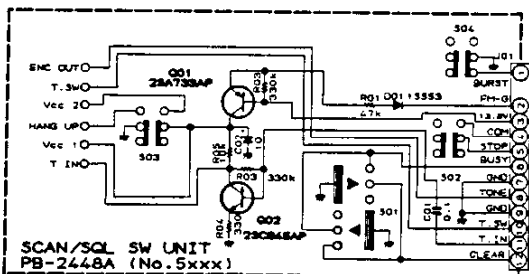

FOR SERVICE MANUALS
CONTACT:
MAURITRON TECHNICAL SERVICES
www.mauritron.co.uk
TEL: 01844 - 351694
FAX: 01844 - 352554

SW UNITS A-H

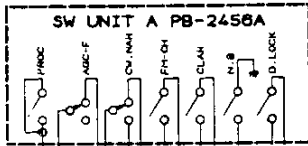
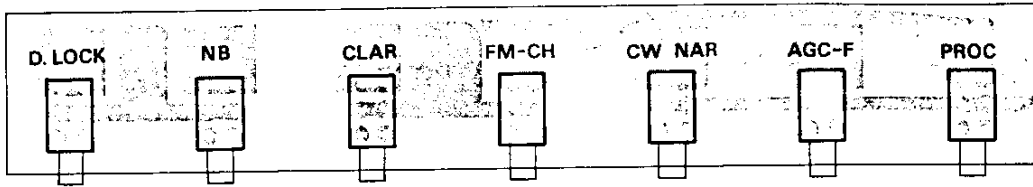

All views from solder side

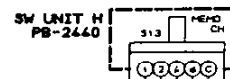
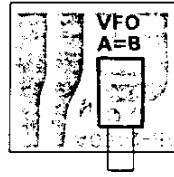
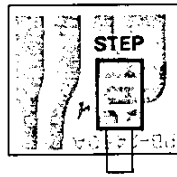
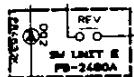
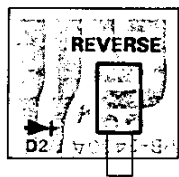
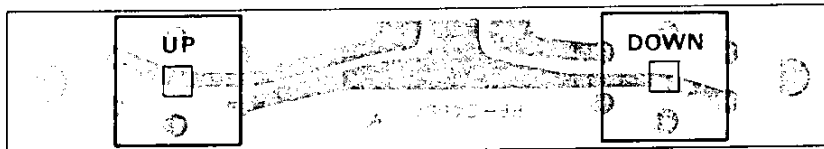
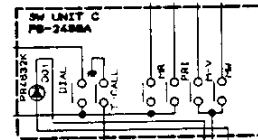
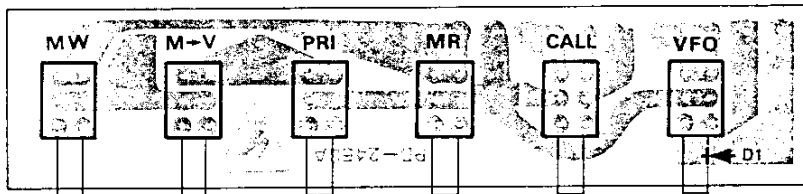
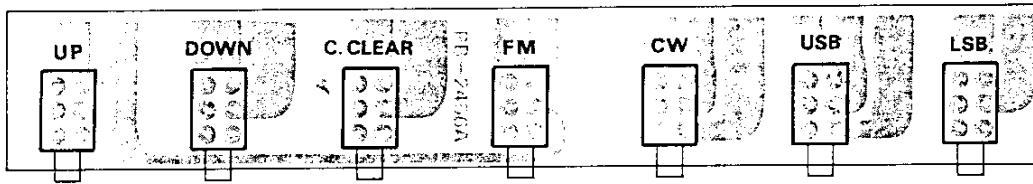
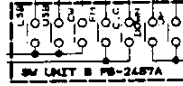

FTS-32R AND FTE-36 TONE SQL UNITS

FTS-32R

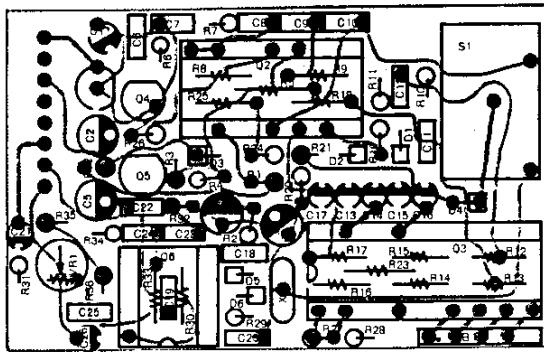

Viewed from component side

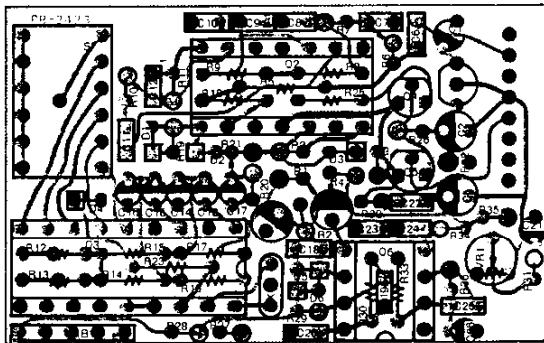

Viewed from solder side

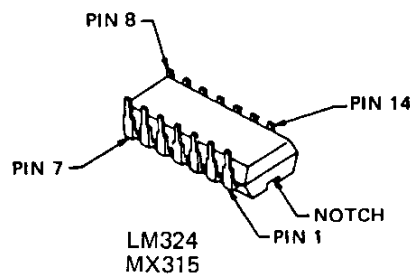
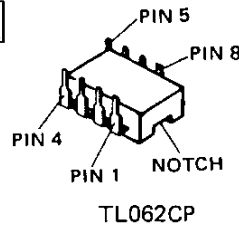
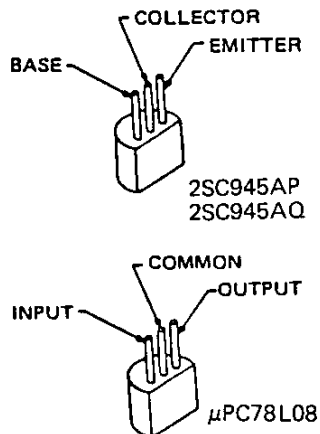
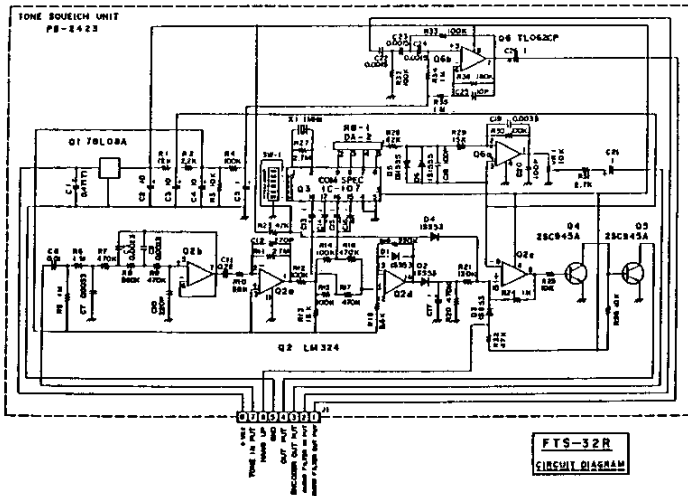

FTE-36

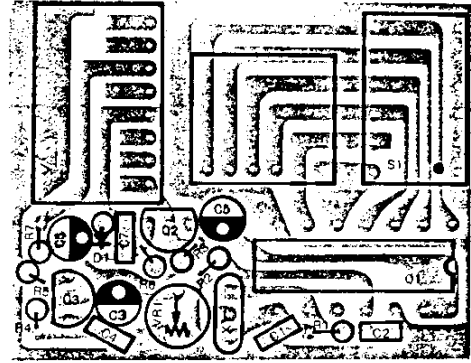

Viewed from component side

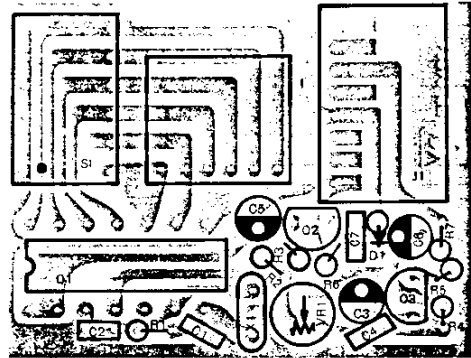

Viewed from solder side

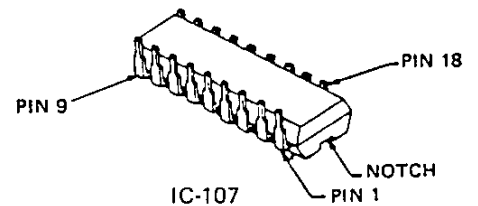
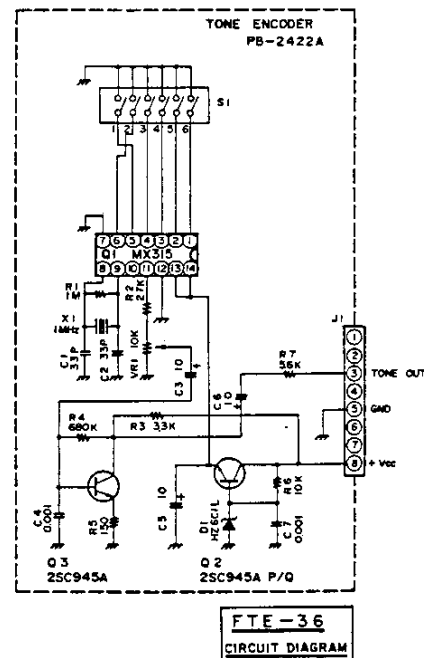

CONTROL UNIT F

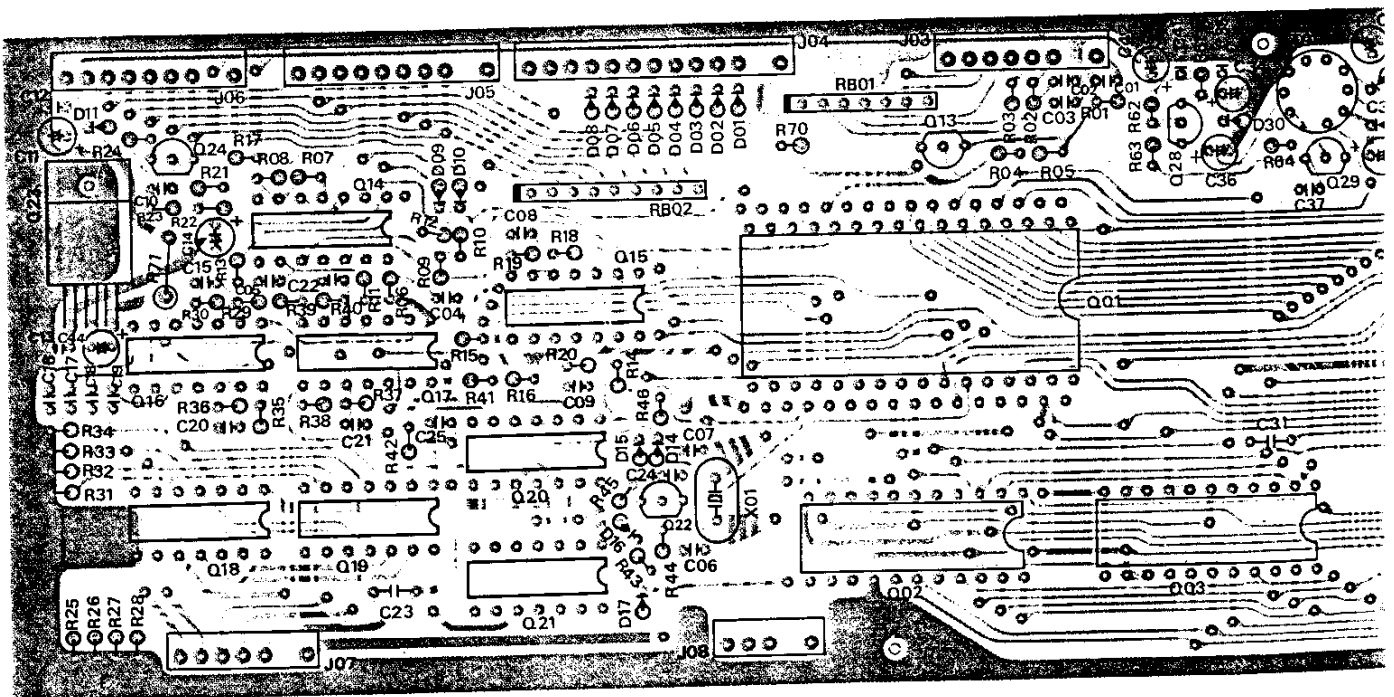
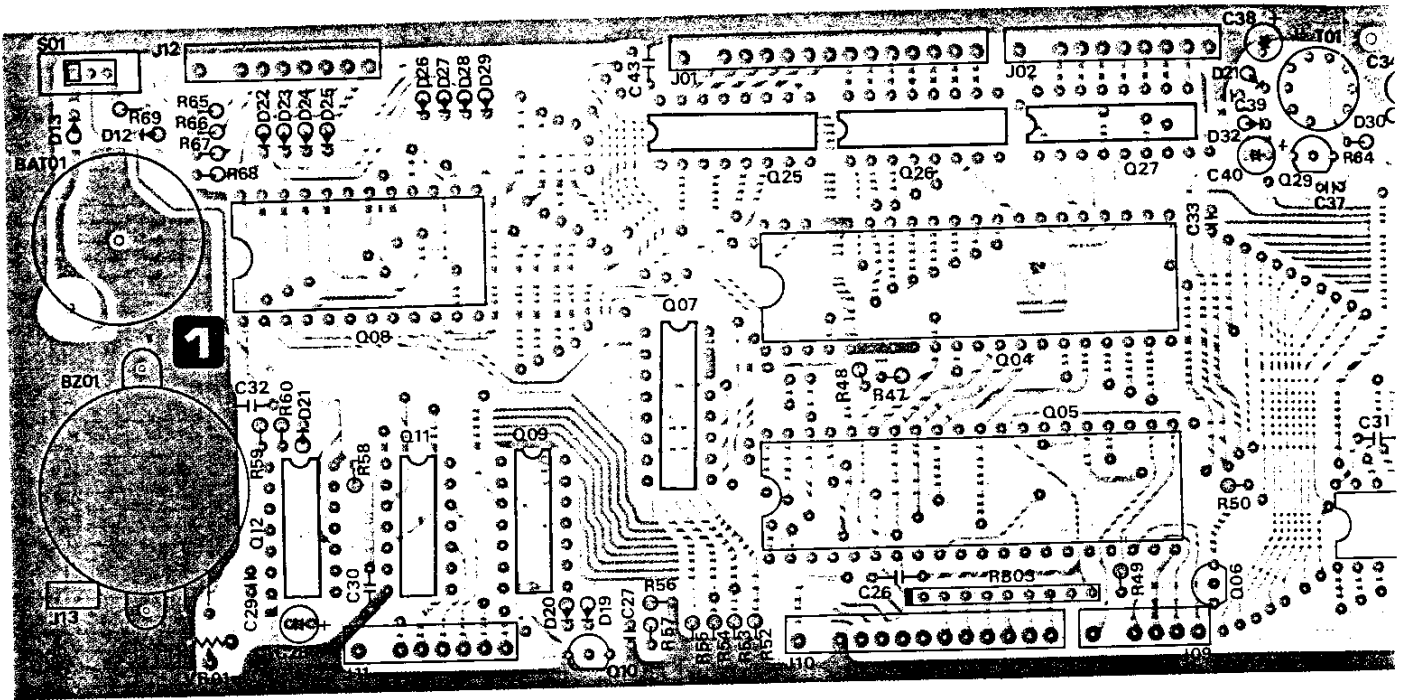

FOR SERVICE MANUALS
CONTACT:
MAURITRON TECHNICAL SERVICES
www.mauritron.co.uk
TEL: 01844 - 351694
FAX: 01844 - 352554

CONTROL UNIT PARTS LAYOUT

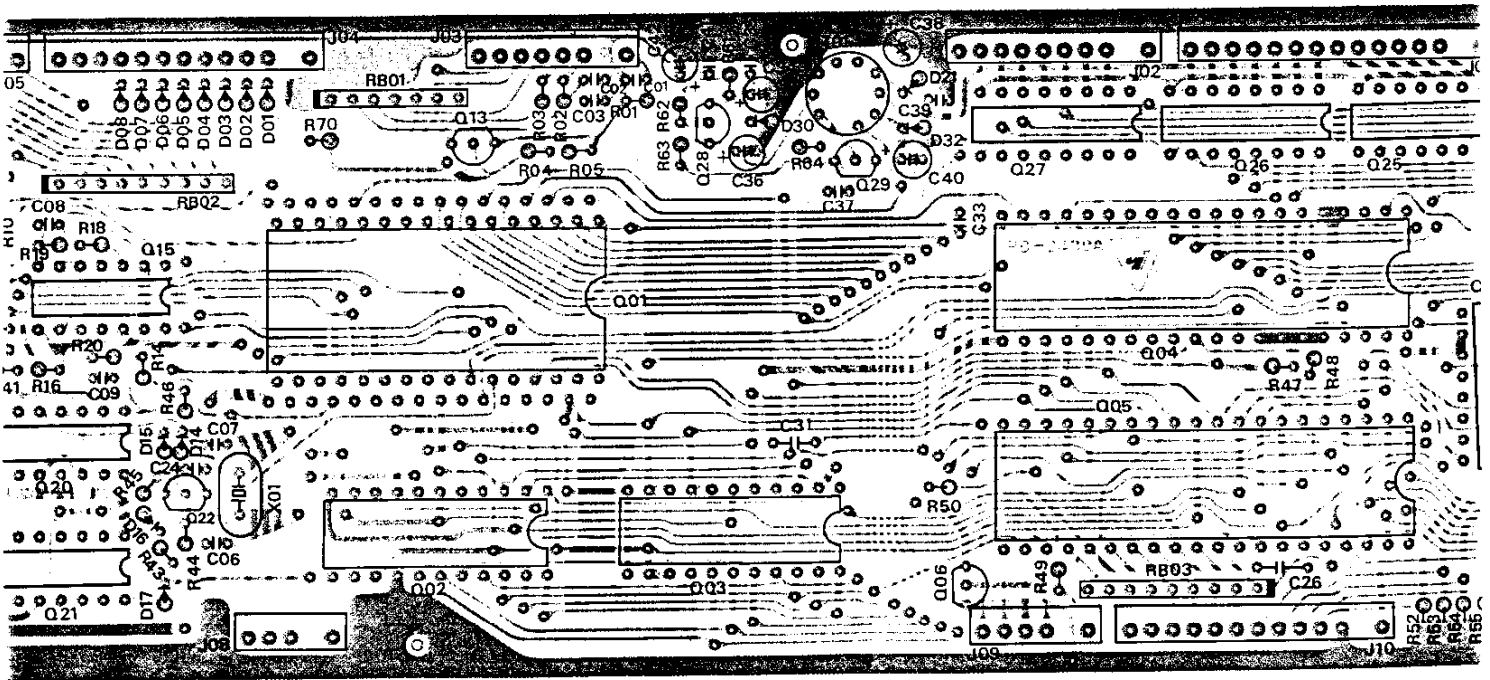
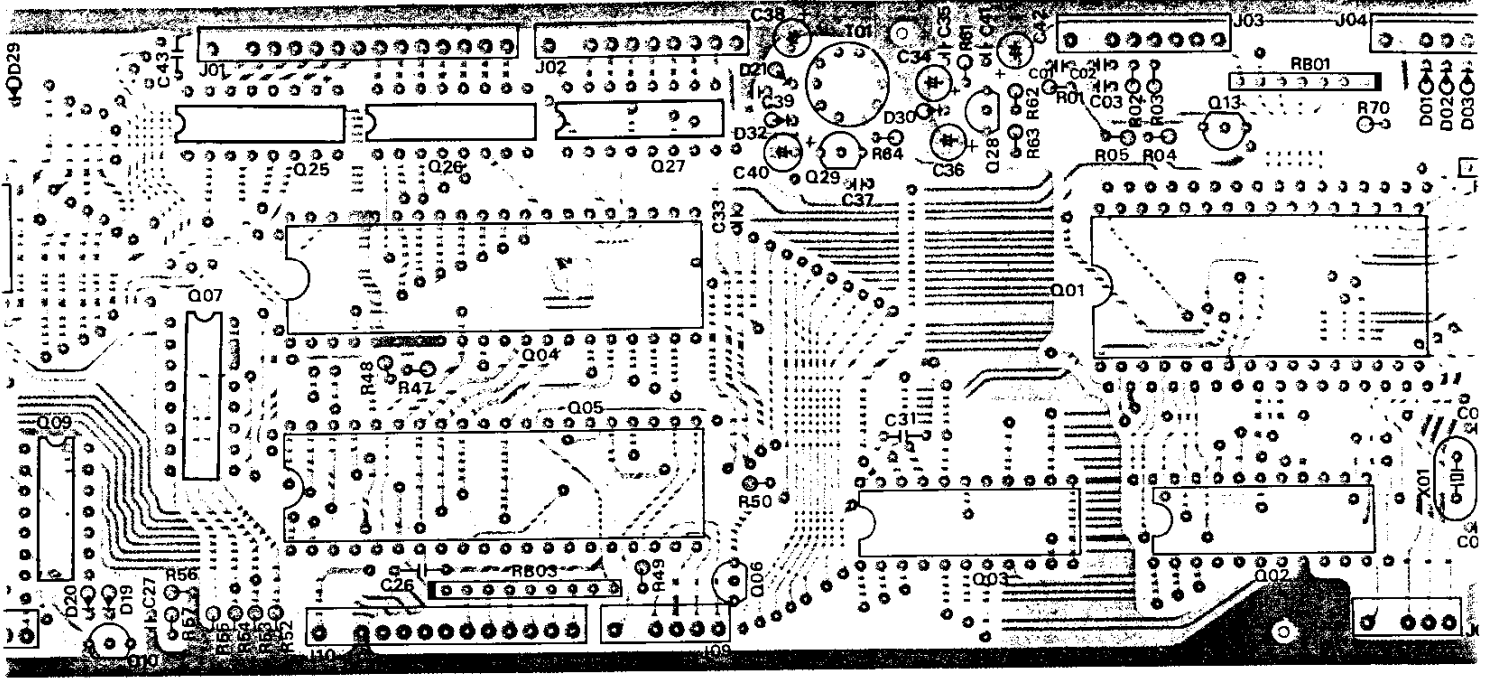

ROL UNIT PARTS LAYOUT

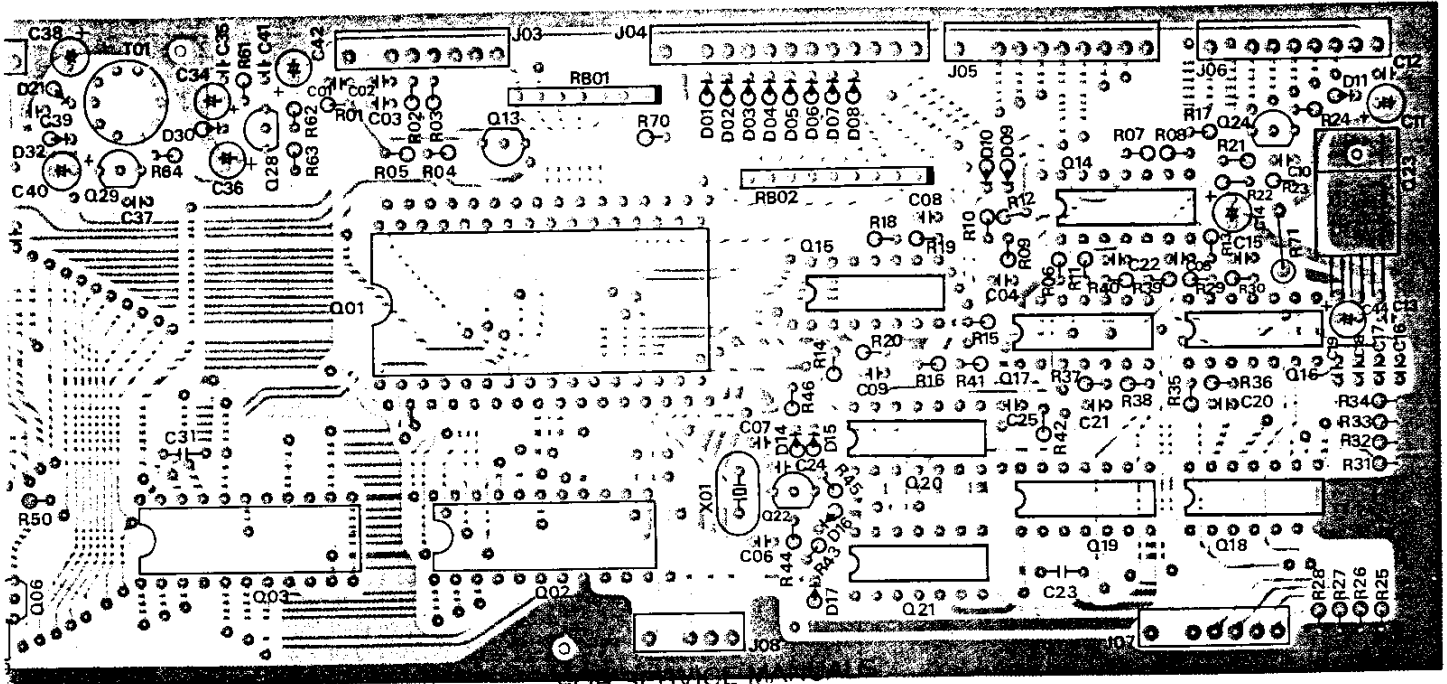

FOR SERVICE CONTACT:
MAURITRON TECHNICAL SERVICES
www.mauritron.co.uk
 TEL: 01844 - 351694
 FAX: 01844 - 352554

Viewed from component side

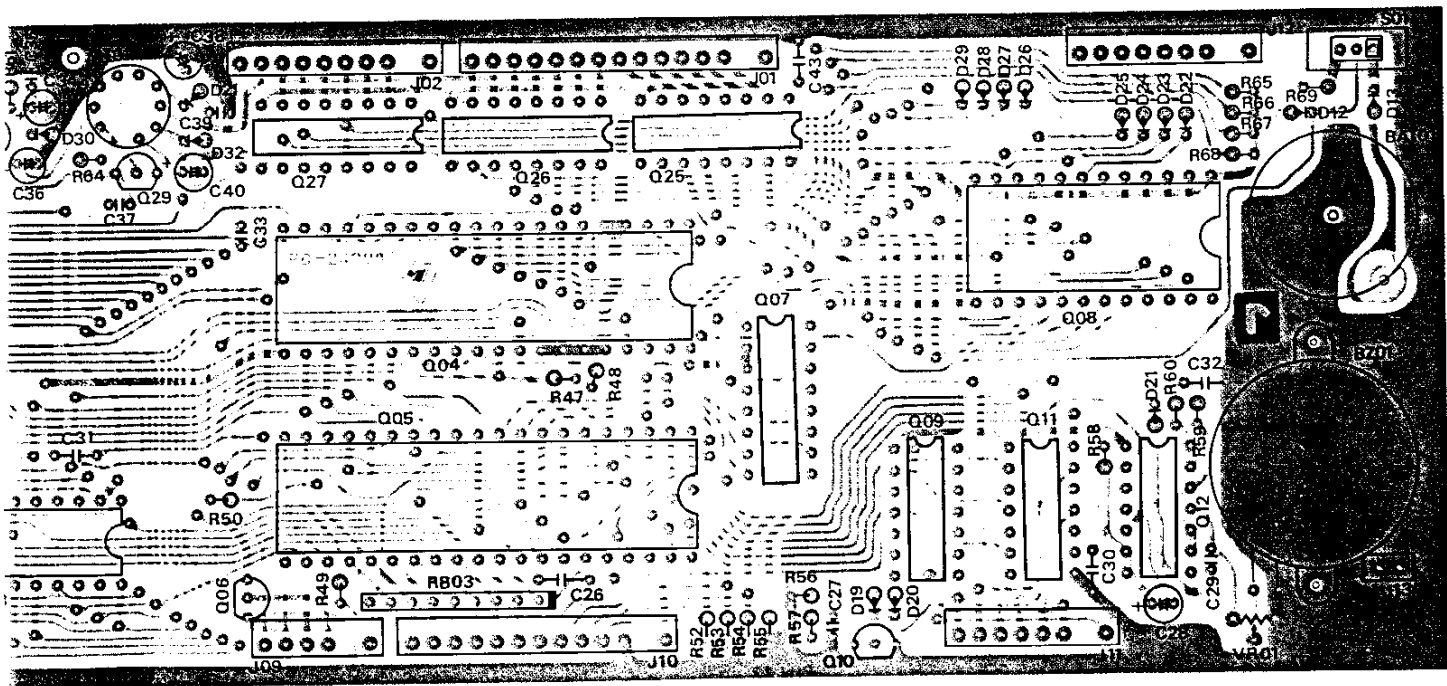

Viewed from solder side

CONTROL UNIT SC

CNTL UNIT VOLTAGE CHART (DC VOLTS)

	E(S)	C(D)	B(G1)	REMARKS
Q3006	0	3.4	0	
Q3010	0	7.6	0	
Q3013	0	0	0.6	
Q3022	0	0	0.7	
Q3024	0	0	0.6	
Q3028	9.9	13.5	10.6	
Q3029	0	9.9	0	

	1	2	3
Q3023	13.8	0	5.0

FOR SERVICE MANUALS
CONTACT:
MAURITRON TECHNICAL SERVICES
www.mauritron.co.uk
TEL: 01844 351694
FAX: 01844 352554

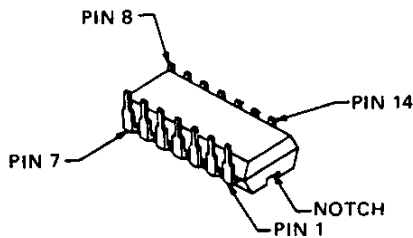
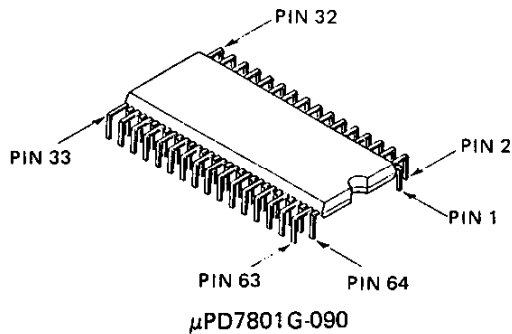
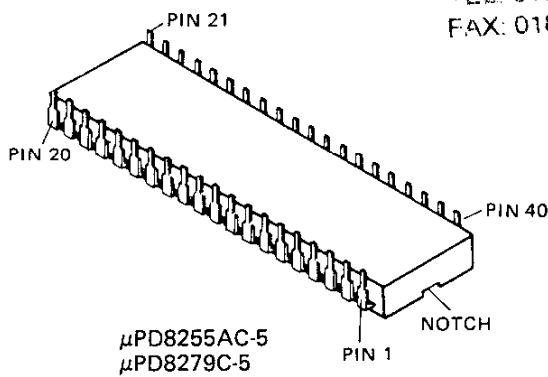

- MC14001B MC14072B
- MC14011B MC14081B
- MC14013B SN7416N
- MC14069UB μPA80C

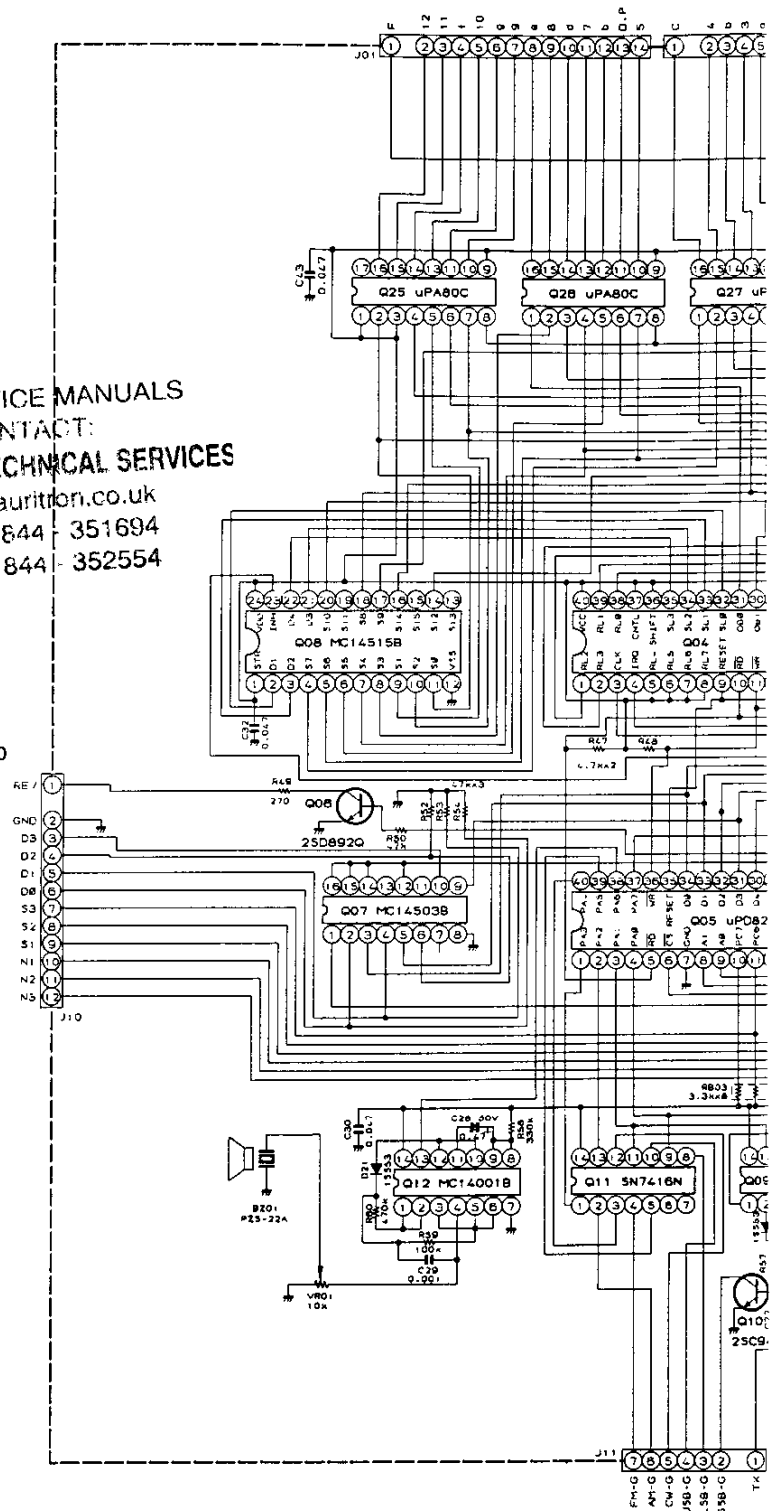
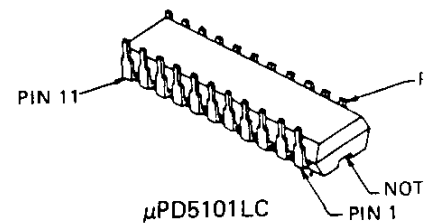
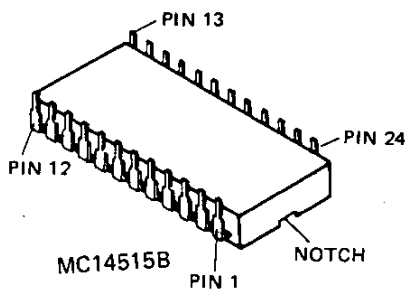

SCHEMATIC DIAGRAM

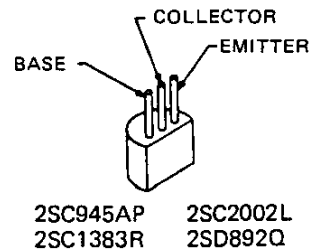
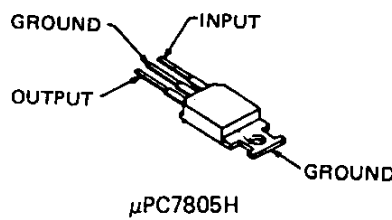
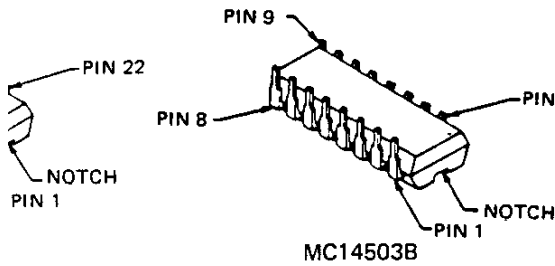
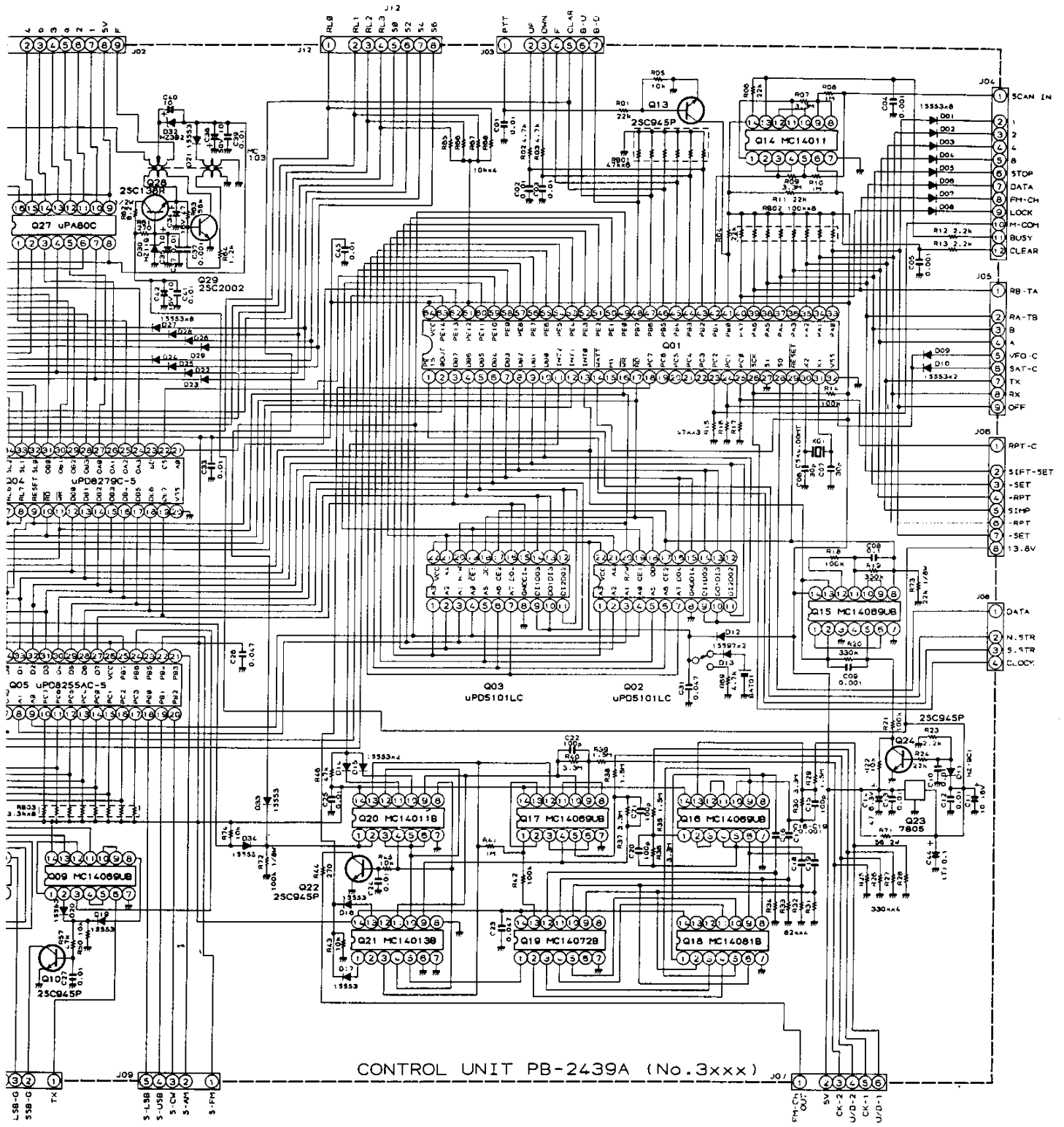

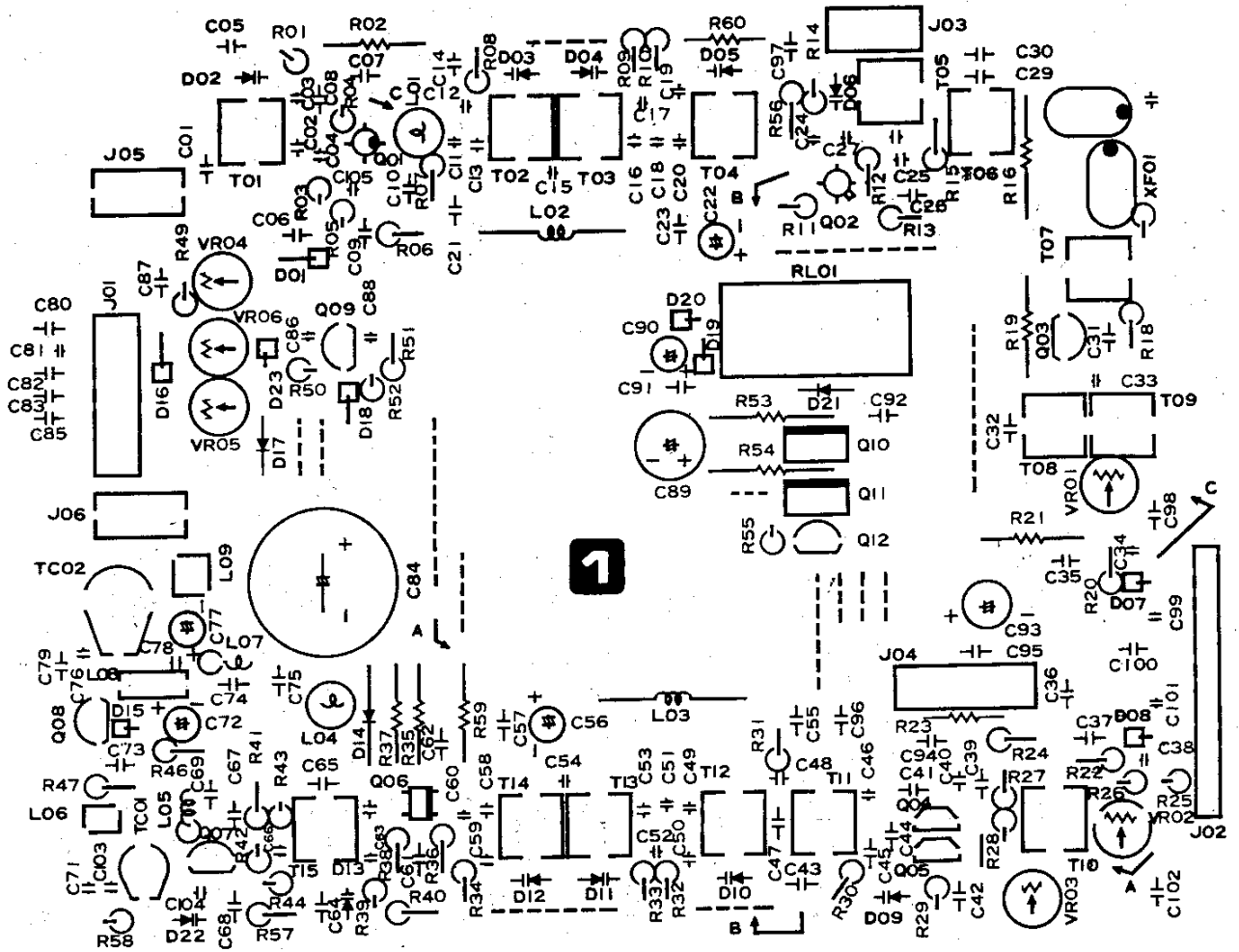

Viewed from component side

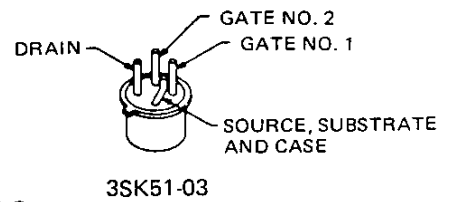
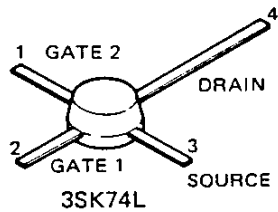

FOR SERVICE MANUALS
CONTACT:
MAURITRON TECHNICAL SERVICES

www.mauritron.co.uk
TEL: 01844 - 351694
FAX: 01844 - 352554

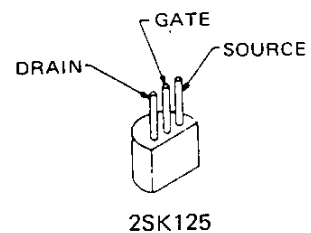
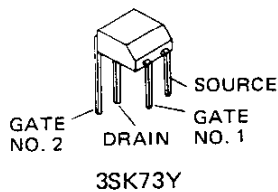

50 MHz MODULE: RF UNIT PARTS L

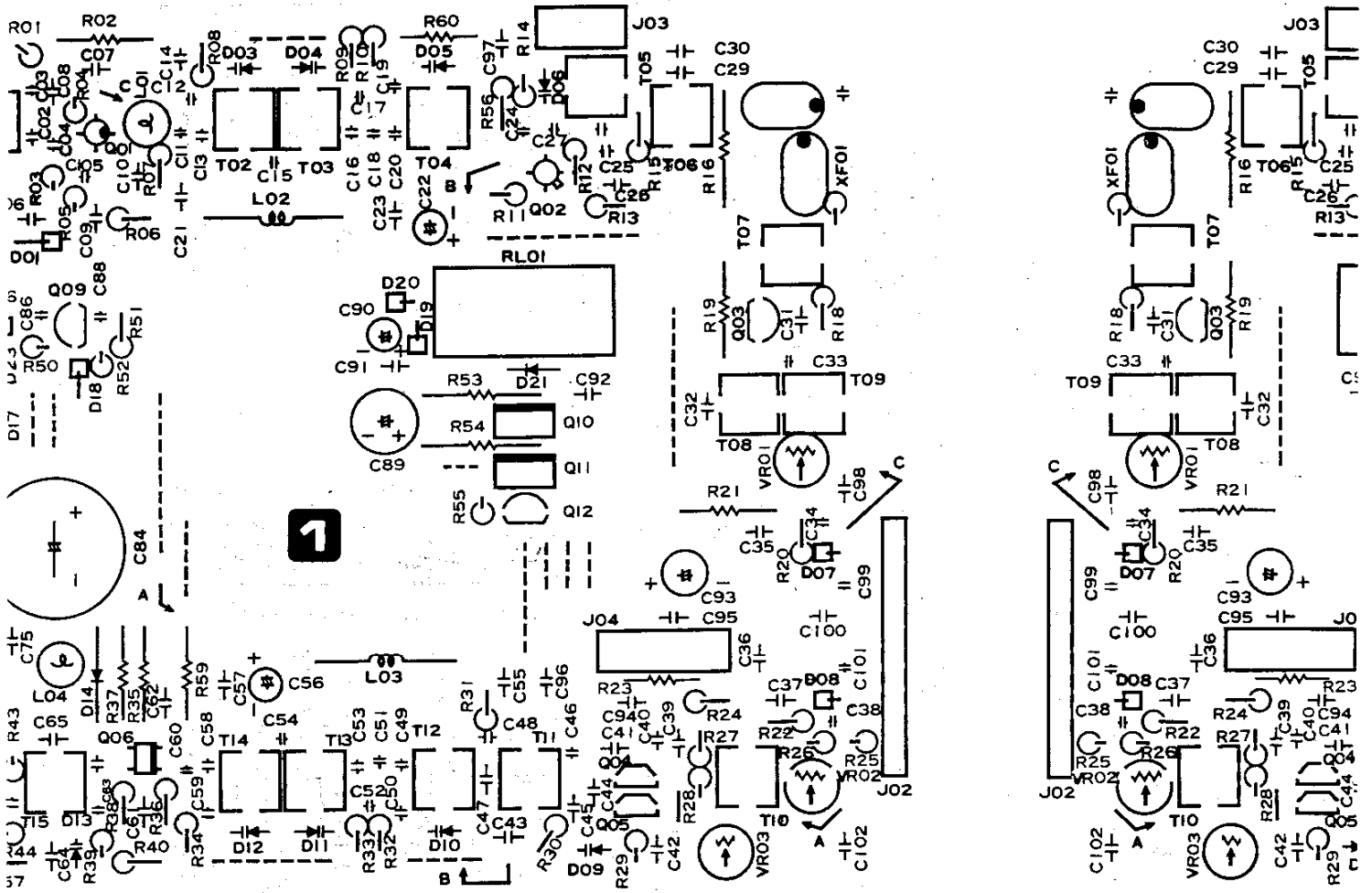

Viewed from component side

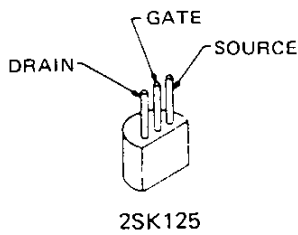
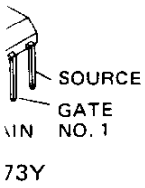
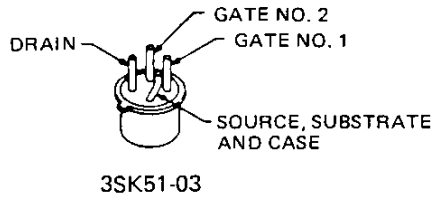
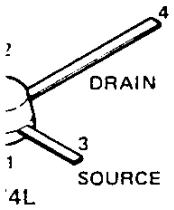

SOL

GATE

EMITTER

MODULE: RF UNIT PARTS LAYOUT

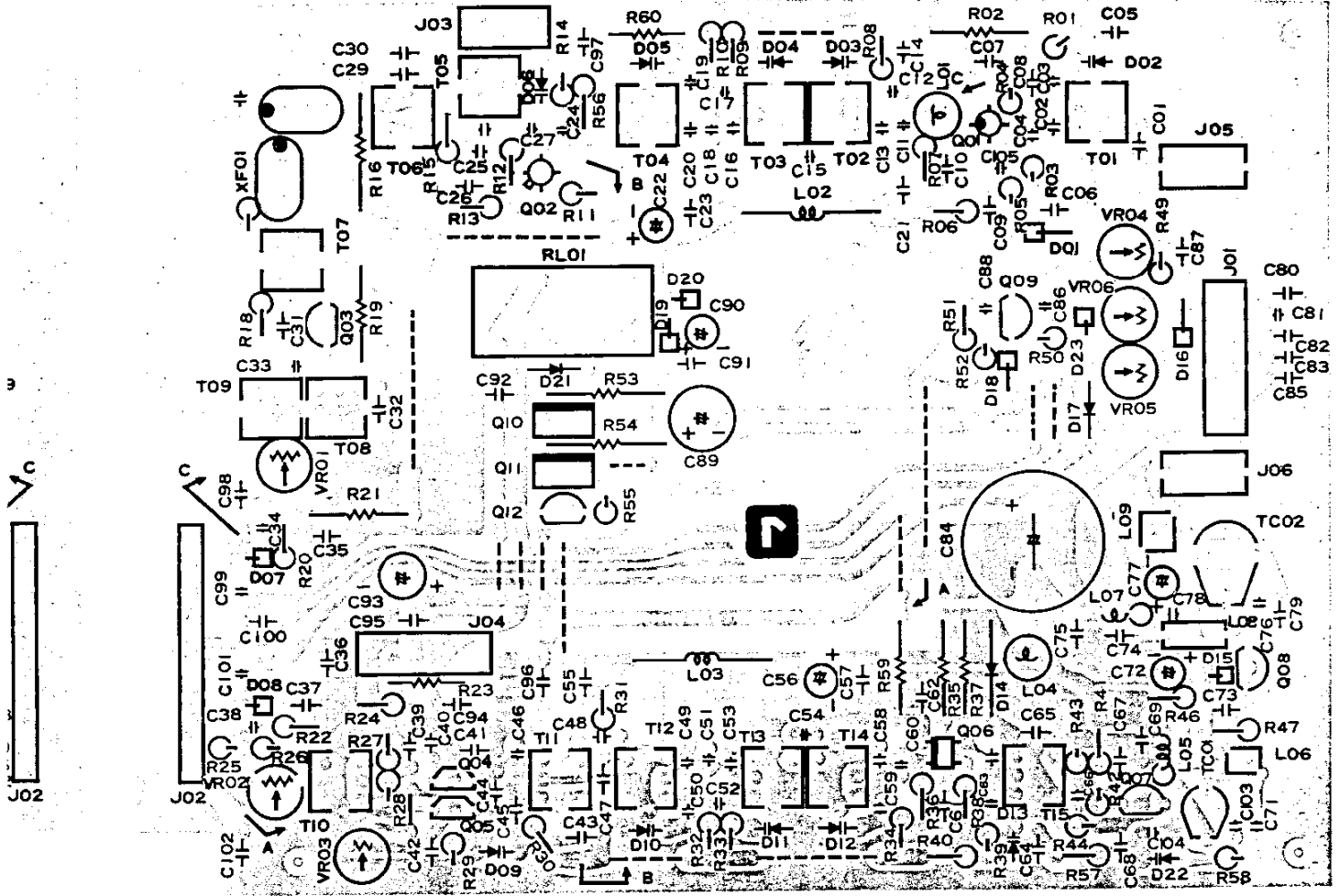

nt side

Viewed from solder side

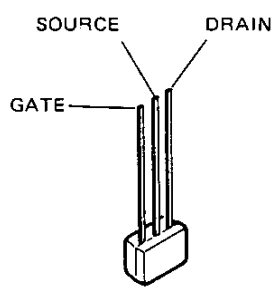

2SK241

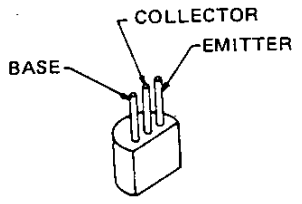

2SA733AQ
2SC460B

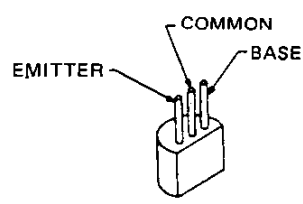

2SC2053

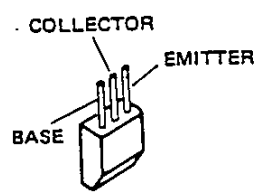

2SD471L

FOR SERVICE MANUALS
CONTACT:
MAURITRON TECHNICAL SERVICES

www.mauritron.co.uk
TEL: 01844 - 351694
FAX: 01844 - 352554

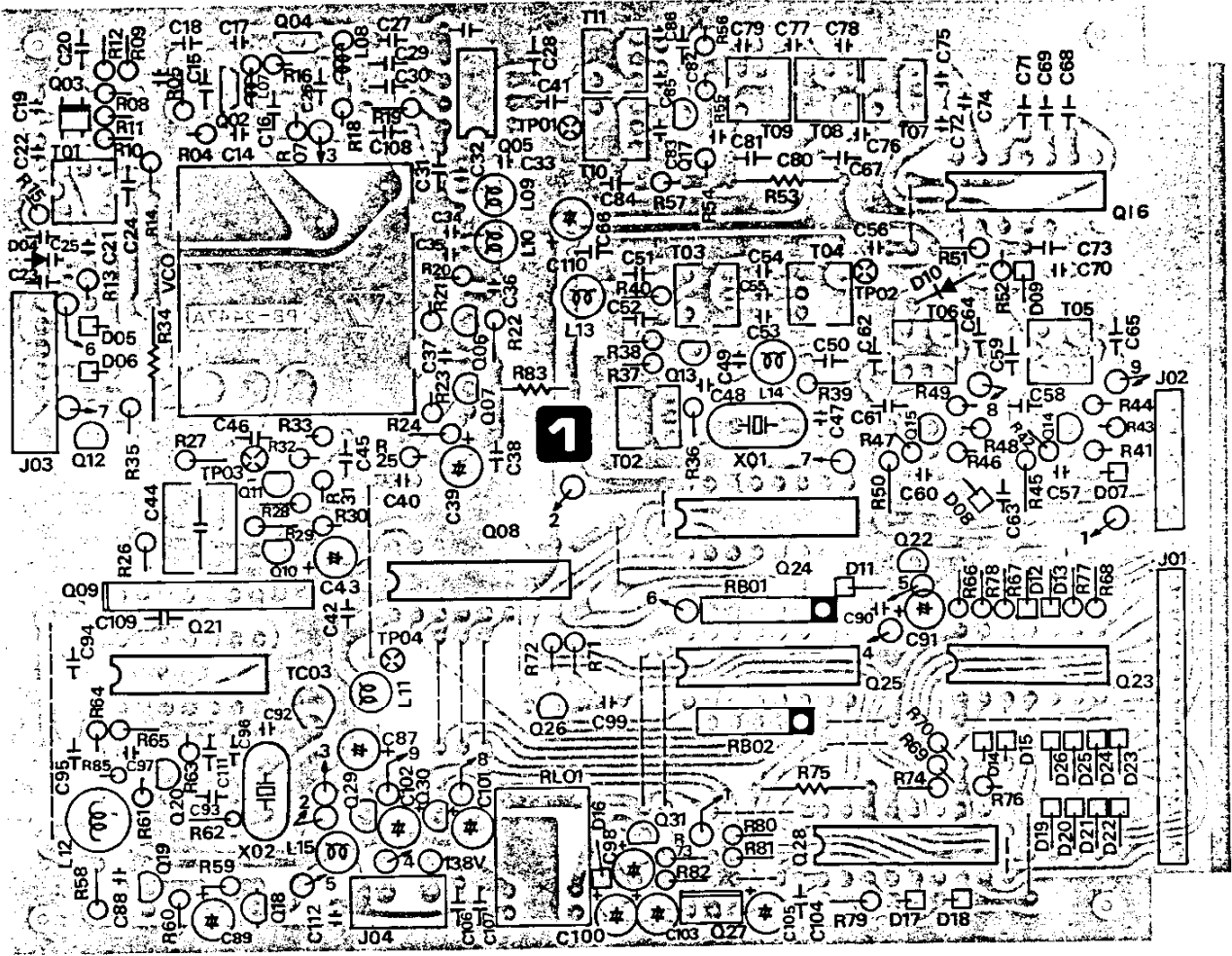

Viewed from component side

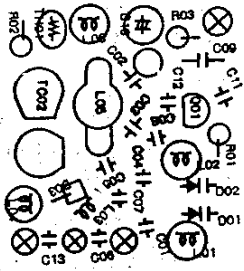

VCO UNIT

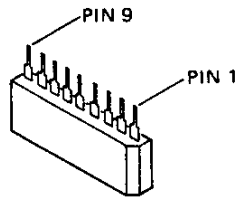

TC5081AP

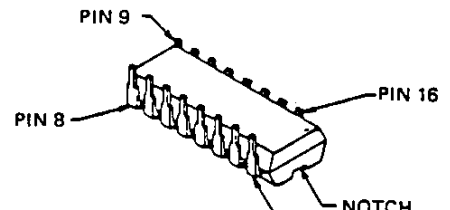

MC14094B
MC14504B
MC14560B

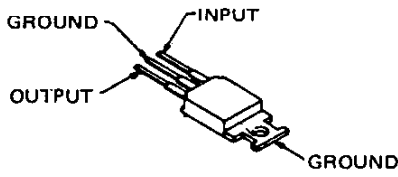

μPC7808H

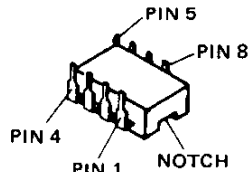

SN16913P

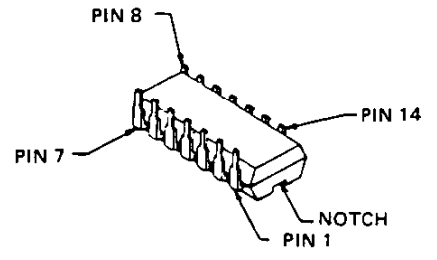

MC14081B
MB84024B
SN76514N

50 MHz MODULE: PLL UNIT PARTS LAYOUT

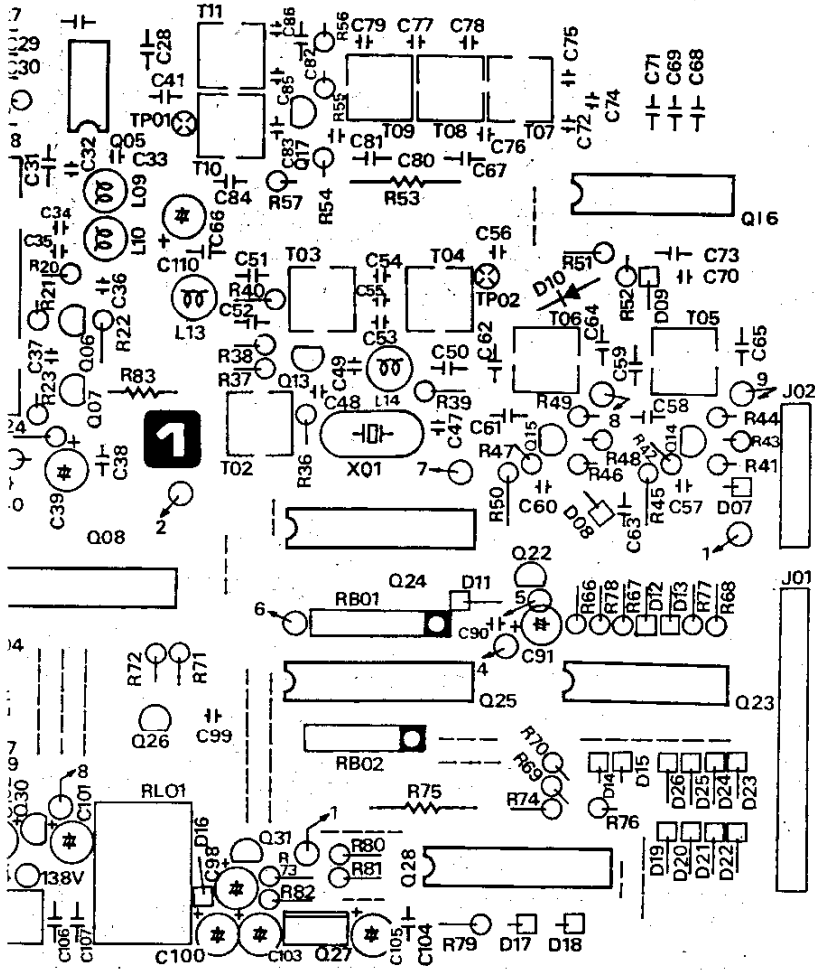

Viewed from component side

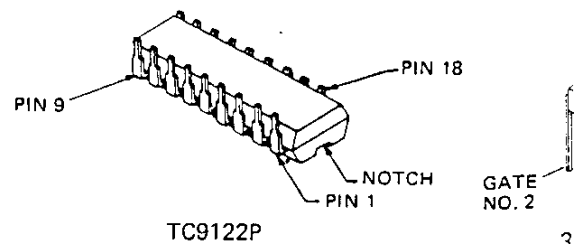
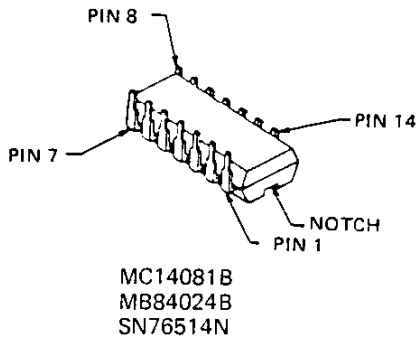
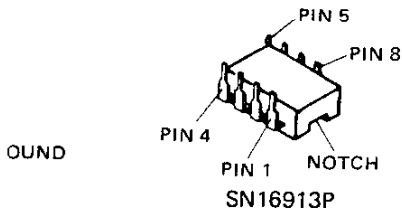
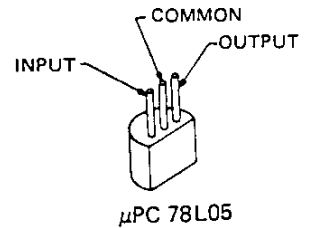
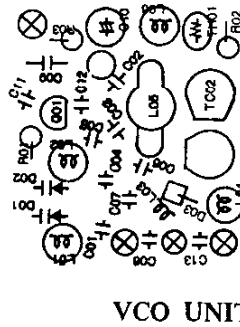
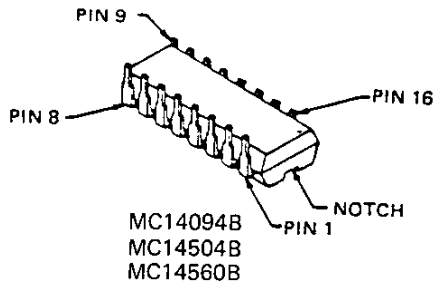
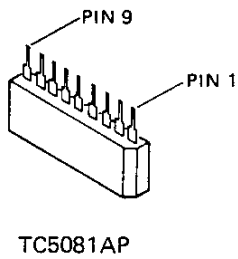
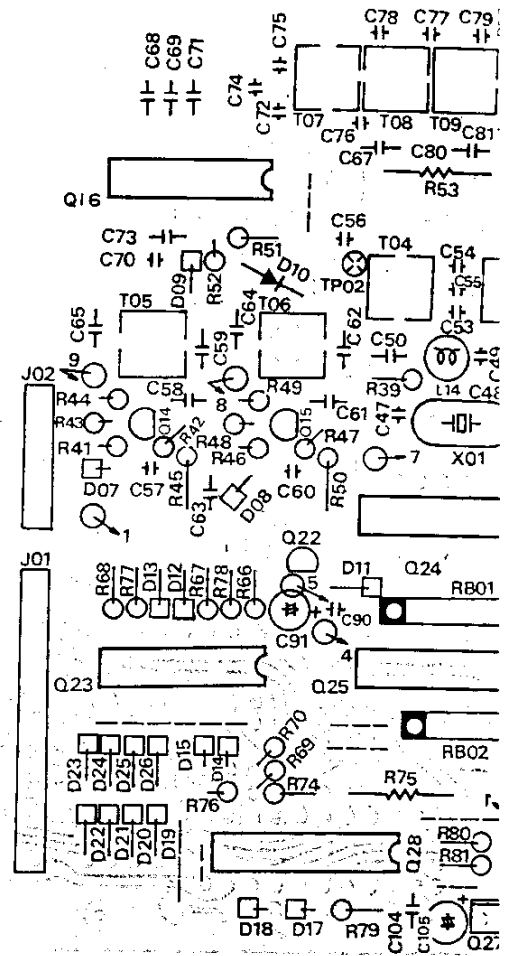

E: PLL UNIT PARTS LAYOUT

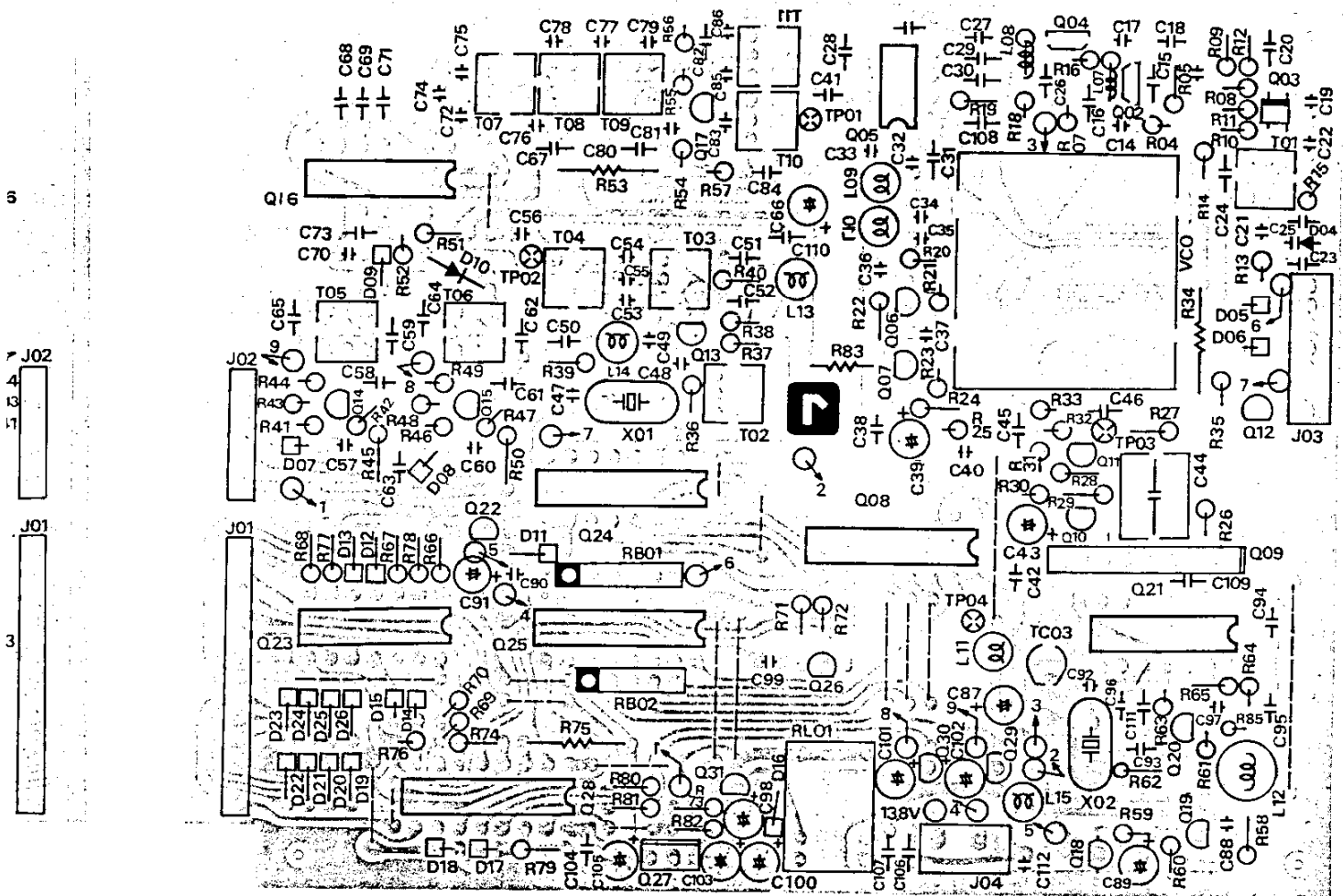

ent side Viewed from solder side

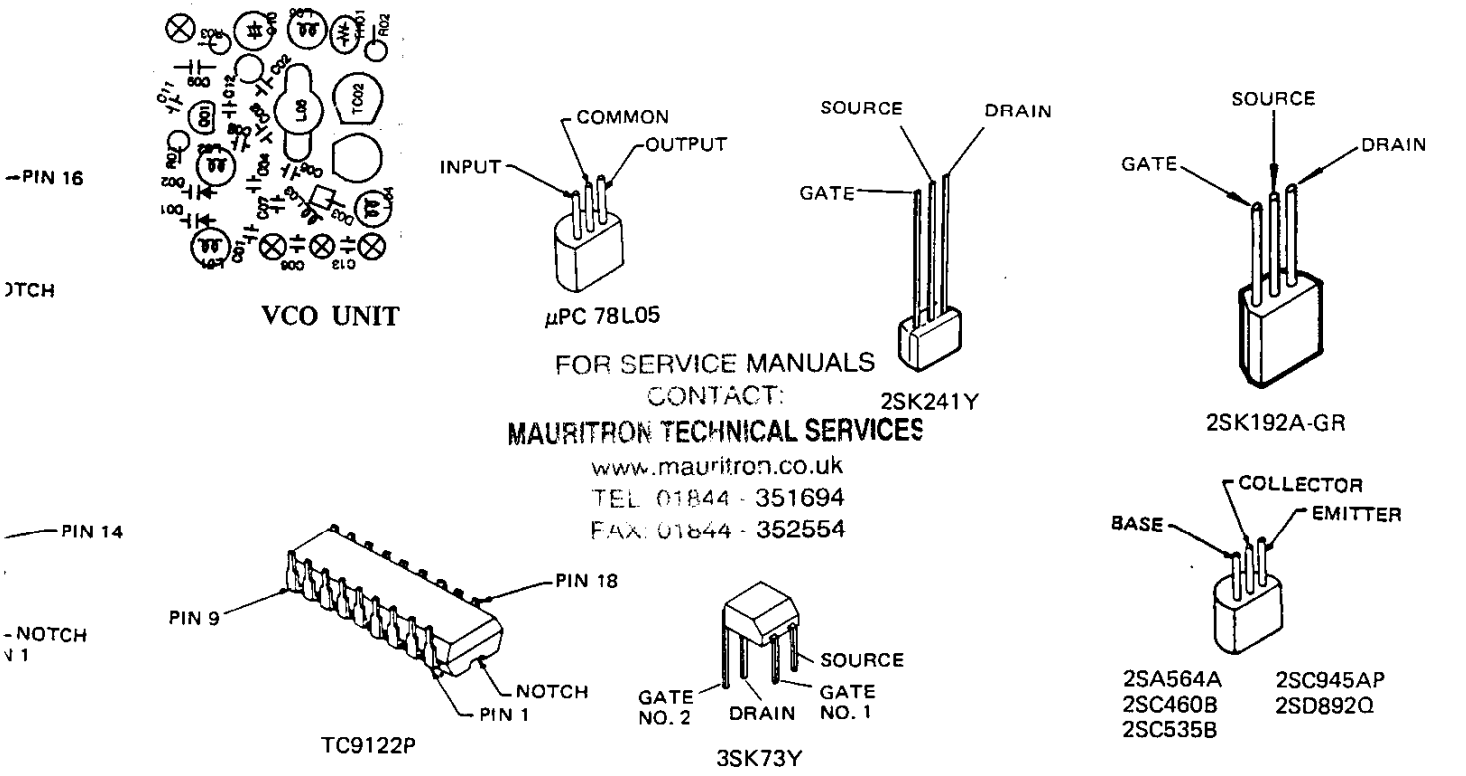

FOR SERVICE MANUALS CONTACT:
MAURITRON TECHNICAL SERVICES

www.mauritron.co.uk
 TEL 01844 - 351694
 FAX: 01844 - 352554

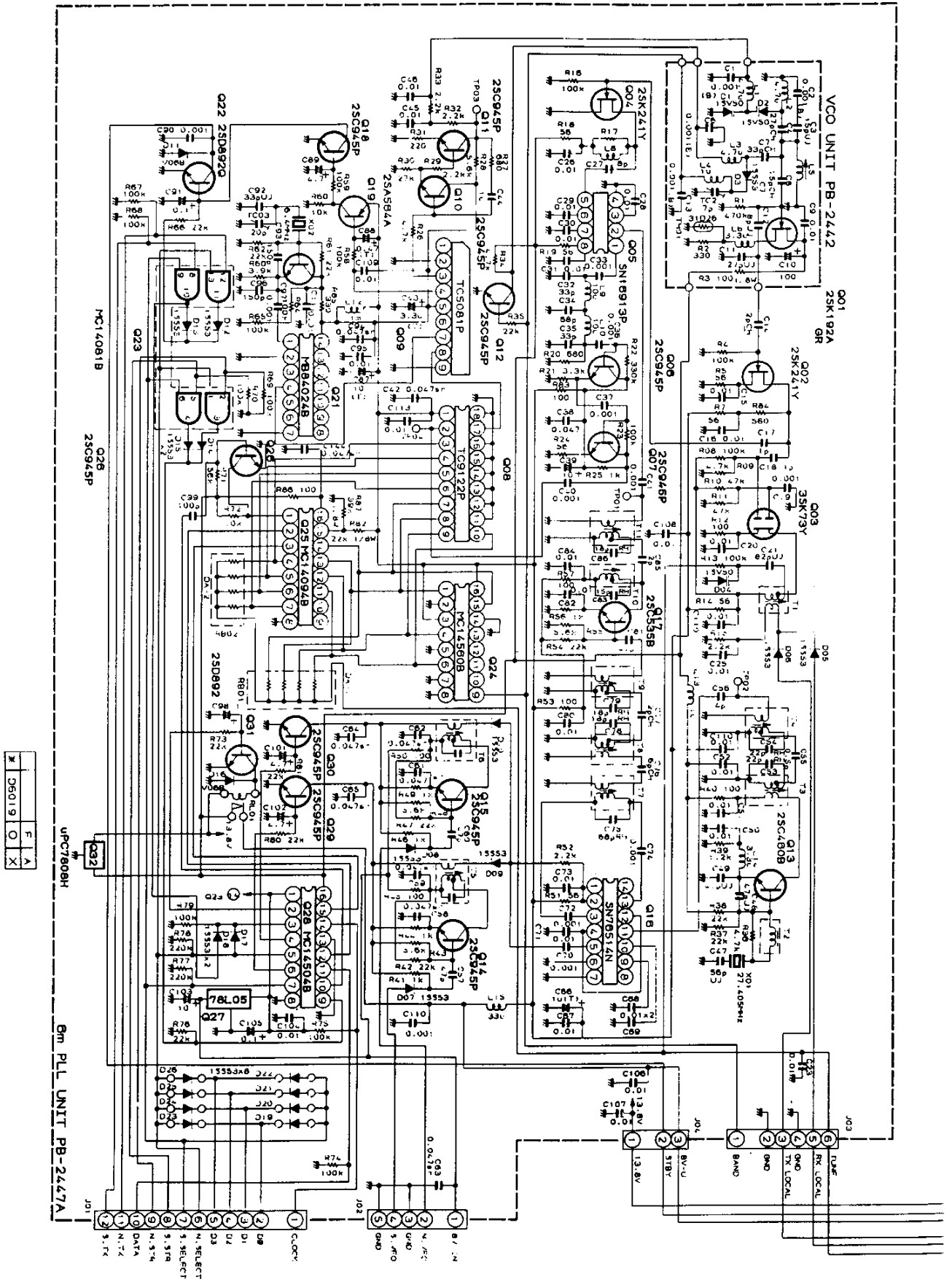

W	56019	O	X
		F	A

50 MHz MODULE SCHEMATIC DIAGRAM

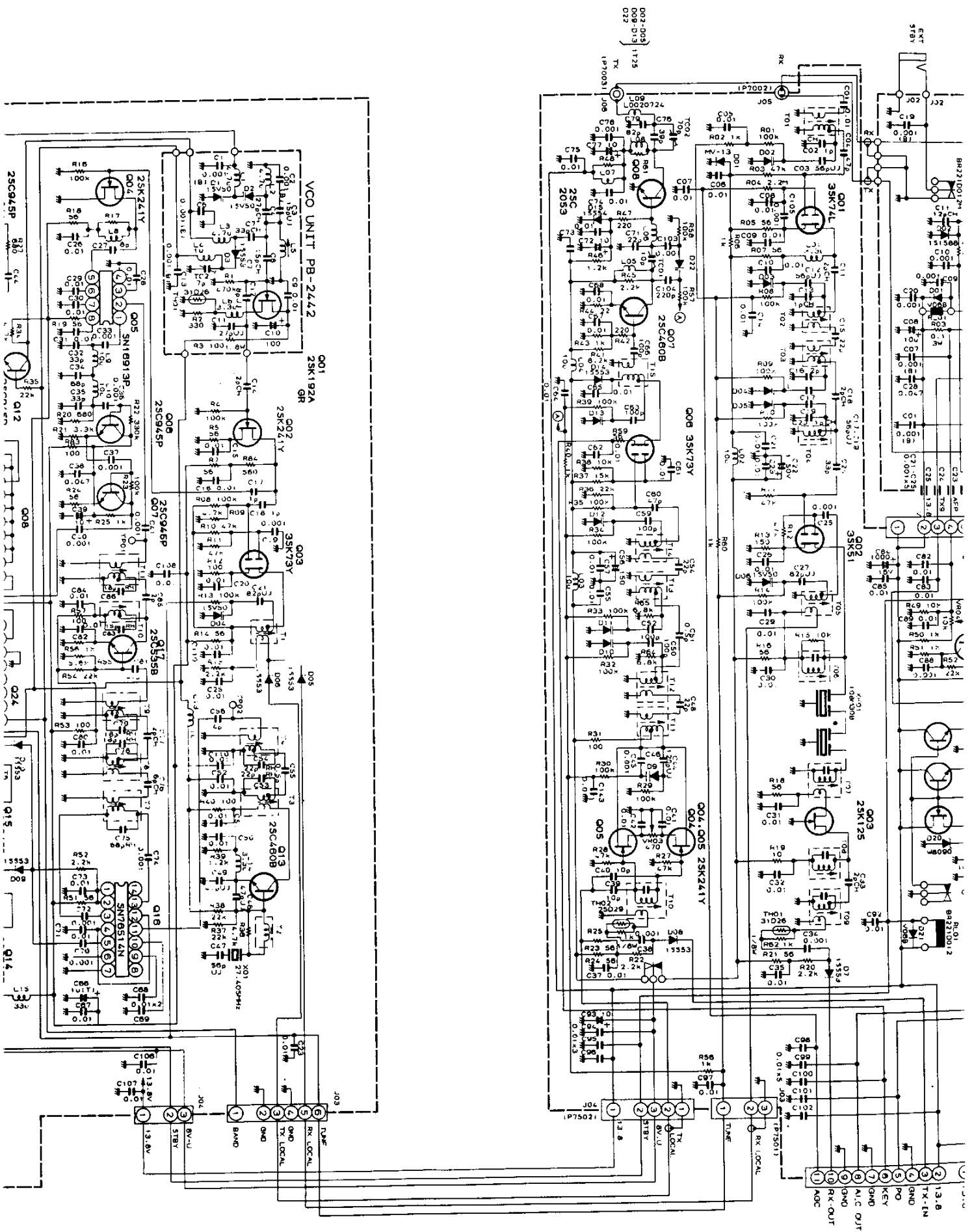

SCHEMATIC DIAGRAM

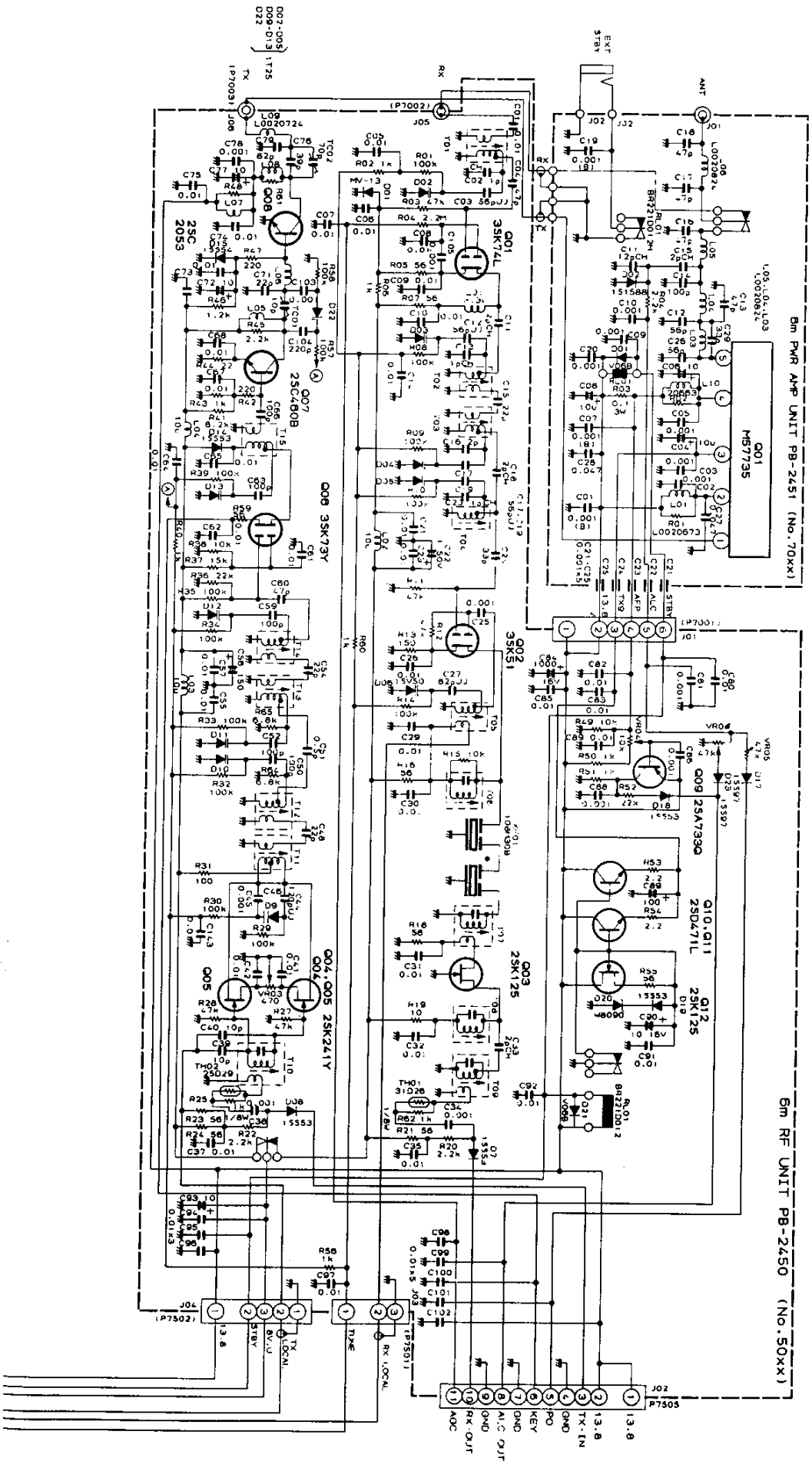

FOR SERVICE MANUALS
 CONTACT:
MAURITRON TECHNICAL SERVICES
 www.mauritron.co.uk
 TEL: 01844 - 351694
 FAX: 01844 - 352554

50 MHz MODULE: PA UNIT P

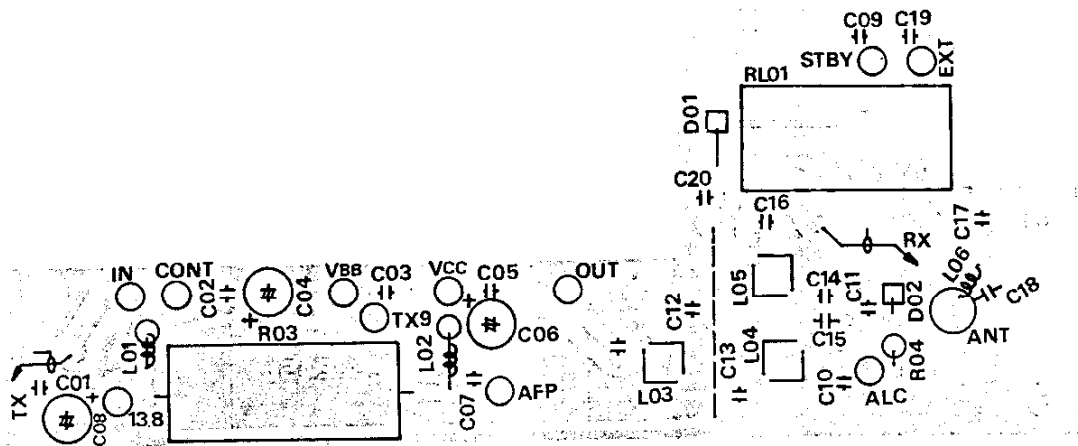

Viewed from component side

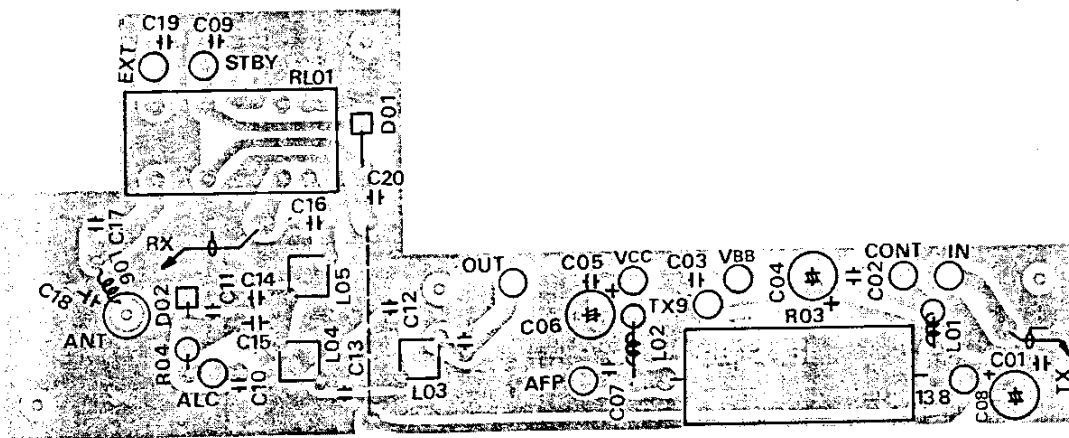

Viewed from solder side

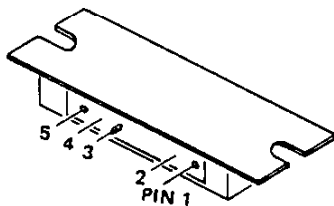

M57735

FOR SERVICE MANUALS
CONTACT:
MAURITRON TECHNICAL SERVICES

www.mauritron.co.uk
TEL: 01844 - 351694
FAX: 01844 - 352554

50 MHz I

Q5001	1
Q5002	0
Q5004	
Q5003	1
Q5005	
Q5006	
Q5007	
Q5008	
Q5009	
Q5010	
Q5011	
Q5012	
Q6001	C
Q6002	C
Q6003	C
Q6004	
Q6006	4
Q6007	C
Q6010	C
Q6011	C
Q6012	
Q6013	
Q6014	
Q6015	
Q6017	C
Q6018	
Q6019	
Q6020	
Q6022	
Q6026	
Q6029	
Q6030	
Q6031	

Q6005	
Q6008	
Q6009	
Q6016	
Q6021	
Q6023	
Q6024	
Q6025	
Q6027	
Q6028	
Q6032	
Q7001	

50 MHz MODULE: PA UNIT PARTS LAYOUT AND VOLT

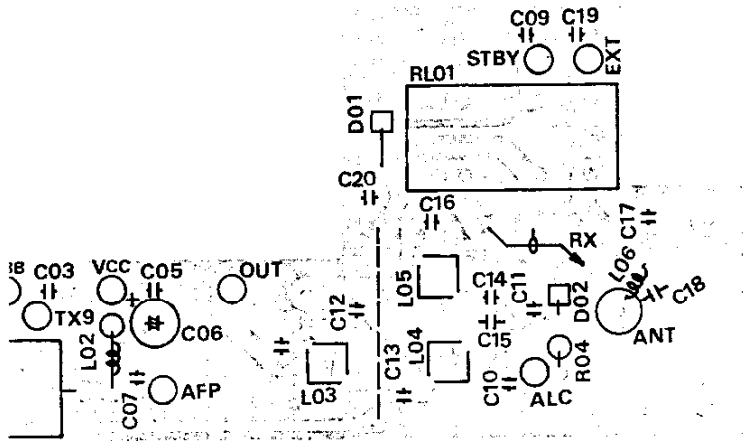

Viewed from component side

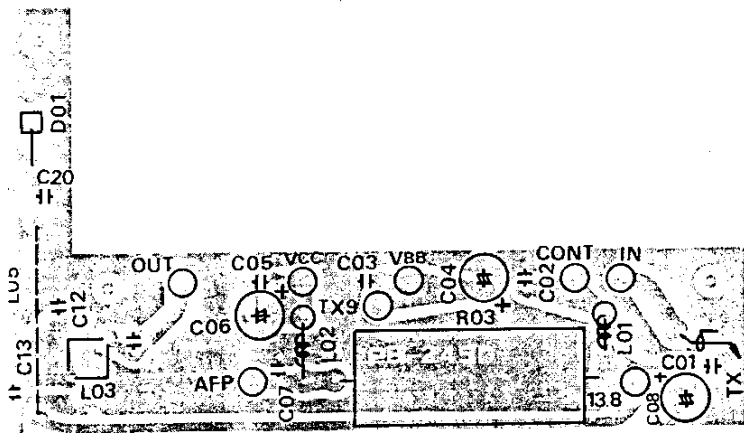

Viewed from solder side

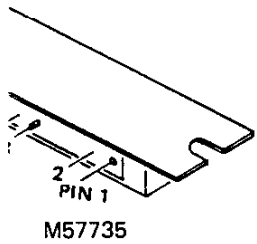

50 MHz MODULE VOLTAGE CHART (DC VOI

	E(S)		C(D)		B(G1)		(G2)		REM
	R	T	R	T	R	T	R	T	
Q5001	1.3		7.9		1.4		1.9		
Q5002	0.3		7.8		0		0.3		
Q5004		0.5		7.7		0			
Q5003	1.3		7.9			0			
Q5005		0.5		7.7		0			
Q5006		1.3		7.3		1.5		4.0	
Q5007		0.1		8.1		0.8			
Q5008		0		13.7		0.7			
Q5009		13.7		0		13.2			
Q5010		9.4		13.7		10.0			
Q5011		9.4		13.7		10.0			
Q5012		12.0		13.7		10.0			
Q6001	0.7		7.8		0				
Q6002	0.2		5.8		0				
Q6003	0.5		7.8		0.4		3.9		
Q6004	0		7.8		0				
Q6006	4.9		7.5		5.5				
Q6007	0.3		2.8		0.9				
Q6010	0.9		8.0		1.4				
Q6011	0.3		1.6		0				
Q6012	0		1.0		0.3				
Q6013	3.5		7.8		3.7				
Q6014	8.1		8.1		8.1				
Q6015	1.0		8.0		1.7				
Q6017	0.9		7.9		1.6				
Q6018	0		0		0.6				
Q6019	8.1		7.3		8.0				
Q6020	4.9		7.6		3.7				
Q6022	0		13.7		0				
Q6026	0		0		0.6				
Q6029	0		8.1		0				
Q6030	0		0		0.7				
Q6031	0		0.8		1.4				

	1	2	3	4	5	6	7	8	9
Q6005	6.3	3.8	2.7	0	2.7	3.8	3.8	7.6	
Q6008	8.1	3.1	0	0	0	0	0	0	7.8
Q6009	8.0	0	1.4	8.0	8.0	0	4.0	1.0	0
Q6016	0	7.7	6.9	3.9	2.6	0	0	-	2.6
Q6021	3.8	0	4.0	4.0	4.0	4.0	0	0	3.9
Q6023	0	0	0	0	0	0.2	0	0	0.2
Q6024	0	0	8.1	0	0	0	0	0	0.3
Q6025	0	0	8.1	0	0	0	0	0	0
Q6027	5.0	0	8.1						
Q6028	4.9	8.0	3.6	8.0	4.2	0	0.1	0	0
Q6032	13.7	0	8.1						
Q7001	0	13.7	0	13.7	0				

JNIT PARTS LAYOUT AND VOLTAGE CHARTS

50 MHz MODULE VOLTAGE CHART (DC VOLTS)

	E(S)		C(D)		B(G1)		(G2)		REMARKS
	R	T	R	T	R	T	R	T	
Q5001	1.3		7.9		1.4		1.9		
Q5002	0.3		7.8		0		0.3		
Q5004		0.5		7.7		0			
Q5003	1.3		7.9			0			
Q5005		0.5		7.7		0			
Q5006		1.3		7.3		1.5		4.0	
Q5007		0.1		8.1		0.8			
Q5008		0		13.7		0.7			
Q5009		13.7		0		13.2			
Q5010		9.4		13.7		10.0			
Q5011		9.4		13.7		10.0			
Q5012		12.0		13.7		10.0			
Q6001	0.7		7.8		0				
Q6002	0.2		5.8		0				
Q6003	0.5		7.8		0.4		3.9		
Q6004	0		7.8		0				
Q6006	4.9		7.5		5.5				
Q6007	0.3		2.8		0.9				
Q6010	0.9		8.0		1.4				
Q6011	0.3		1.6		0				
Q6012	0		1.0		0.3				
Q6013	3.5		7.8		3.7				
Q6014	8.1		8.1		8.1				
Q6015	1.0		8.0		1.7				
Q6017	0.9		7.9		1.6				
Q6018	0		0		0.6				
Q6019	8.1		7.3		8.0				
Q6020	4.9		7.6		3.7				
Q6022	0		13.7		0				
Q6026	0		0		0.6				
Q6029	0		8.1		0				
Q6030	0		0		0.7				
Q6031	0		0.8		1.4				

	1	2	3	4	5	6	7	8	9	10	11	12	13	14	15	16	17	18	REMARKS
Q6005	6.3	3.8	2.7	0	2.7	3.8	3.8	7.6											
Q6008	8.1	3.1	0	0	0	0	0	0	7.8	0	0	0	0	0	0	0	1.0	0	
Q6009	8.0	0	1.4	8.0	8.0	0	4.0	1.0	0										
Q6016	0	7.7	6.9	3.9	2.6	0	0	-	2.6	3.9	-	3.9	6.9	0					
Q6021	3.8	0	4.0	4.0	4.0	4.0	0	0	3.9	-	3.9	4.2	0	8.0					
Q6023	0	0	0	0	0	0.2	0	0	0.2	0	0	0	4.2	5.0					
Q6024	0	0	8.1	0	0	0	0	0	0.3	0	8.1	0	0	0	0	8.1			
Q6025	0	0	8.1	0	0	0	0	0	0	0	0	0	0	0	5.1	7.9			
Q6027	5.0	0	8.1																
Q6028	4.9	8.0	3.6	8.0	4.2	0	0.1	0	0	0	0	0	0	4.9	8.1	8.1			
Q6032	13.7	0	8.1																
Q7001	0	13.7	0	13.7	0														RX

FOR SERVICE MANUALS
CONTACT:
MAURITRON TECHNICAL SERVICES
www.mauritron.co.uk
TEL: 01844 - 351094
FAX: 01844 - 352554

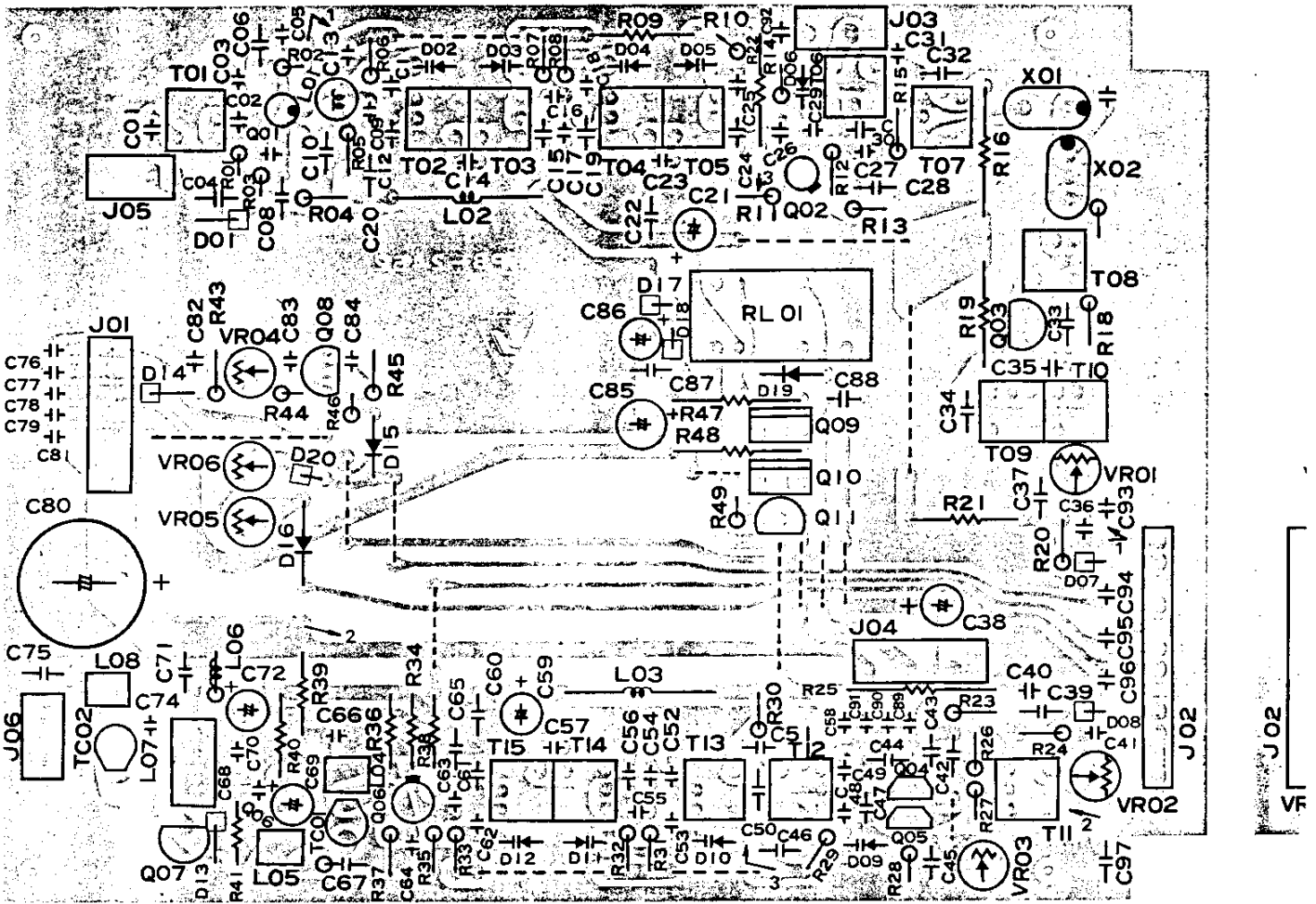

Viewed from component side

FOR SERVICE MANUALS
CONTACT:
MAURITRON TECHNICAL SERVICES
www.mauritron.co.uk
TEL: 01844 - 351694
FAX: 01844 - 352554

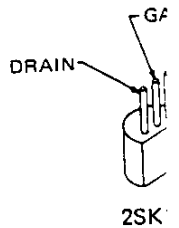
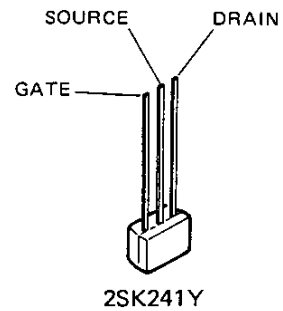
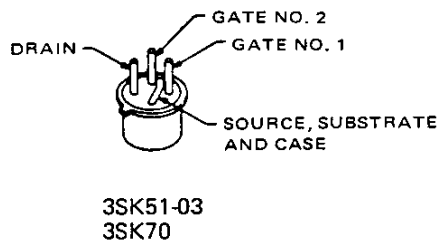
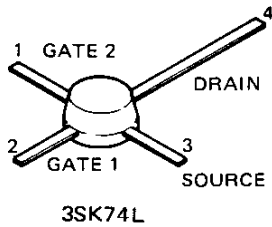

144MHz MODULE: RF UNIT PARTS LAYOUT

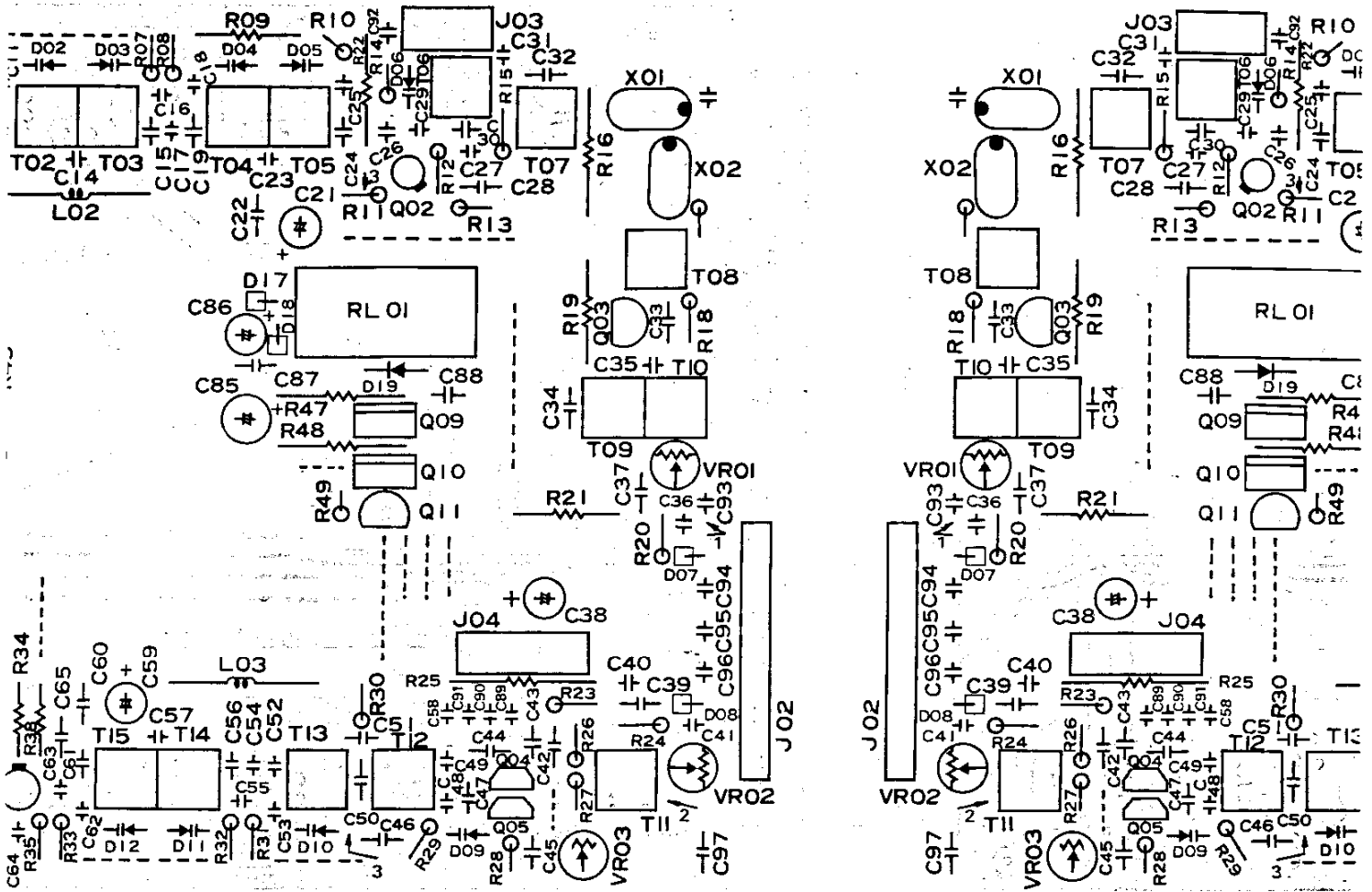

Viewed from component side

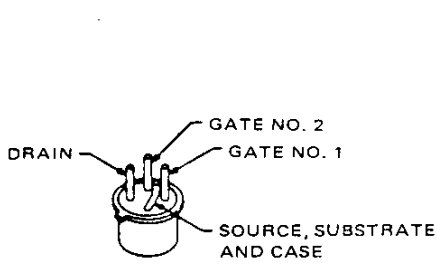

3SK51-03
3SK70

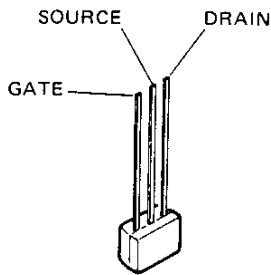

2SK241Y

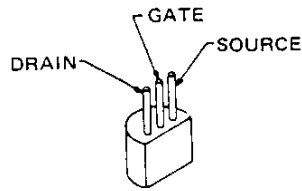

2SK125

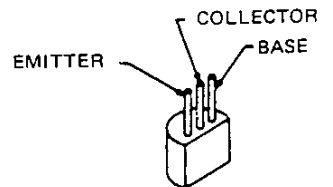

2SA733AQ

144MHz MODULE: PLL UNI

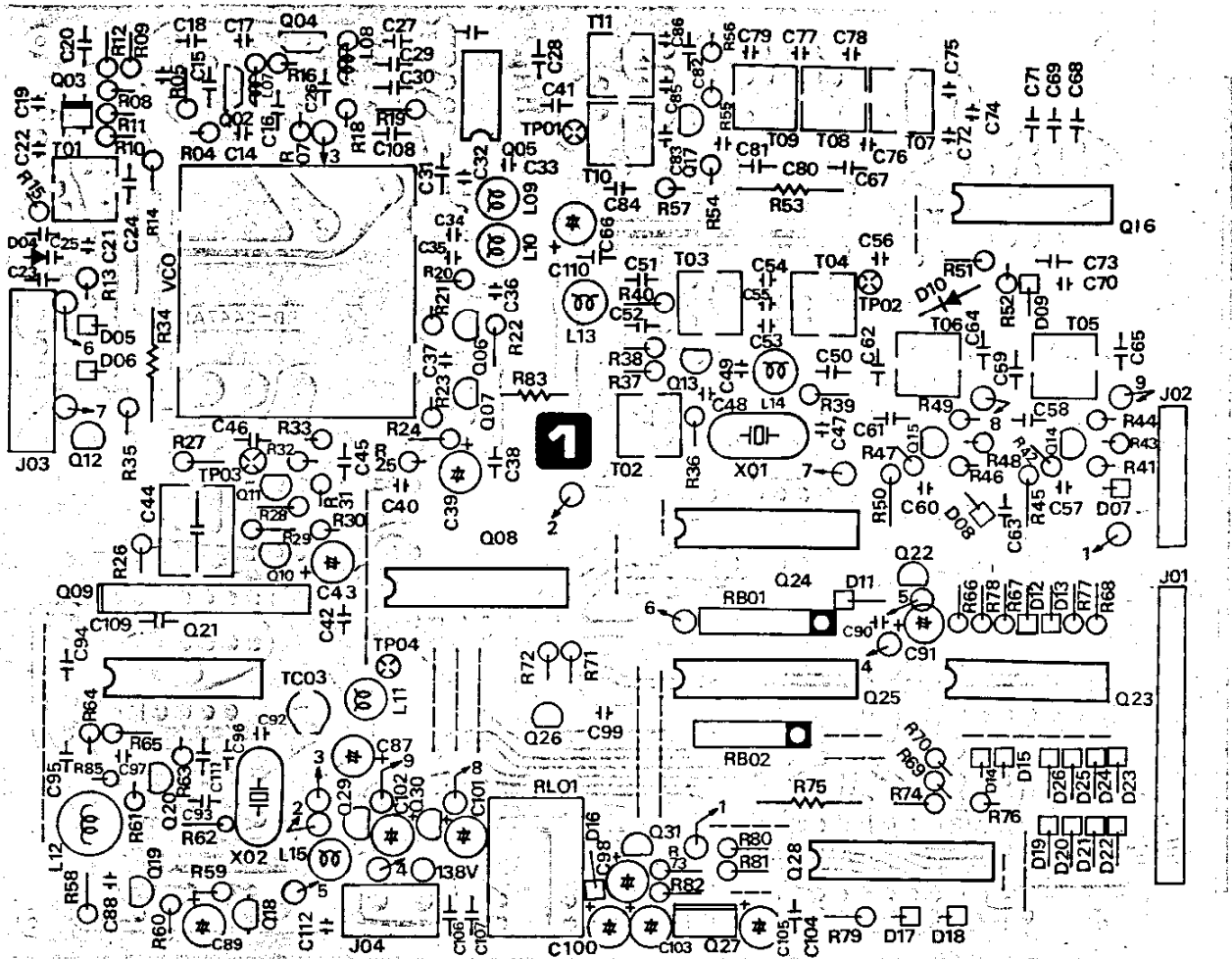

Viewed from component side

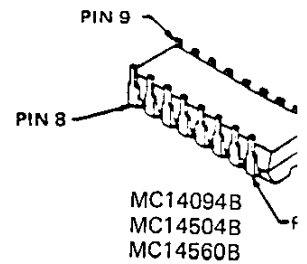
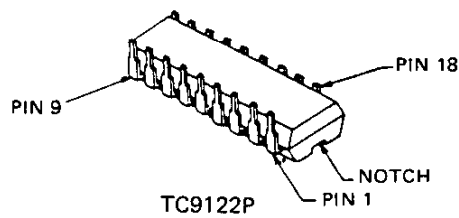
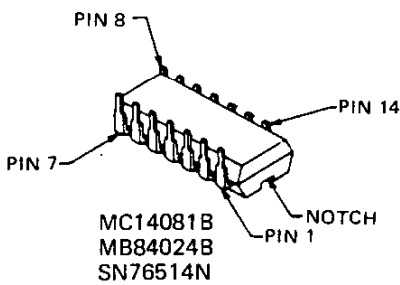
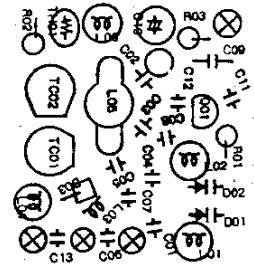
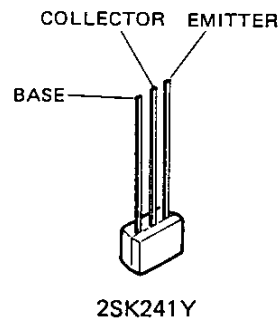
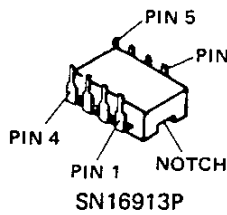
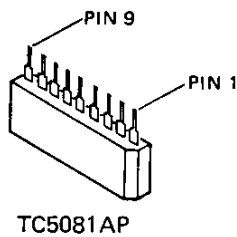

144MHz MODULE: PLL UNIT PARTS LAYOUT

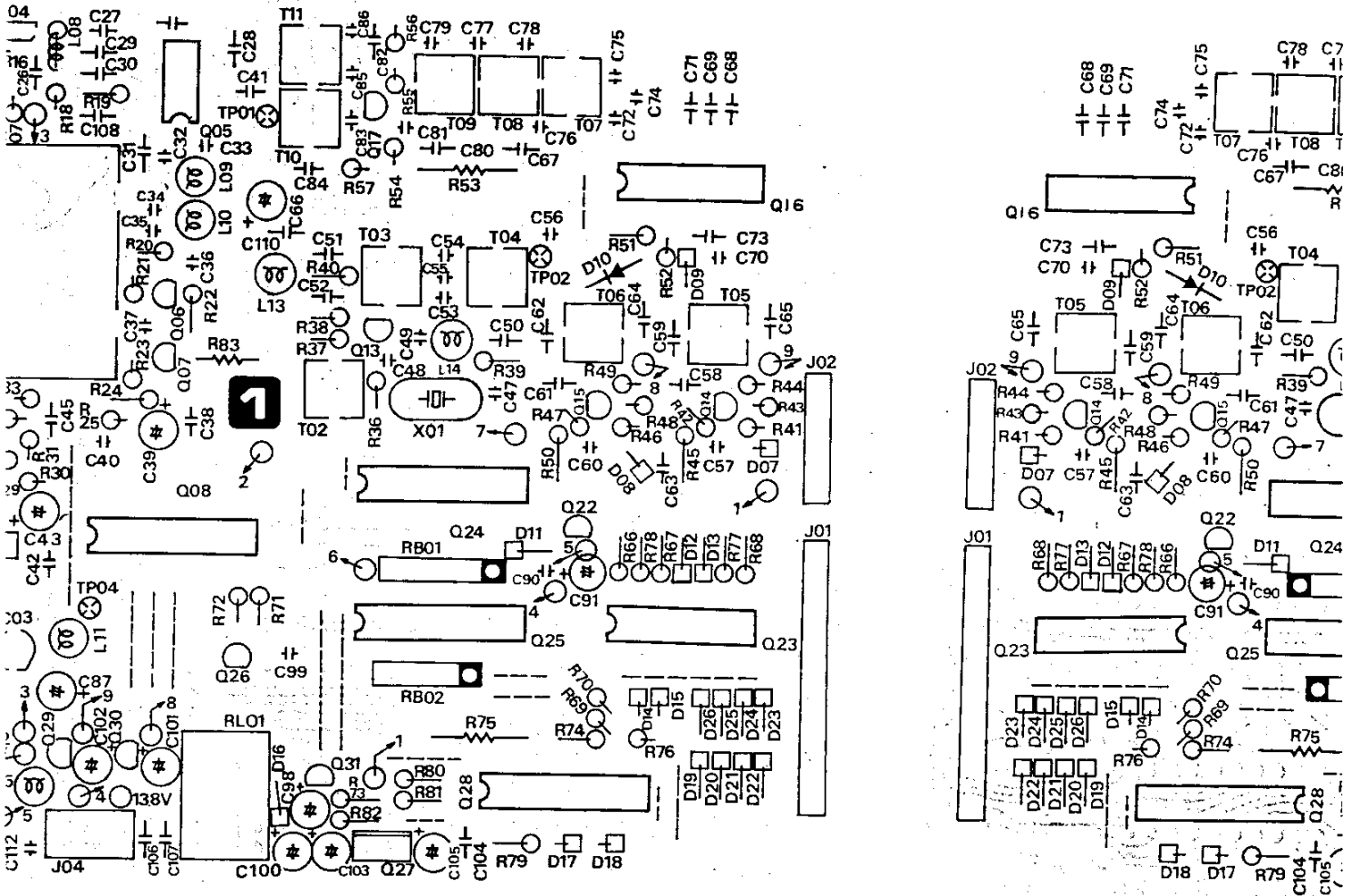

Viewed from component side

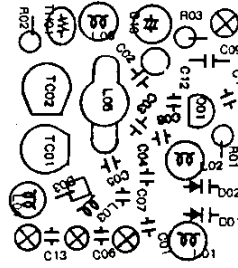
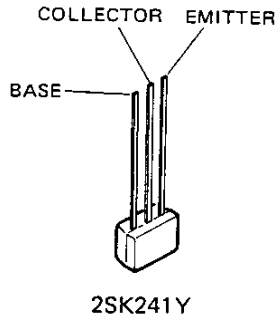
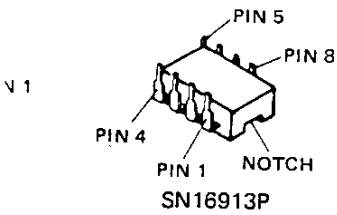

VCO UNIT

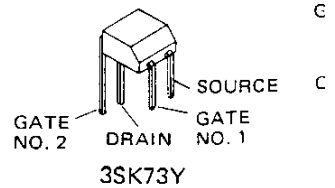
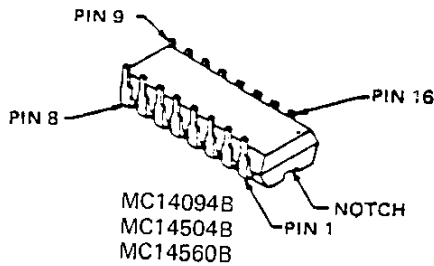
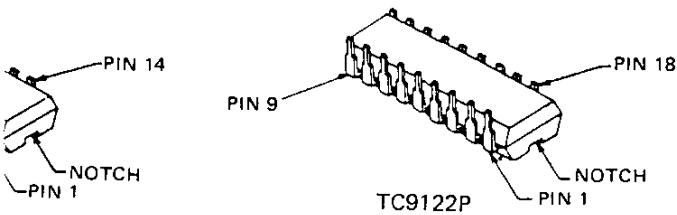
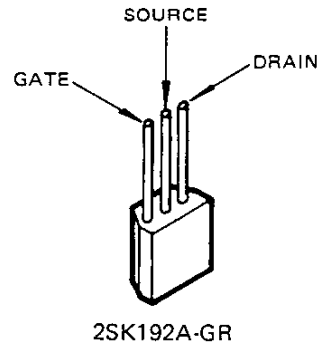

L UNIT PARTS LAYOUT

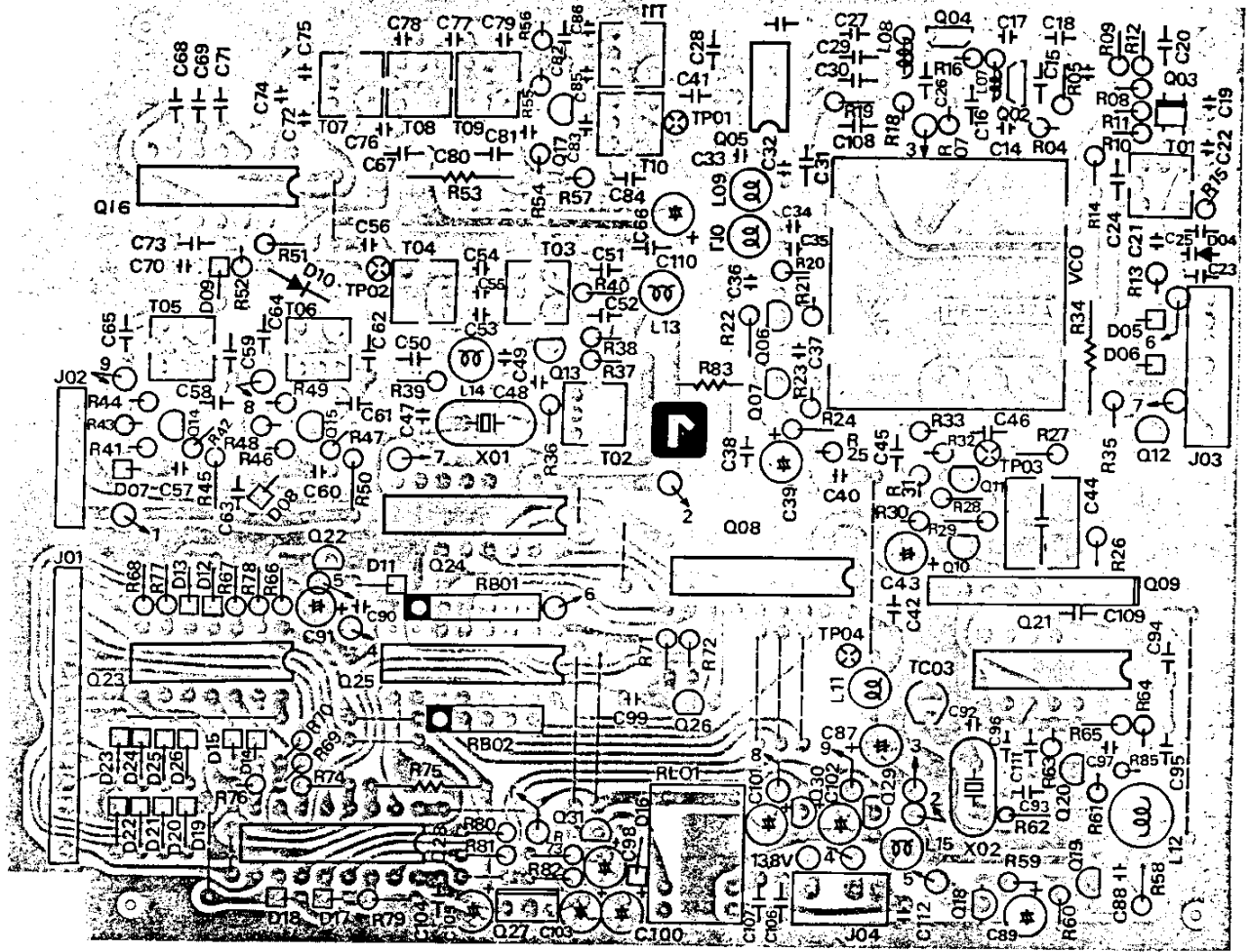

ent side

Viewed from solder side

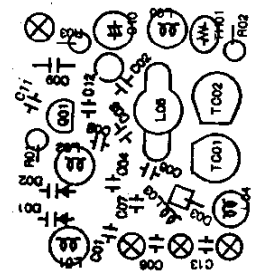
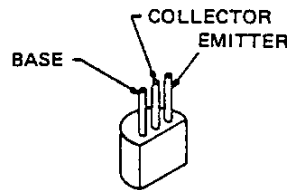
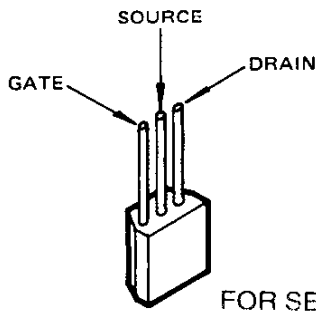
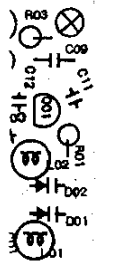

2SK192A-GR

CONTACT:

MAURITRON TECHNICAL SERVICES

www.mauritron.co.uk

TEL: 01844 351694

FAX: 01844 352554

2SA564A
2SC460B
2SC535B

2SC945AP
2SD892Q

VCO UNIT

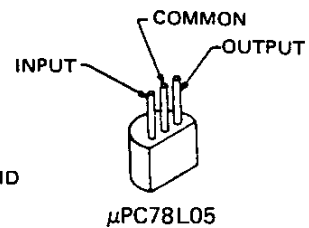
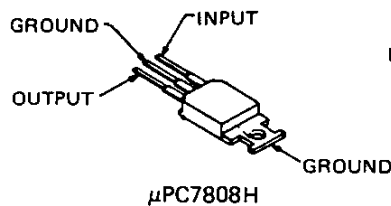
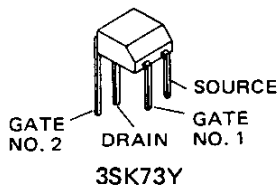
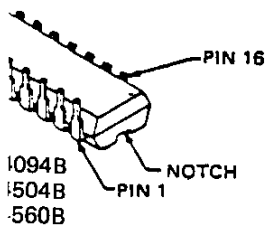

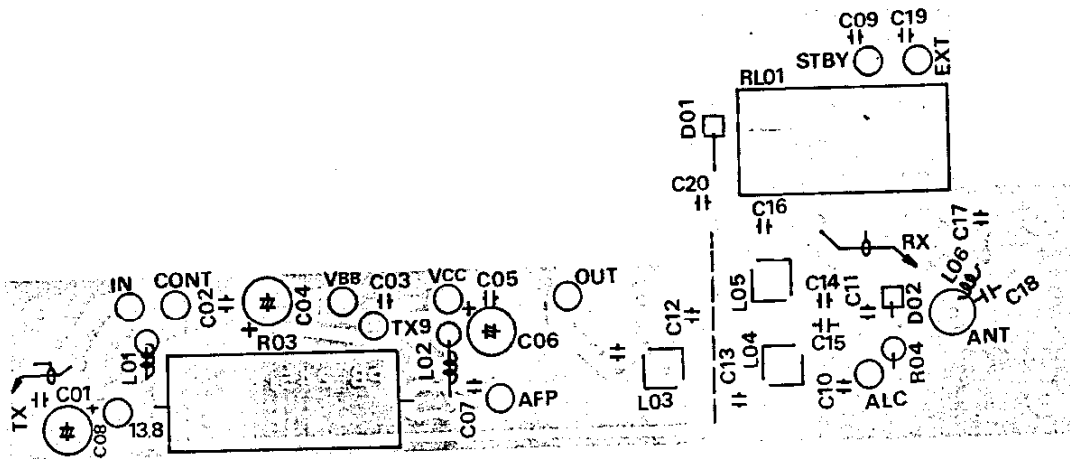

Viewed from component side

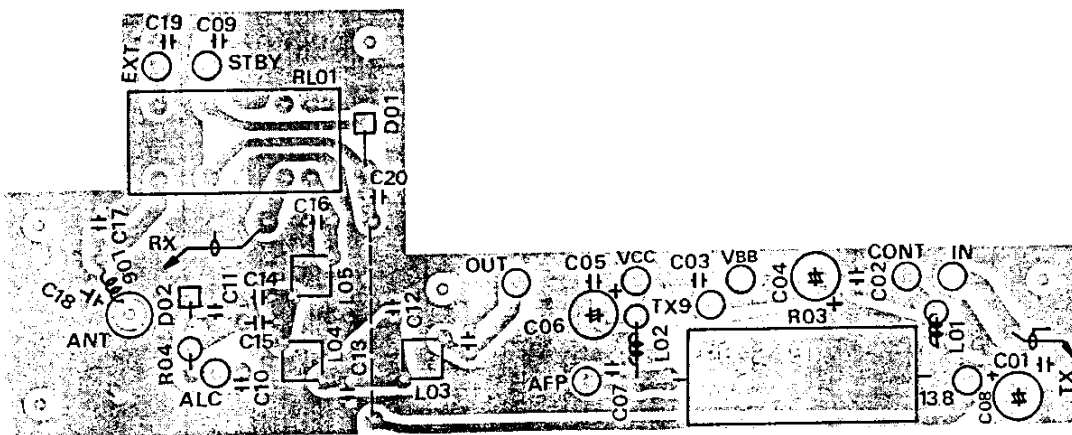

Viewed from solder side

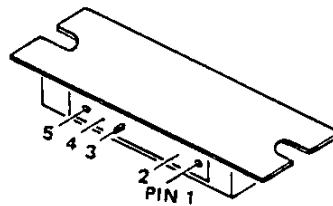

M57713

FOR SERVICE MANUALS
CONTACT:
MAURITRON TECHNICAL SERVICES

www.mauritron.co.uk
TEL: 01844 - 351694
FAX: 01844 - 352554

Q5001
Q5002
Q5003
Q5004
Q5005
Q5006
Q5007
Q5008
Q5009
Q5010
Q5011

Q6001
Q6002
Q6003
Q6004
Q6006
Q6007
Q6010
Q6011
Q6012
Q6013
Q6014
Q6015
Q6016
Q6017
Q6018
Q6019
Q6020
Q6021
Q6022
Q6023
Q6024
Q6025
Q6026
Q6027
Q6028
Q6029
Q6030
Q6031
Q6032
Q6033
Q6034
Q6035
Q6036
Q6037
Q6038
Q6039
Q6040
Q6041
Q6042
Q6043
Q6044
Q6045
Q6046
Q6047
Q6048
Q6049
Q6050
Q6051
Q6052
Q6053
Q6054
Q6055
Q6056
Q6057
Q6058
Q6059
Q6060
Q6061
Q6062
Q6063
Q6064
Q6065
Q6066
Q6067
Q6068
Q6069
Q6070
Q6071
Q6072
Q6073
Q6074
Q6075
Q6076
Q6077
Q6078
Q6079
Q6080
Q6081
Q6082
Q6083
Q6084
Q6085
Q6086
Q6087
Q6088
Q6089
Q6090
Q6091
Q6092
Q6093
Q6094
Q6095
Q6096
Q6097
Q6098
Q6099
Q6100

Q6001
Q6002
Q6003
Q6004
Q6005
Q6006
Q6007
Q6008
Q6009
Q6010
Q6011
Q6012
Q6013
Q6014
Q6015
Q6016
Q6017
Q6018
Q6019
Q6020
Q6021
Q6022
Q6023
Q6024
Q6025
Q6026
Q6027
Q6028
Q6029
Q6030
Q6031
Q6032
Q6033
Q6034
Q6035
Q6036
Q6037
Q6038
Q6039
Q6040
Q6041
Q6042
Q6043
Q6044
Q6045
Q6046
Q6047
Q6048
Q6049
Q6050
Q6051
Q6052
Q6053
Q6054
Q6055
Q6056
Q6057
Q6058
Q6059
Q6060
Q6061
Q6062
Q6063
Q6064
Q6065
Q6066
Q6067
Q6068
Q6069
Q6070
Q6071
Q6072
Q6073
Q6074
Q6075
Q6076
Q6077
Q6078
Q6079
Q6080
Q6081
Q6082
Q6083
Q6084
Q6085
Q6086
Q6087
Q6088
Q6089
Q6090
Q6091
Q6092
Q6093
Q6094
Q6095
Q6096
Q6097
Q6098
Q6099
Q6100

144MHz MODULE:PA UNIT PARTS LAYOUT AND VOLTAGE C

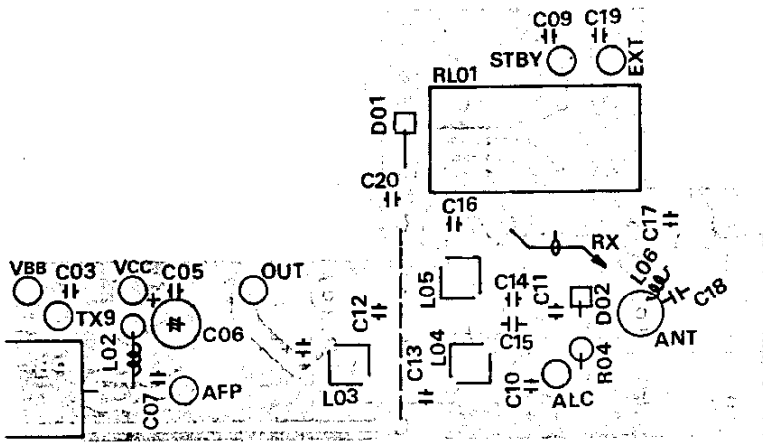

Viewed from component side

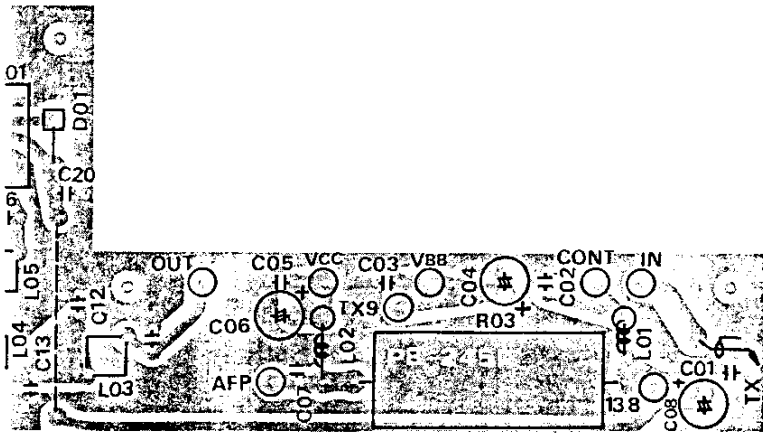

Viewed from solder side

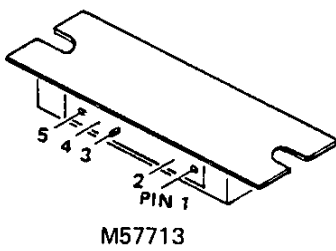

M57713

144 MHz MODULE VOLTAGE CHART (D

	E(S)		C(D)		B(G1)		(G2)	
	R	T	R	T	R	T	R	T
Q5001	1.7		7.9		1.4		2.5	
Q5002	0.2		7.8		0		0.2	
Q5003	1.4		7.9		0			
Q5004		0.7		7.9		0		
Q5005		0.7		7.9		0		
Q5006		1.5		13.4		1.5		4.1
Q5007		0		13.7		0.7		
Q5008		13.7		0		13.2		
Q5009		9.4		13.6		10.0		
Q5010		9.4		13.6		10.0		
Q5011		11.9		13.6		10.0		
Q6001	0.7		7.8		0			
Q6002	0.2		7.9		0			
Q6003	0.5		7.8		0.4		3.9	
Q6004	0		7.7		0			
Q6006	5.2		7.5		5.7			
Q6007	0.3		2.5		0.9			
Q6010	0.7		8.1		1.2			
Q6011	0.1		5.3		0.7			
Q6012	0		1.0		0.3			
Q6013	3.2		8.1		3.9			
Q6014	8.1		8.1		8.0			
Q6015	1.0		8.0		1.7			
Q6017	0.9		7.9		1.6			
Q6018	0		1.5		0			
Q6019	8.2		0		8.0			
Q6020	4.6		7.7		3.8			
Q6022	0		0.9		1.5			
Q6026	0		0		0.6			
Q6029	0		8.1		0			
Q6030	0		0		0.7			
Q6031	0		1.4		0.8			

	1	2	3	4	5	6	7	8
Q6005	6.3	3.8	2.7	0	2.7	3.8	3.8	7.6
Q6008	8.2	3.3	0	0	0	0	7.4	0
Q6009	8.2	0	1.2	8.1	8.2	-	4.1	0.8
Q6016	0	7.8	6.9	3.9	2.6	0	0	-
Q6021	3.8	0	4.1	4.1	4.1	4.0	0	-
Q6023	4.2	0	0	0	0	0.1	0	0
Q6024	0	0	8.2	7.4	0	0	0	0
Q6025	0	0	8.1	0	0	0	0	0
Q6027	5.0	0	8.2					
Q6028	5.0	8.1	3.6	8.1	4.2	0	0.1	0
Q6032	13.7	0	8.2					
Q7001	0	13.7	9.2	13.6	0			

PARTS LAYOUT AND VOLTAGE CHARTS

144 MHz MODULE VOLTAGE CHART (DC VOLTS)

	E(S)		C(D)		B(G1)		(G2)		REMARKS
	R	T	R	T	R	T	R	T	
Q5001	1.7		7.9		1.4		2.5		
Q5002	0.2		7.8		0		0.2		
Q5003	1.4		7.9		0				
Q5004		0.7		7.9		0			
Q5005		0.7		7.9		0			
Q5006		1.5		13.4		1.5		4.1	
Q5007		0		13.7		0.7			
Q5008		13.7		0		13.2			
Q5009		9.4		13.6		10.0			
Q5010		9.4		13.6		10.0			
Q5011		11.9		13.6		10.0			
Q6001	0.7		7.8		0				
Q6002	0.2		7.9		0				
Q6003	0.5		7.8		0.4		3.9		
Q6004	0		7.7		0				
Q6006	5.2		7.5		5.7				
Q6007	0.3		2.5		0.9				
Q6010	0.7		8.1		1.2				
Q6011	0.1		5.3		0.7				
Q6012	0		1.0		0.3				
Q6013	3.2		8.1		3.9				
Q6014	8.1		8.1		8.0				NOR VFO
Q6015	1.0		8.0		1.7				NOR VFO
Q6017	0.9		7.9		1.6				
Q6018	0		1.5		0				
Q6019	8.2		0		8.0				
Q6020	4.6		7.7		3.8				
Q6022	0		0.9		1.5				
Q6026	0		0		0.6				
Q6029	0		8.1		0				NOR VFO
Q6030	0		0		0.7				NOR VFO
Q6031	0		1.4		0.8				

	1	2	3	4	5	6	7	8	9	10	11	12	13	14	15	16	17	18	REMARKS
Q6005	6.3	3.8	2.7	0	2.7	3.8	3.8	7.6											
Q6008	8.2	3.3	0	0	0	0	7.4	0	7.4	0	0	0	0	0	0	0	0.8	0	
Q6009	8.2	0	1.2	8.1	8.2	-	4.1	0.8	0										
Q6016	0	7.8	6.9	3.9	2.6	0	0	-	2.6	3.9	3.9	3.9	6.9	-					
Q6021	3.8	0	4.1	4.1	4.1	4.0	0	-	4.0	-	3.9	4.2	-	8.2					
Q6023	4.2	0	0	0	0	0.1	0	0	0.1	0	4.9	4.8	4.2	5.0					
Q6024	0	0	8.2	7.4	0	0	0	0	0.3	8.2	0	0	8.2	0	7.4	8.2			
Q6025	0	0	8.1	0	0	0	0	0	0	0	7.4	0	7.4	5.2	7.4				
Q6027	5.0	0	8.2																
Q6028	5.0	8.1	3.6	8.1	4.2	0	0.1	0	0	0	0	0	4.9	8.1	8.2				
Q6032	13.7	0	8.2																
Q7001	0	13.7	9.2	13.6	0														TX

FOR SERVICE MANUALS
 CONTACT:
MAURITRON TECHNICAL SERVICES
 www.mauritron.co.uk
 TEL: 01844 - 351694
 FAX: 01844 - 352554

FOR SERVICE MANUALS
CONTACT:
MAURITRON TECHNICAL SERVICES
www.mauritron.co.uk
TEL: 01844 - 351694
FAX: 01844 - 352554

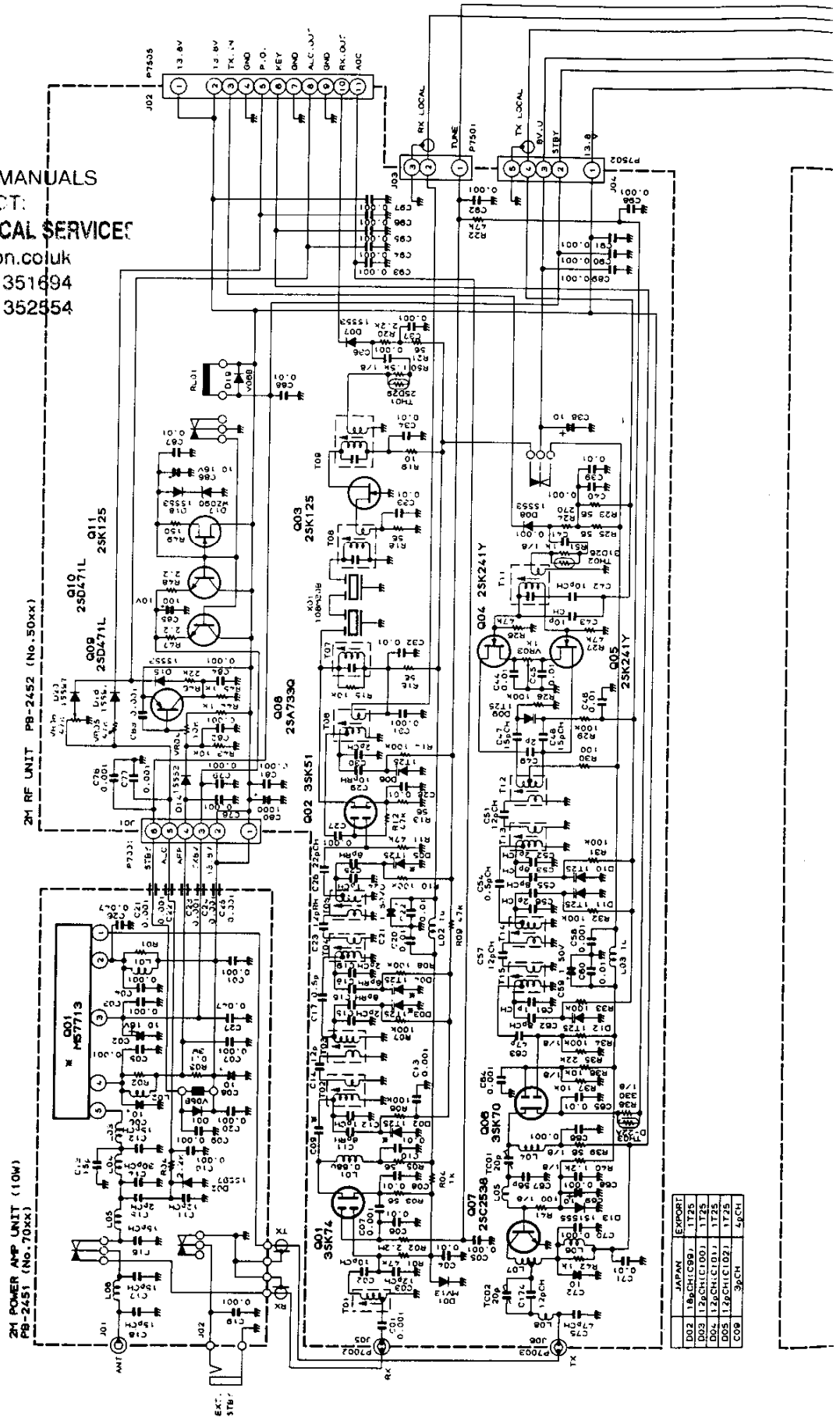

JAPAN	EXPORT
Q02 1B2CH(C)B9	1T26
Q03 1Z2CH(C)D01	1T25
Q04 1Z2CH(C)D11	1T25
Q05 1Z2CH(C)D21	1T25
C09 36CH	46CH

144MHz MODULE SCHEMATIC DIAGR

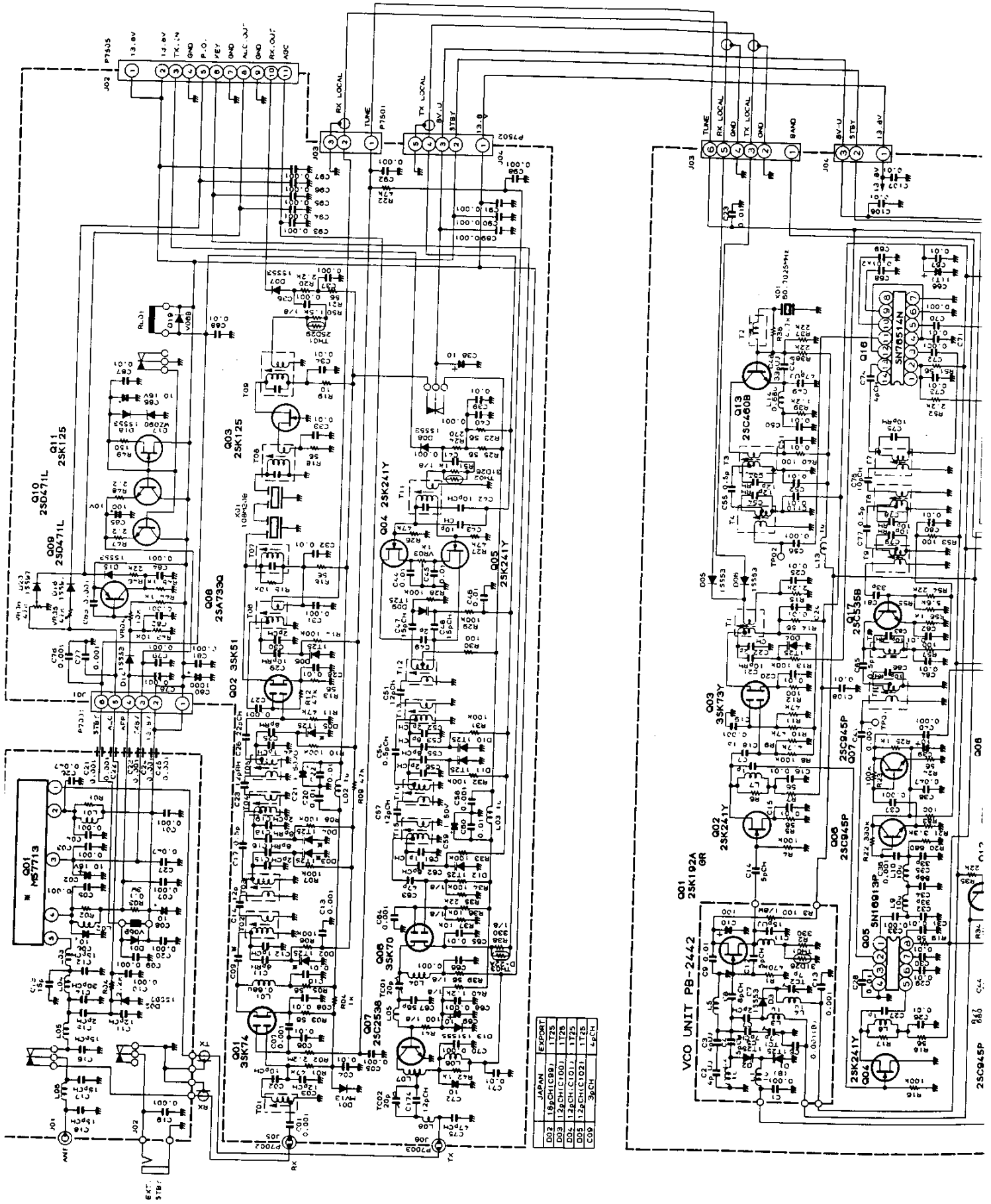

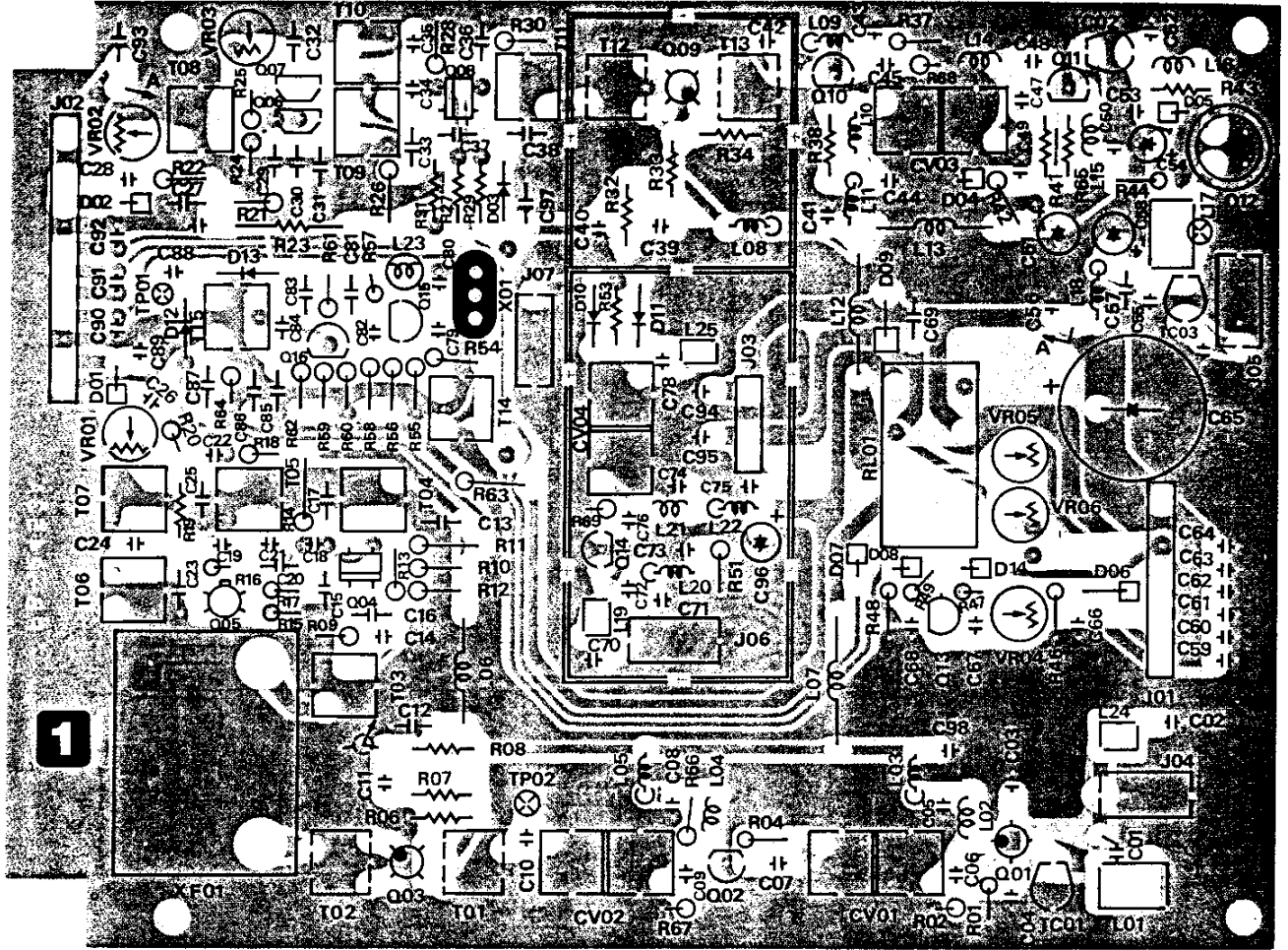

Viewed from component side

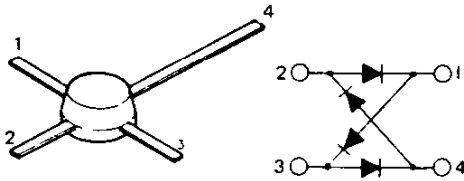

ND487C1-3R
ND487C2-3R

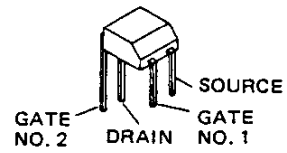

3SK73Y

SOURCE
GATE —

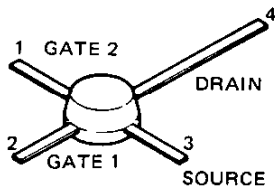

3SK121

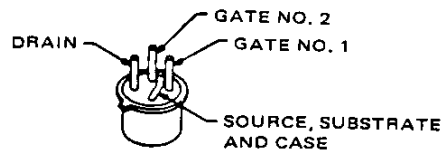

3SK51-03

430 AND 440 MHz MODULES: RF UNIT PART

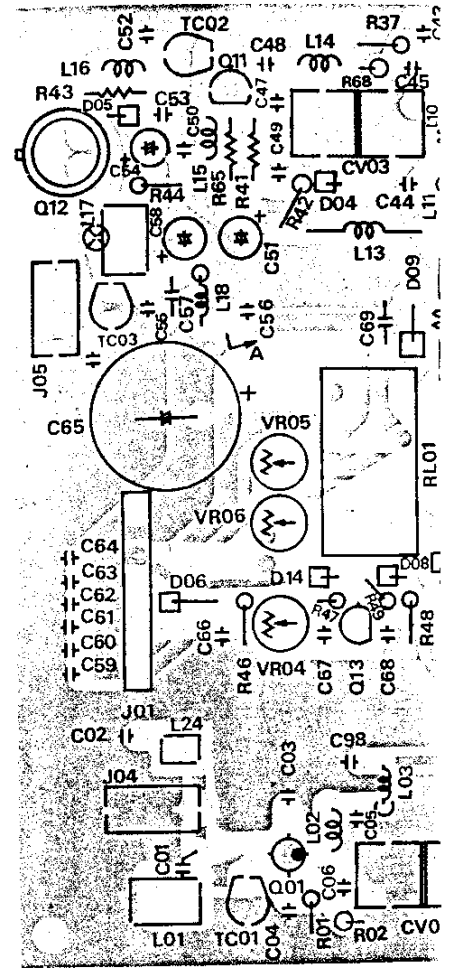
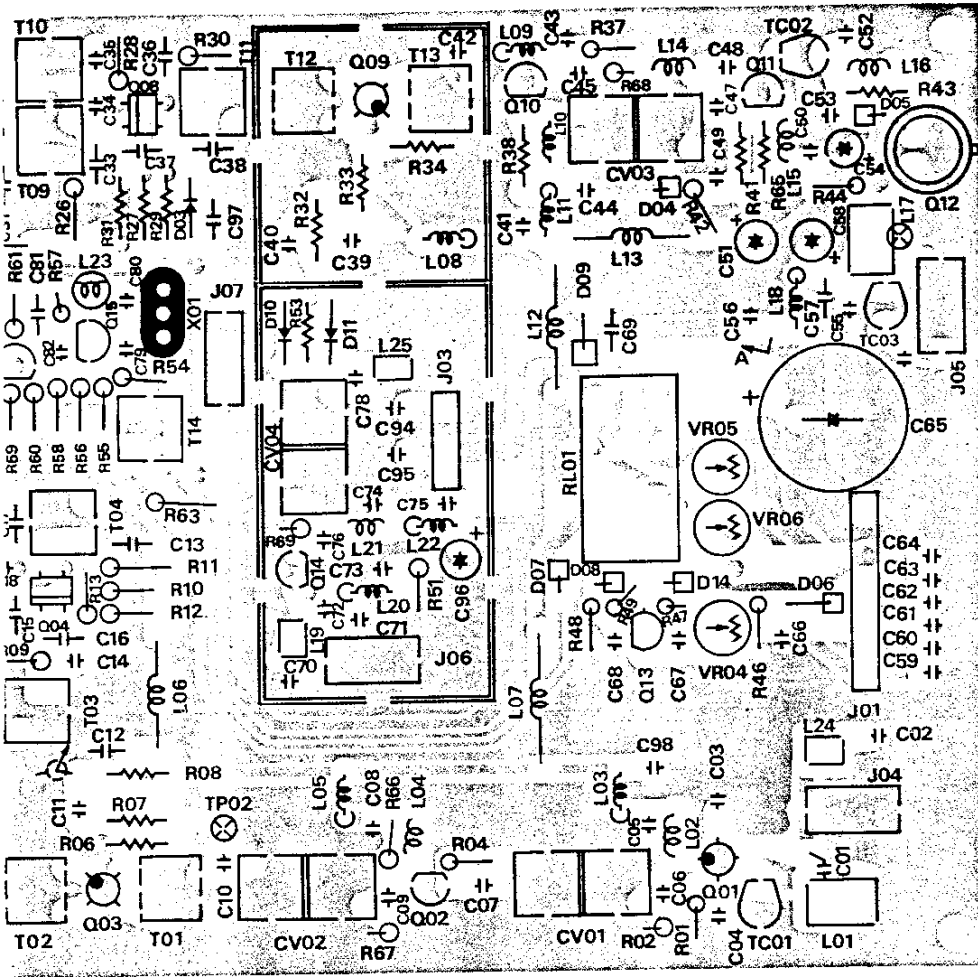

Viewed from component side

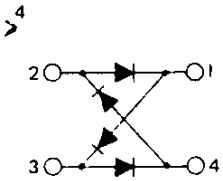

1-3R
2-3R

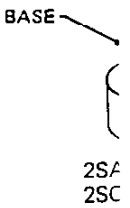
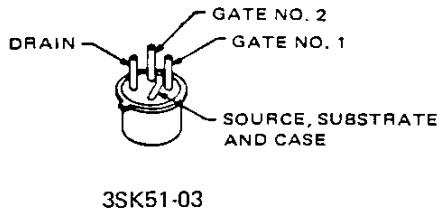
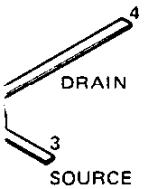
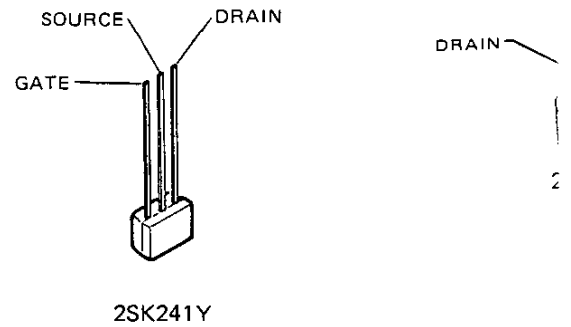
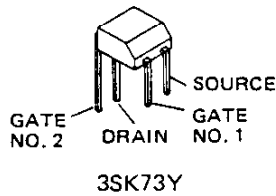

MHz MODULES: RF UNIT PARTS LAYOUT

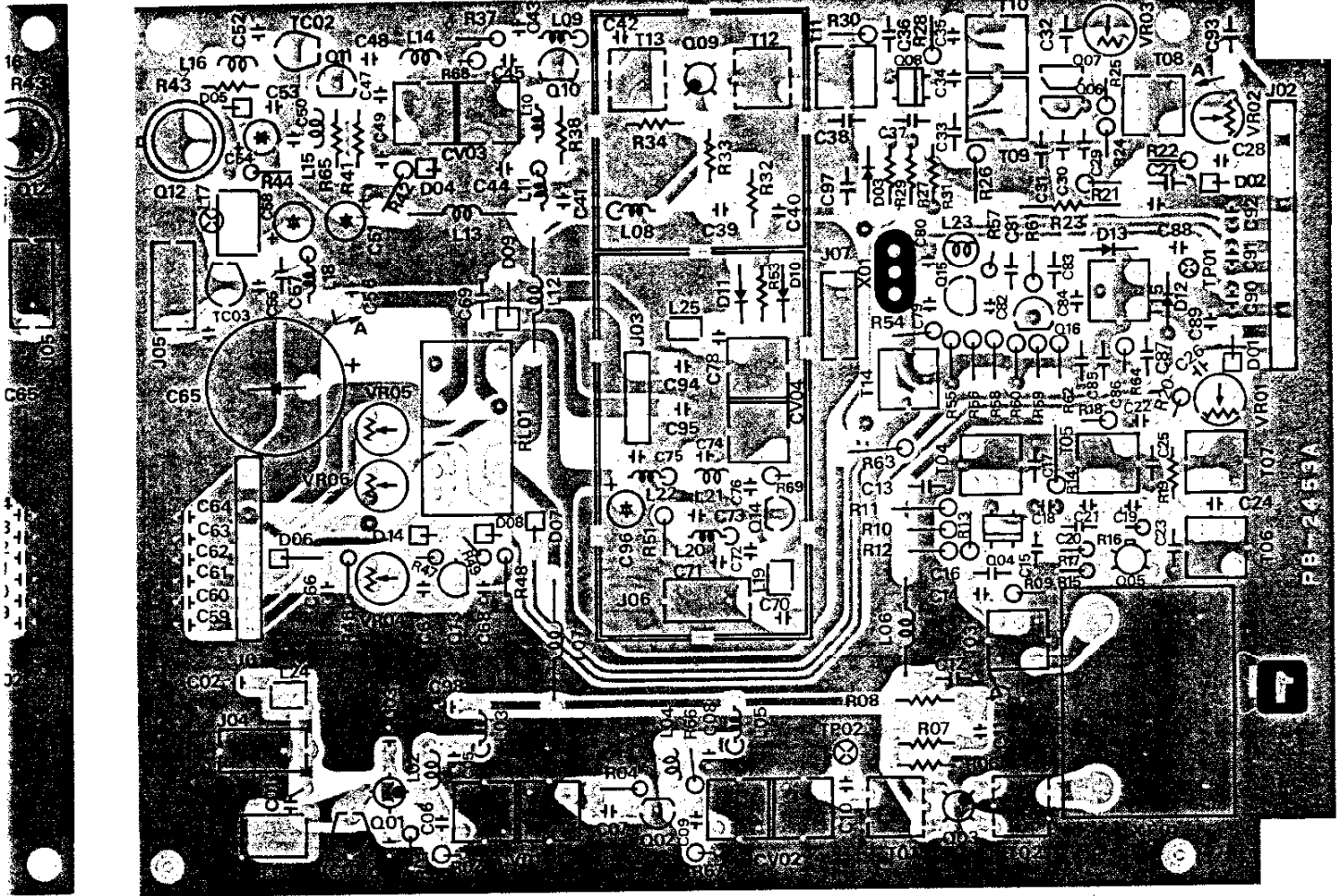

it side

Viewed from solder side

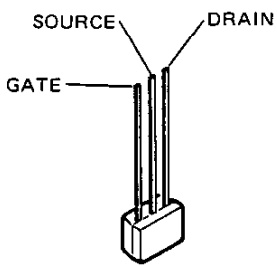

2SK241Y

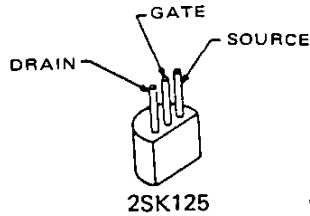

2SK125

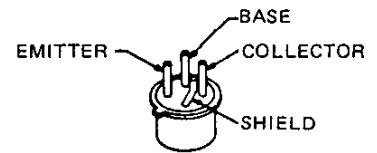

2SC1426

FOR SERVICE MANUALS
CONTACT:
MAURITRON TECHNICAL SERVICES

www.mauritron.co.uk
TEL: 01844 - 351694
FAX: 01844 - 352554

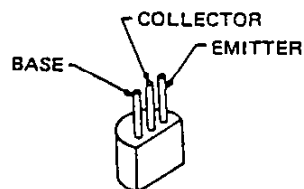

2SA733AQ
2SC460B

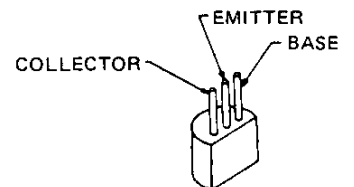

2SC2407

430 AND 440 MHz MODULES:

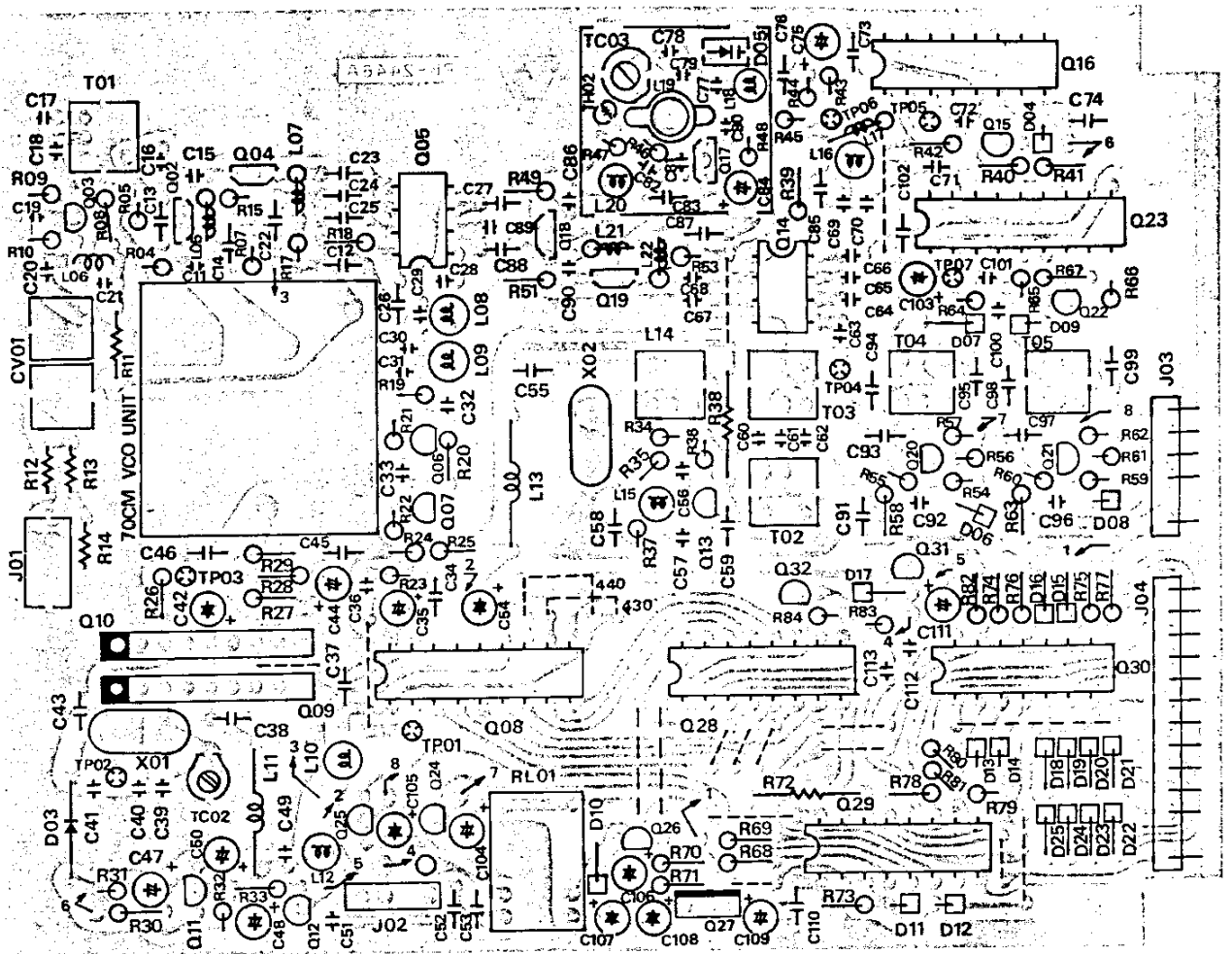

FOR SERVICE MANUALS
CONTACT:

MAURITRON TECHNICAL SERVICES

www.mauritron.co.uk
TEL: 01844 - 351694
FAX: 01844 - 352554

Viewed from component side

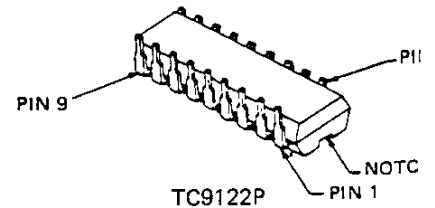
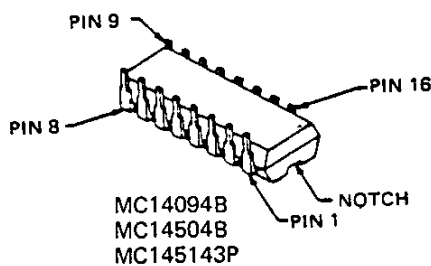
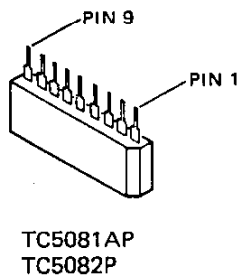
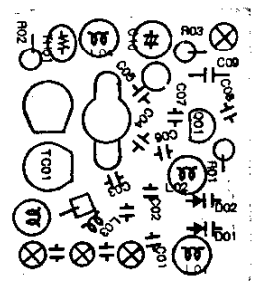
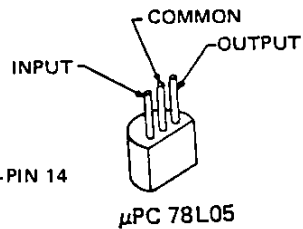
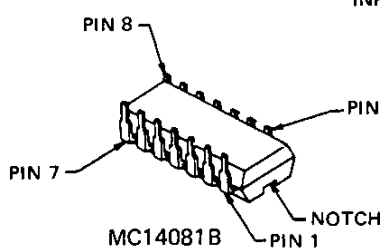
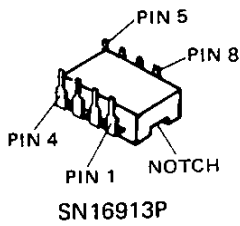

430 AND 440 MHz MODULES: PLL UNIT PARTS LAYOUT

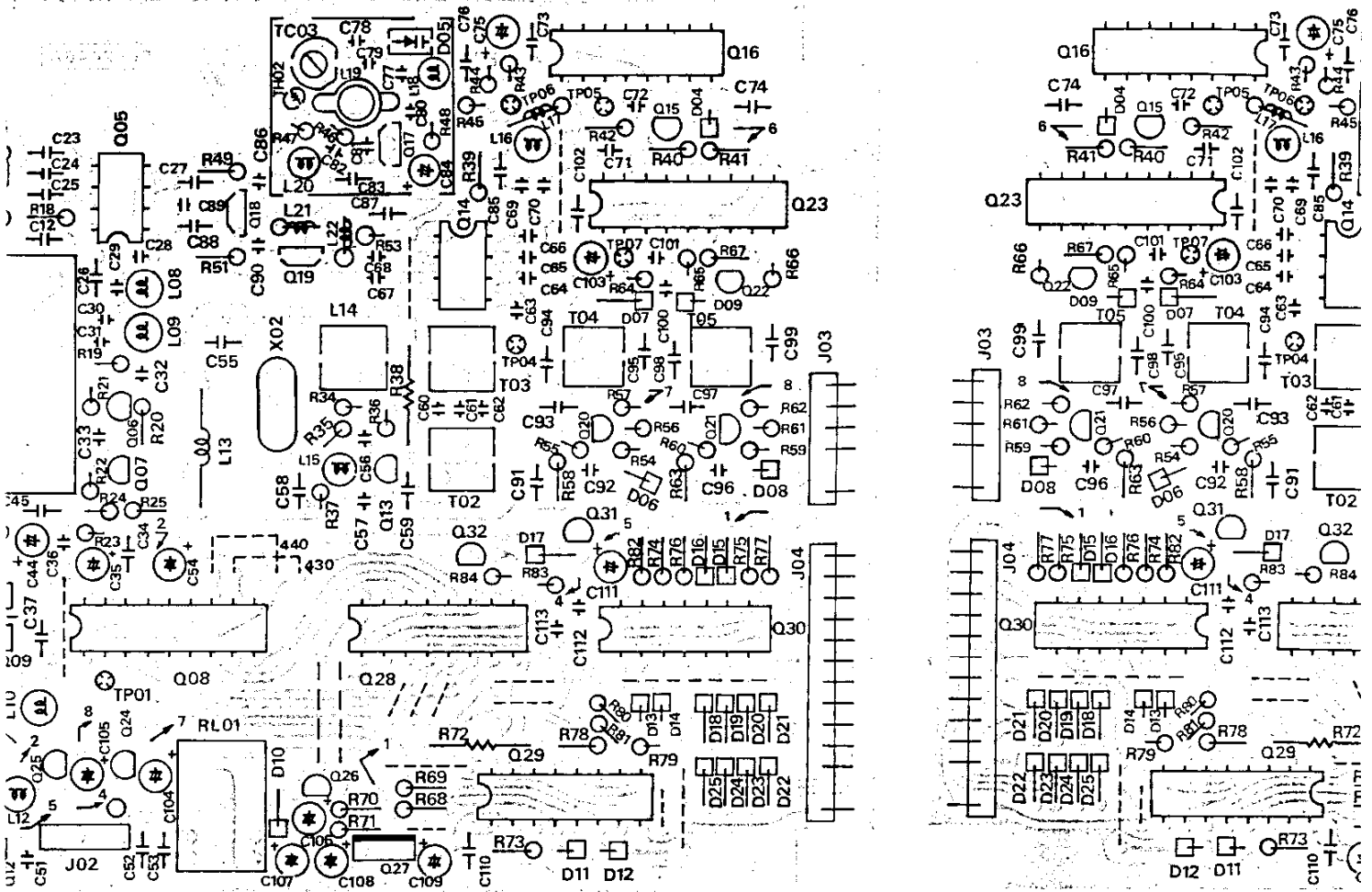

Viewed from component side

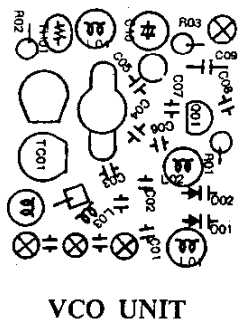
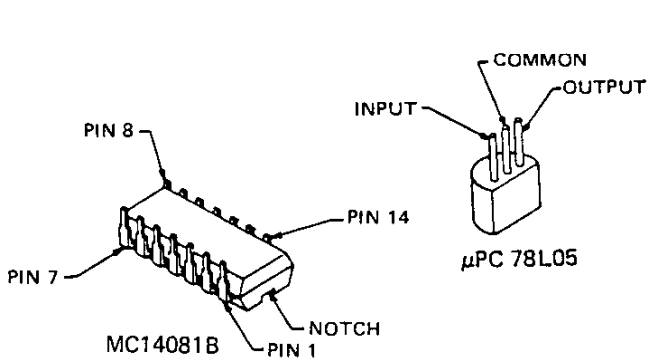

VCO UNIT

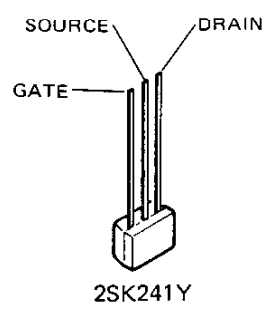

2SK241Y

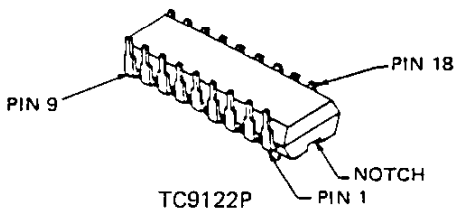
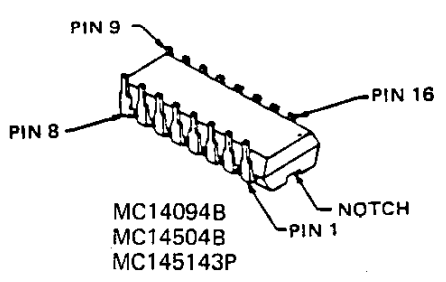

TC9122P

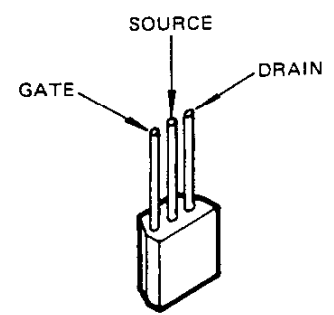

2SK192A-GR

DULES: PLL UNIT PARTS LAYOUT

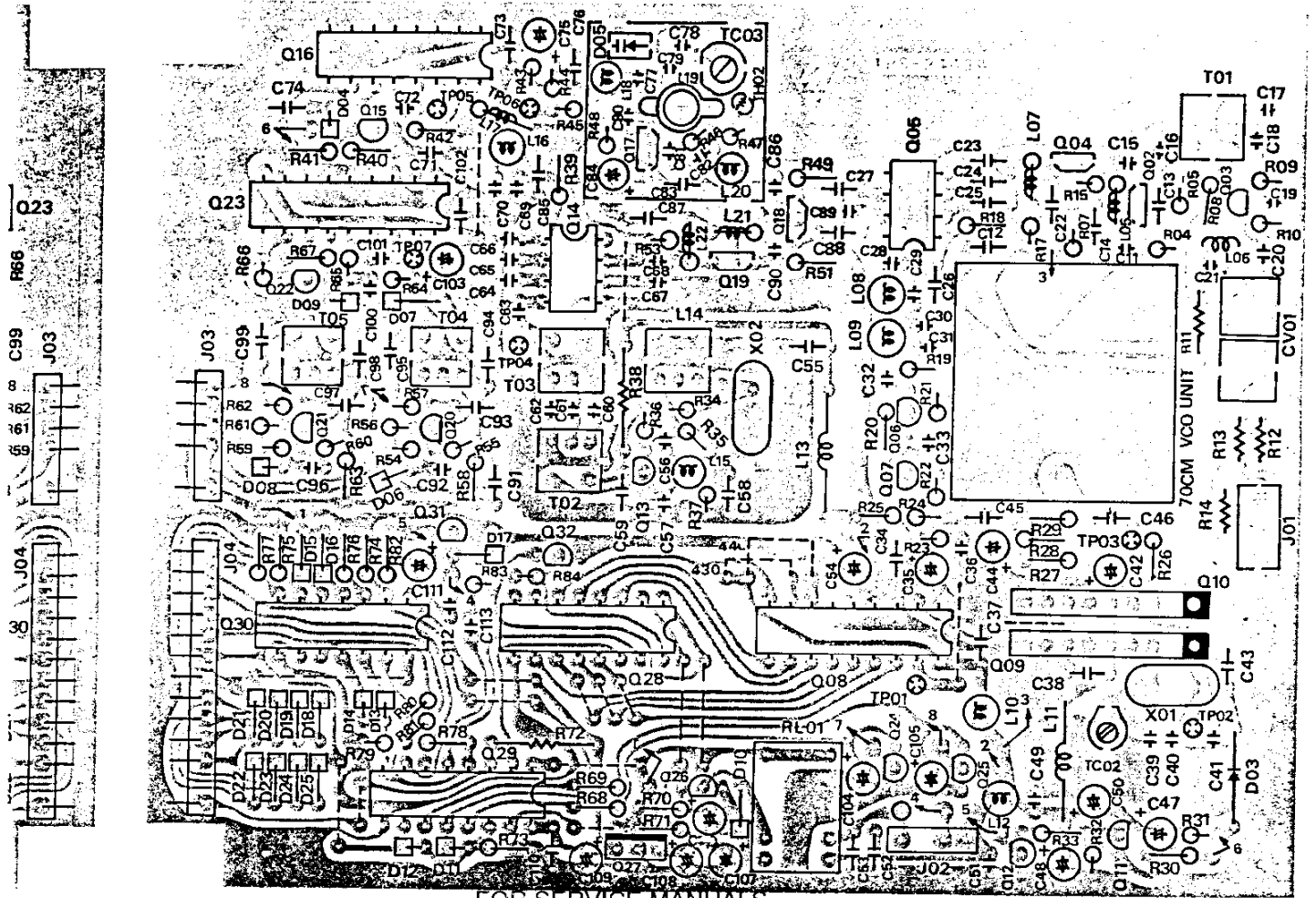

front side

Viewed from solder side

FOR SERVICE MANUALS

CONTACT:

MAURITRON TECHNICAL SERVICES

www.mauritron.co.uk

TEL: 01844 - 351694

FAX: 01844 - 352554

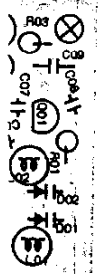

IT

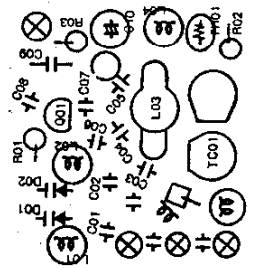
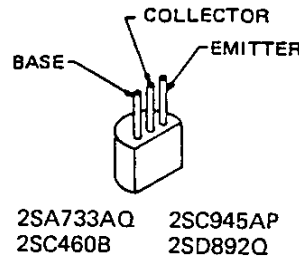
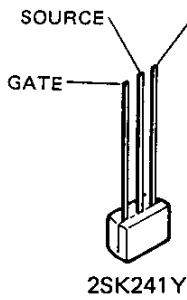

VCO UNIT

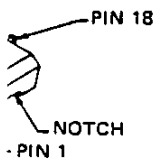
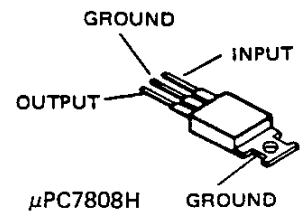
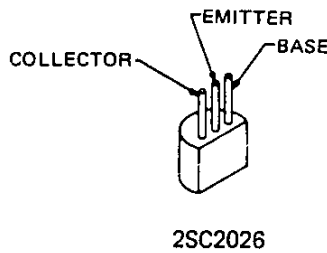
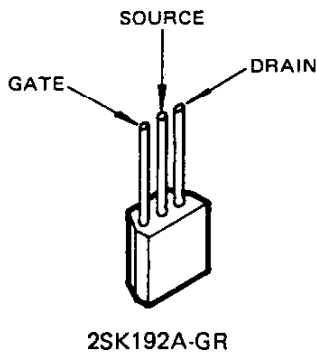

430 AND 440 MHz MODULES: PA UNIT PARTS LAYOUT

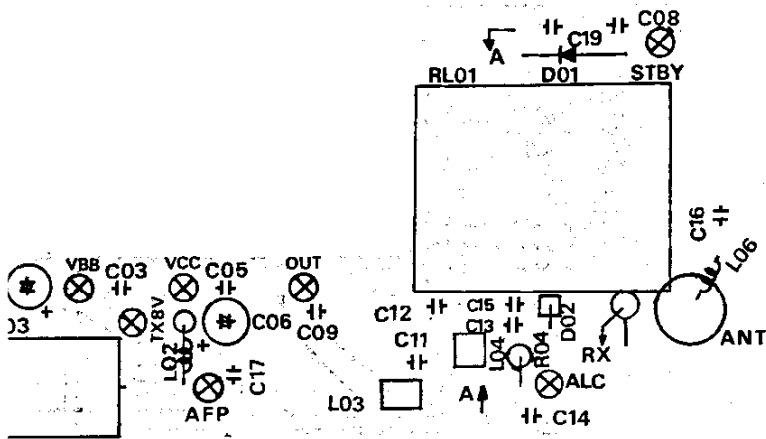

Viewed from component side

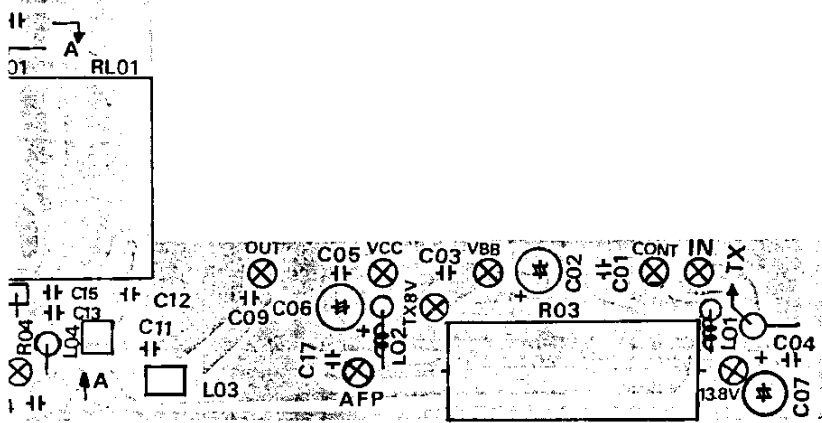

Viewed from solder side

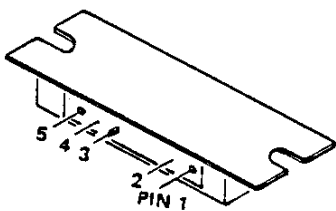

S-AU4

430 MHz MODULE VOLTAGE CHART

	E(S)		C(D)		B(G1)		(
	R	T	R	T	R	T	
Q5001	1.6		8.1		0		1.6
Q5002	1.4		8.1		0		
Q5004	1.3		7.8		1.5		0
Q5005	0.4		7.9		0		0.4
Q5006		0.6		7.9		0	
Q5007		0.6		7.9		0	
Q5008		1.4		7.3		1.4	
Q5010		1.4		8.0		0	
Q5011		0		8.0		0.7	
Q5012		0		13.7		0.7	
Q5013	13.7		0		13.2		
Q5014	0		7.3		0.7		
Q5015	7.8		3.0		3.7		
Q5016	7.8		0.9		1.6		
Q6001	0.7		7.8		0		
Q6002	0.2		7.9		0		
Q6003	1.3		8.0		1.8		
Q6004	0		7.6		0		
Q6006	5.4		7.5		5.8		
Q6007	0.4		3.6		1.0		
Q6011	8.1		0		7.9		
Q6012	0		1.5		0		
Q6013	3.1		7.9		3.7		
Q6015	0.2		3.7		0.9		
Q6017	0.7		7.8		0		
Q6018	0		7.4		0		
Q6019	0		7.3		0		
Q6020	1.1		8.0		1.7		
Q6021	8.1		8.1		8.1		
Q6022	0.4		3.8		1.0		
Q6024	0		0		0.7		
Q6025	0		8.1		0		
Q6026	0		8.0		1.4		
Q6031	0		13.7		0.1		
Q6032	0		0		0.6		

	1	2	3	4	5	6	7
Q6005	6.2	3.7	2.6	0	2.6	3.7	3.7
Q6008	8.1	3.3	0	0	0	0	0
Q6009	2.3	3.3	3.5	4.0	8.0	4.0	4.0
Q6010	0	2.2	8.0	8.0	8.0	0.4	4.0
Q6014	6.0	3.6	2.6	0	2.6	3.7	3.7
Q6016	7.8	0.4	4.1	4.1	4.4	7.8	0
Q6023	7.8	3.2	0	7.8	7.8	0	7.8
Q6027	4.9	0	8.1				
Q6028	0	0	8.1	0	0	0	0
Q6029	4.9	8.1	3.7	8.0	4.2	0	0
Q6030	4.2	0	0	0	0	0.1	0
Q6033	13.7	0	8.1				
Q7001	0	13.7	8.1	13.6	0		

RULES: PA UNIT PARTS LAYOUT AND VOLTAGE CHARTS

430 MHz MODULE VOLTAGE CHART (DC VOLTS)

	E(S)		C(D)		B(G1)		(G2)		REMARKS
	R	T	R	T	R	T	R	T	
Q5001	1.6		8.1		0		1.6		
Q5002	1.4		8.1		0				
Q5004	1.3		7.8		1.5		0		
Q5005	0.4		7.9		0		0.4		
Q5006		0.6		7.9		0			
Q5007		0.6		7.9		0			
Q5008		1.4		7.3		1.4		3.9	
Q5010		1.4		8.0		0			
Q5011		0		8.0		0.7			
Q5012		0		13.7		0.7			
Q5013	13.7		0		13.2				
Q5014	0		7.3		0.7				
Q5015	7.8		3.0		3.7				
Q5016	7.8		0.9		1.6				
Q6001	0.7		7.8		0				
Q6002	0.2		7.9		0				
Q6003	1.3		8.0		1.8				
Q6004	0		7.6		0				
Q6006	5.4		7.5		5.8				
Q6007	0.4		3.6		1.0				
Q6011	8.1		0		7.9				
Q6012	0		1.5		0				
Q6013	3.1		7.9		3.7				
Q6015	0.2		3.7		0.9				
Q6017	0.7		7.8		0				
Q6018	0		7.4		0				
Q6019	0		7.3		0				
Q6020	1.1		8.0		1.7				
Q6021	8.1		8.1		8.1				
Q6022	0.4		3.8		1.0				
Q6024	0		0		0.7				
Q6025	0		8.1		0				
Q6026	0		8.0		1.4				
Q6031	0		13.7		0.1				
Q6032	0		0		0.6				

FOR SERVICE MANUALS
CONTACT:
MAURITRON TECHNICAL SERVICES
www.mauritron.co.uk
TEL: 01844 - 351694
FAX: 01844 - 352554

	1	2	3	4	5	6	7	8	9	10	11	12	13	14	15	16	17	18	REMARKS
Q6005	6.2	3.7	2.6	0	2.6	3.7	3.7	7.5											
Q6008	8.1	3.3	0	0	0	0	0	0	0	0	8.0	0	0	0	0	0	0.4	0	
Q6009	2.3	3.3	3.5	4.0	8.0	4.0	4.0	4.0	0										
Q6010	0	2.2	8.0	8.0	8.0	0.4	4.0	4.0	0										
Q6014	6.0	3.6	2.6	0	2.6	3.7	3.7	7.4											
Q6016	7.8	0.4	4.1	4.1	4.4	7.8	0	0	0	0	0	0	0	0	0	0			
Q6023	7.8	3.2	0	7.8	7.8	0	7.8	0	0	7.8	0	0	0	0	0	0	0.4	0	
Q6027	4.9	0	8.1																
Q6028	0	0	8.1	0	0	0	0	0	0	0	0	0	0	0	5.1	7.6			
Q6029	4.9	8.1	3.7	8.0	4.2	0	0.1	0	0	0	0	0	0	4.9	8.1	8.1			
Q6030	4.2	0	0	0	0	0.1	0	0	0.1	0	0	0	4.2	4.9					
Q6033	13.7	0	8.1																
Q7001	0	13.7	8.1	13.6	0														TX

FOR SERVICE MANUALS
CONTACT:
MAURITRON TECHNICAL SERVICES
www.mauritron.co.uk
TEL: 01844 - 351694
FAX: 01844 - 352554

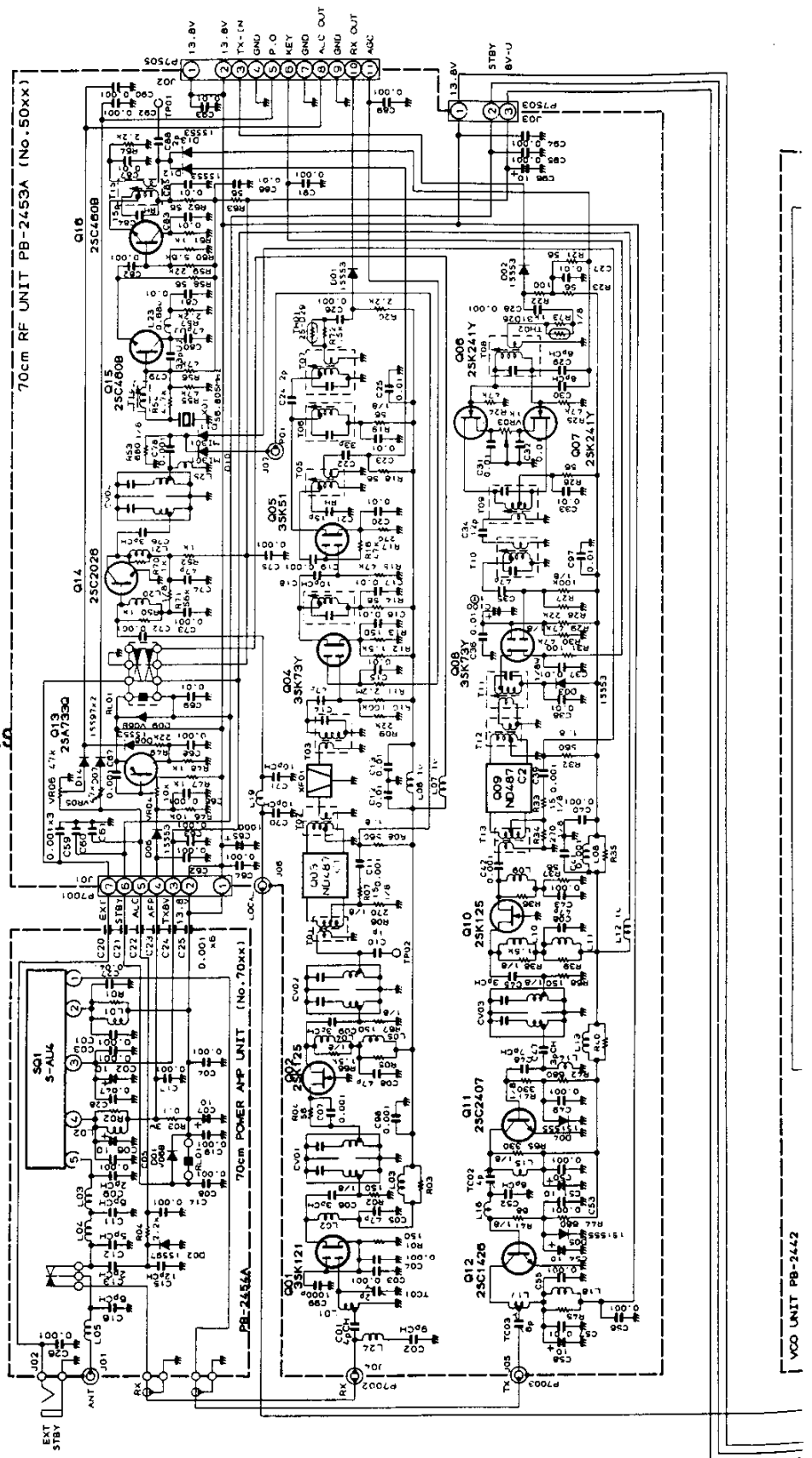

VCO UNIT PB-2442

430 AND 440 MHz MODULES SCHEMATIC DIA

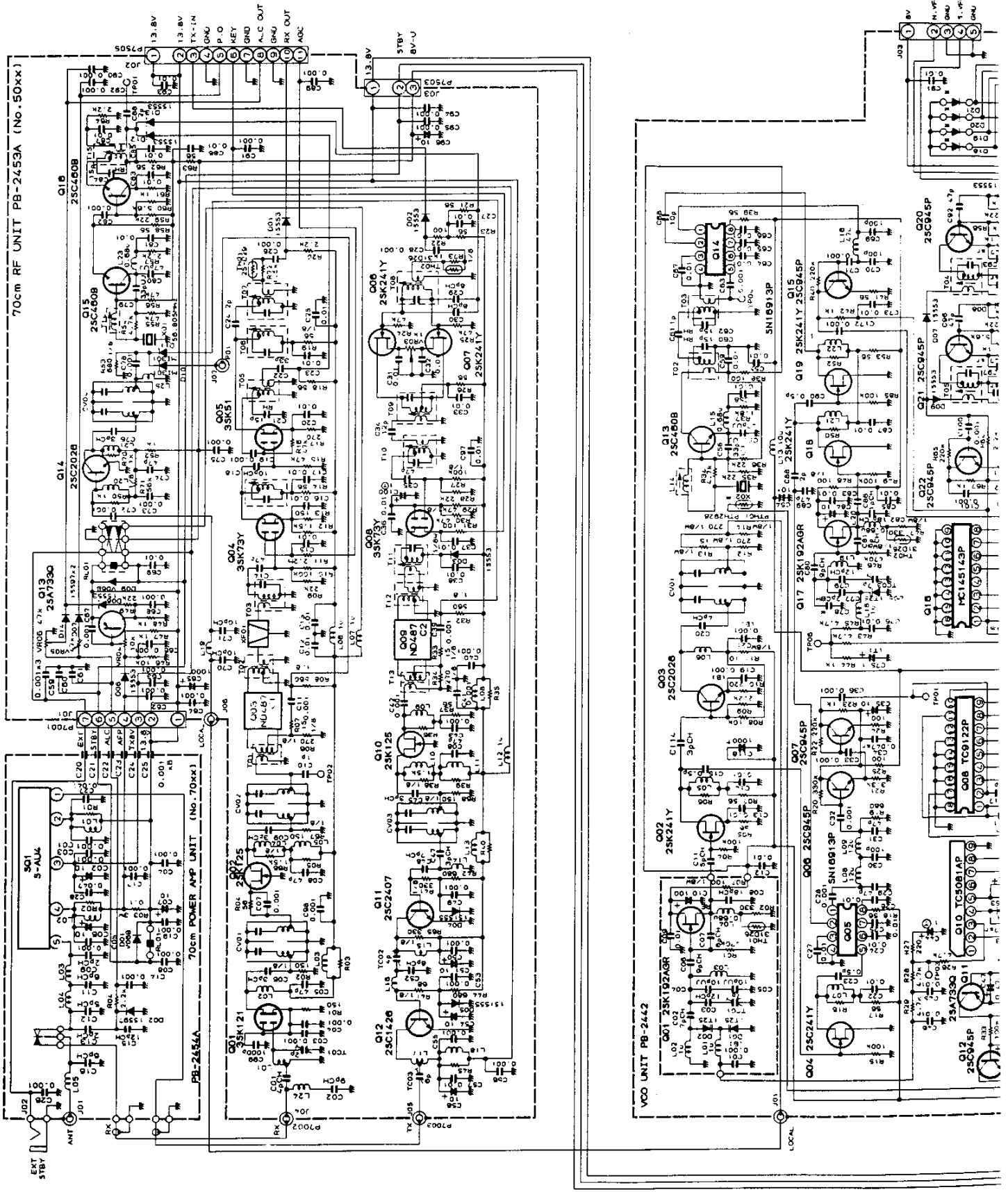

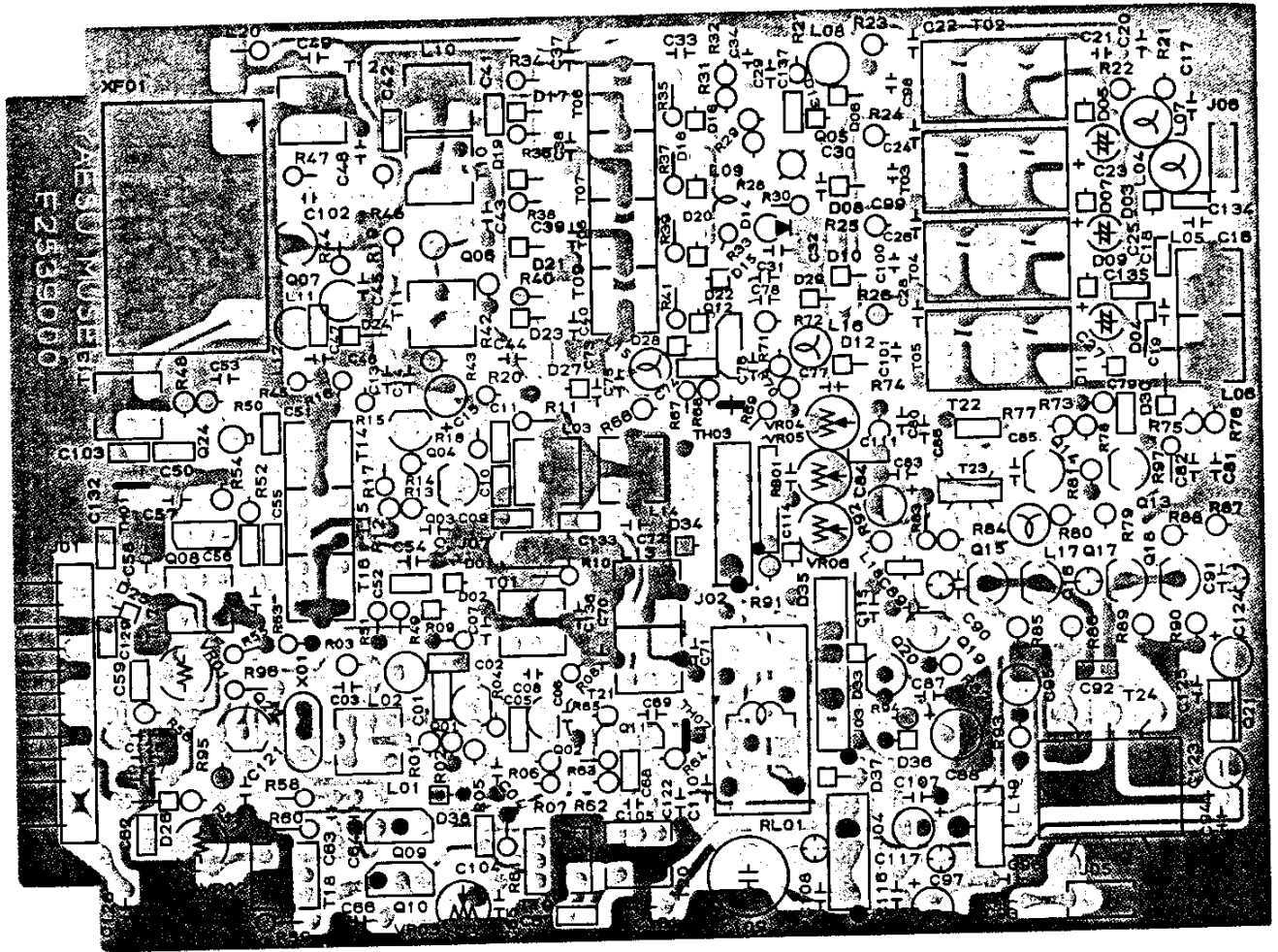

Viewed from component side

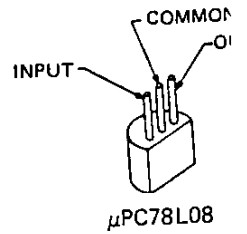
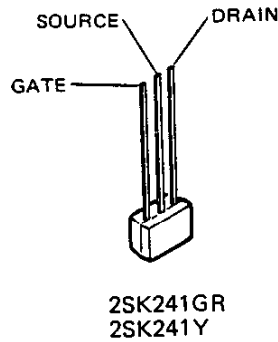
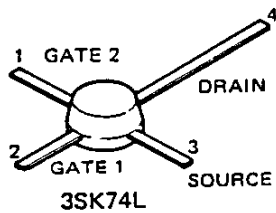
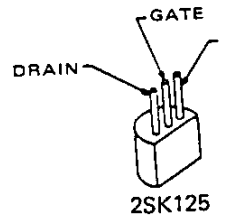
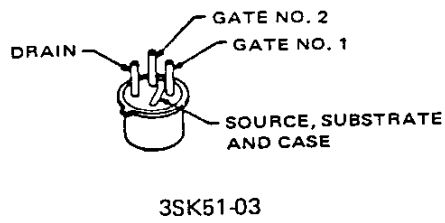
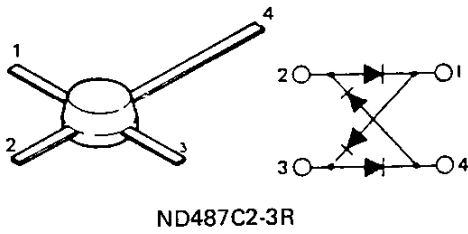

10-15m MODULE: RF UNIT PARTS LAYOUT

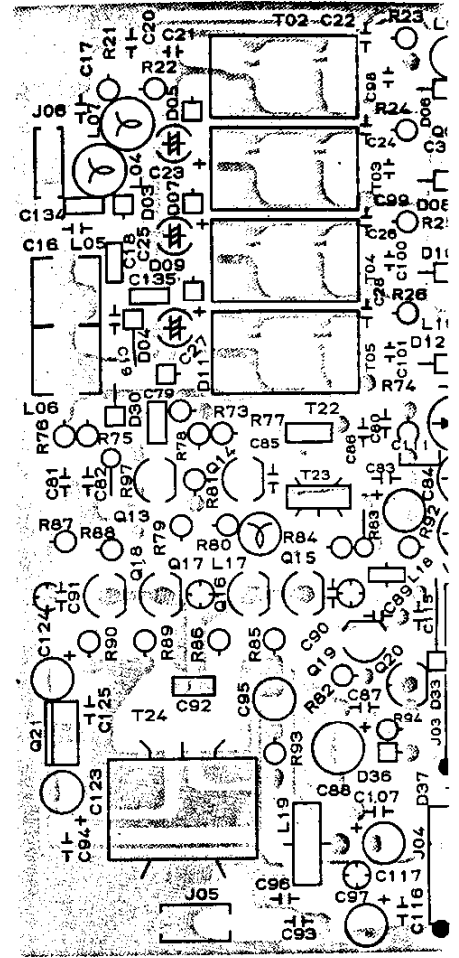
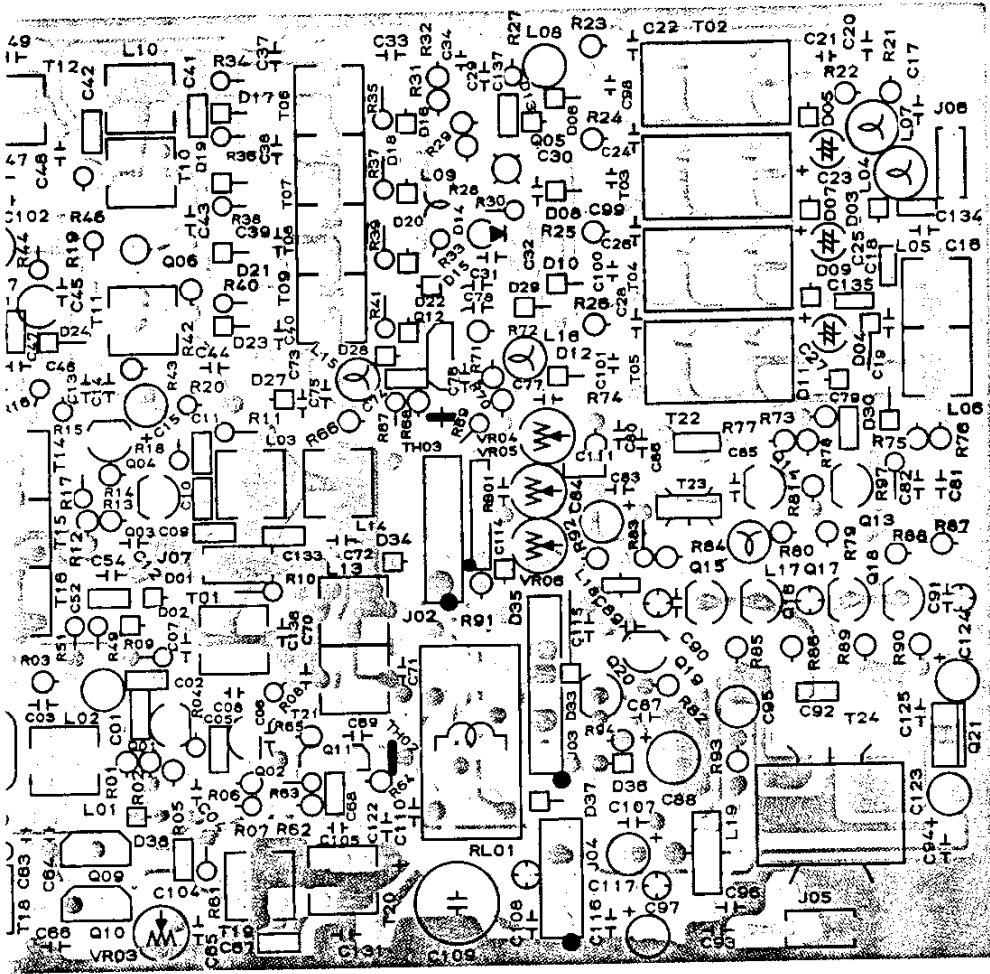

Viewed from component side

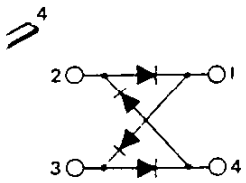

C2-3R

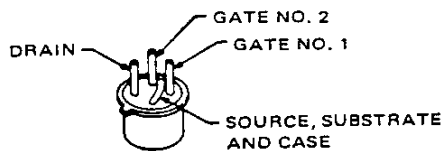

3SK51-03

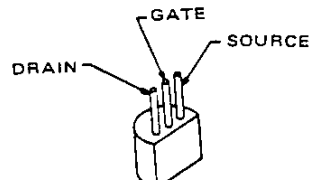

2SK125

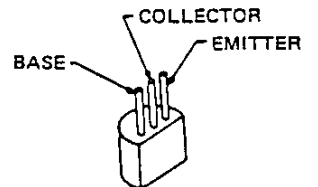

2SA733AQ
2SC460B
2SC535B
2SC1815GR

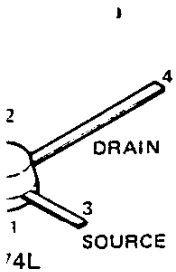

24L

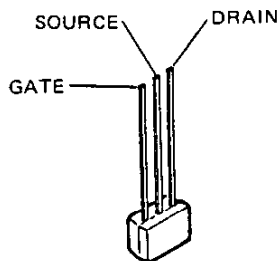

2SK241GR
2SK241Y

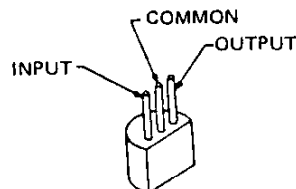

μPC78L08

MODULE: RF UNIT PARTS LAYOUT

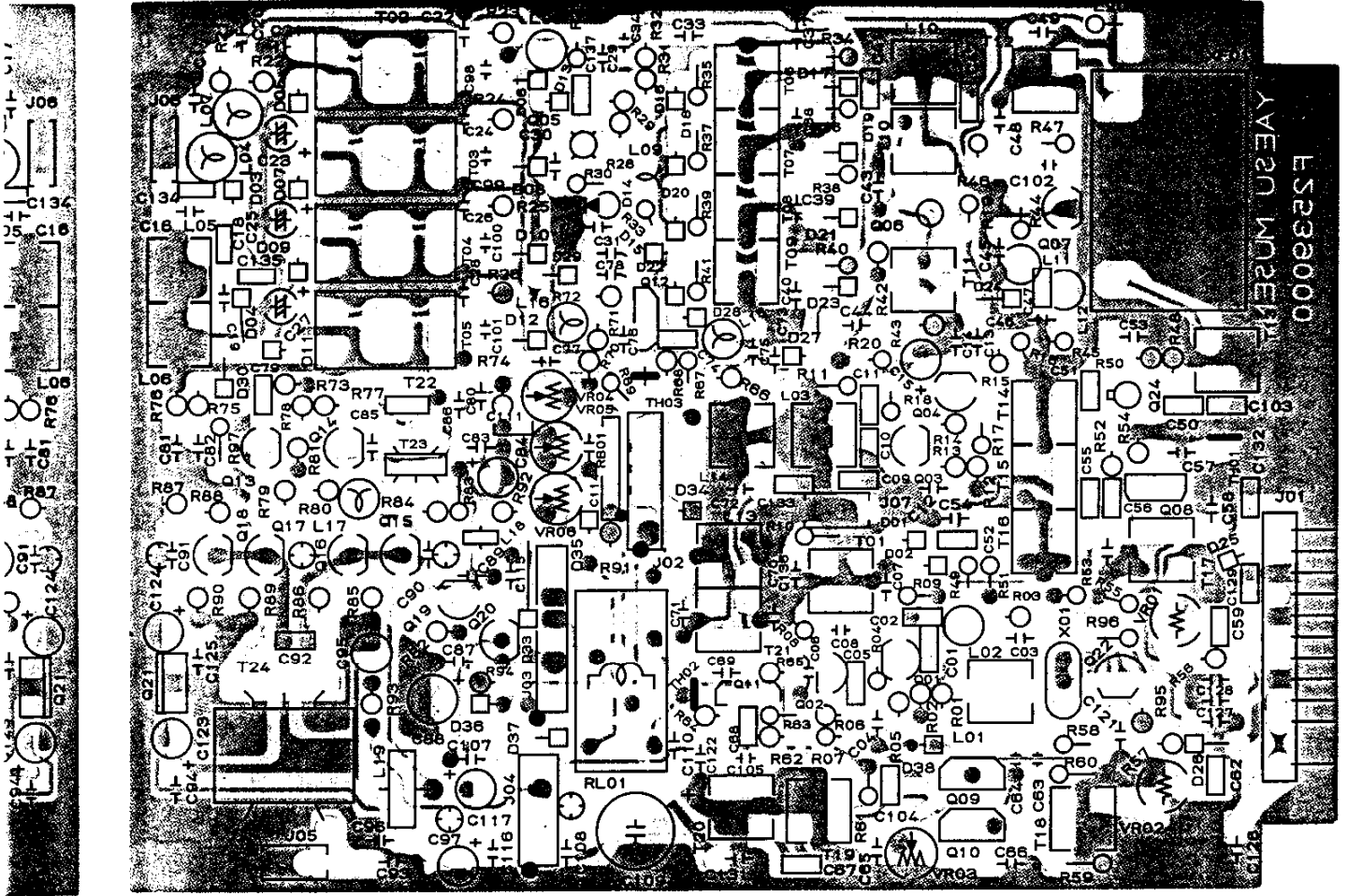

front side

Viewed from solder side

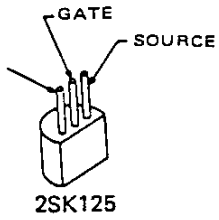

2SK125

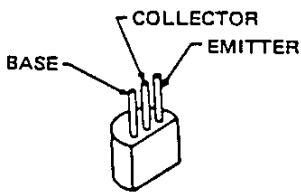

2SA733AQ
2SC460B
2SC535B
2SC1815GR

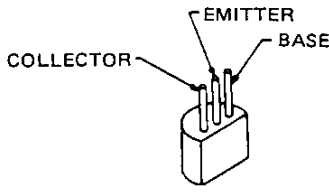

2SC2407

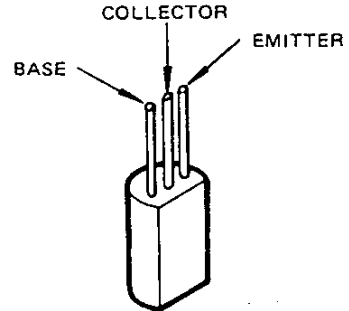

2SC1973

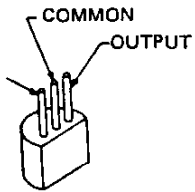

IPC78L08

FOR SERVICE MANUALS
CONTACT:
MAURITRON TECHNICAL SERVICES

www.mauritron.co.uk
TEL: 01844 - 351694
FAX: 01844 - 352554

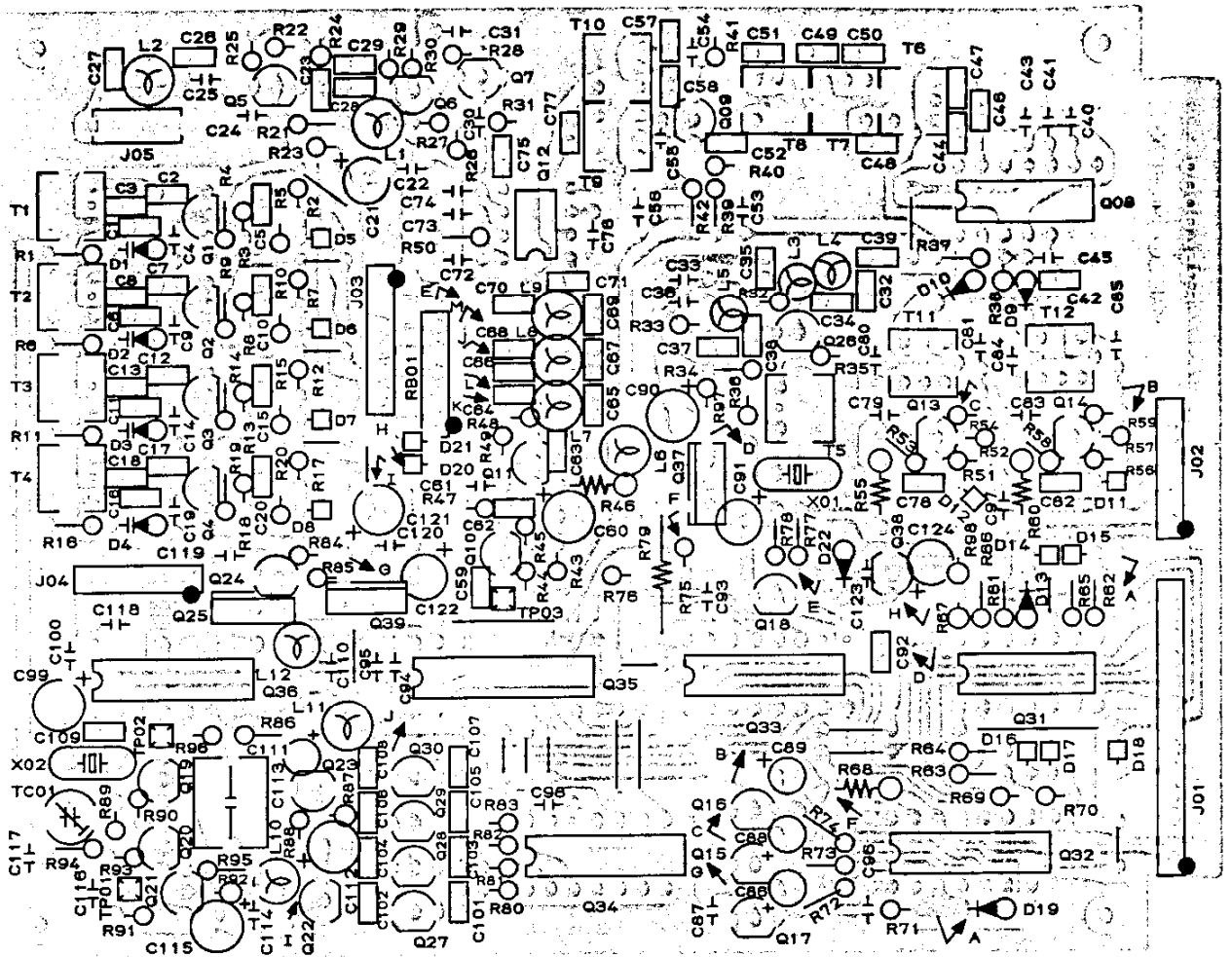

Viewed from component side

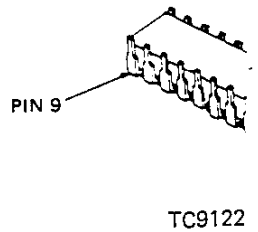
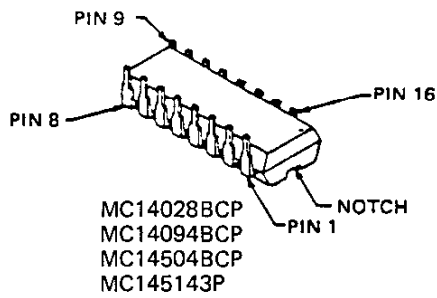
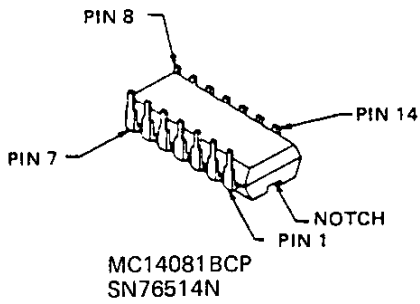

FOR SERVICE MANUALS
CONTACT:
MAURITRON TECHNICAL SERVICES

www.mauritron.co.uk
TEL: 01844 - 351694
FAX: 01844 - 352554

10-15m MODULE: PLL UNIT PARTS LAYO

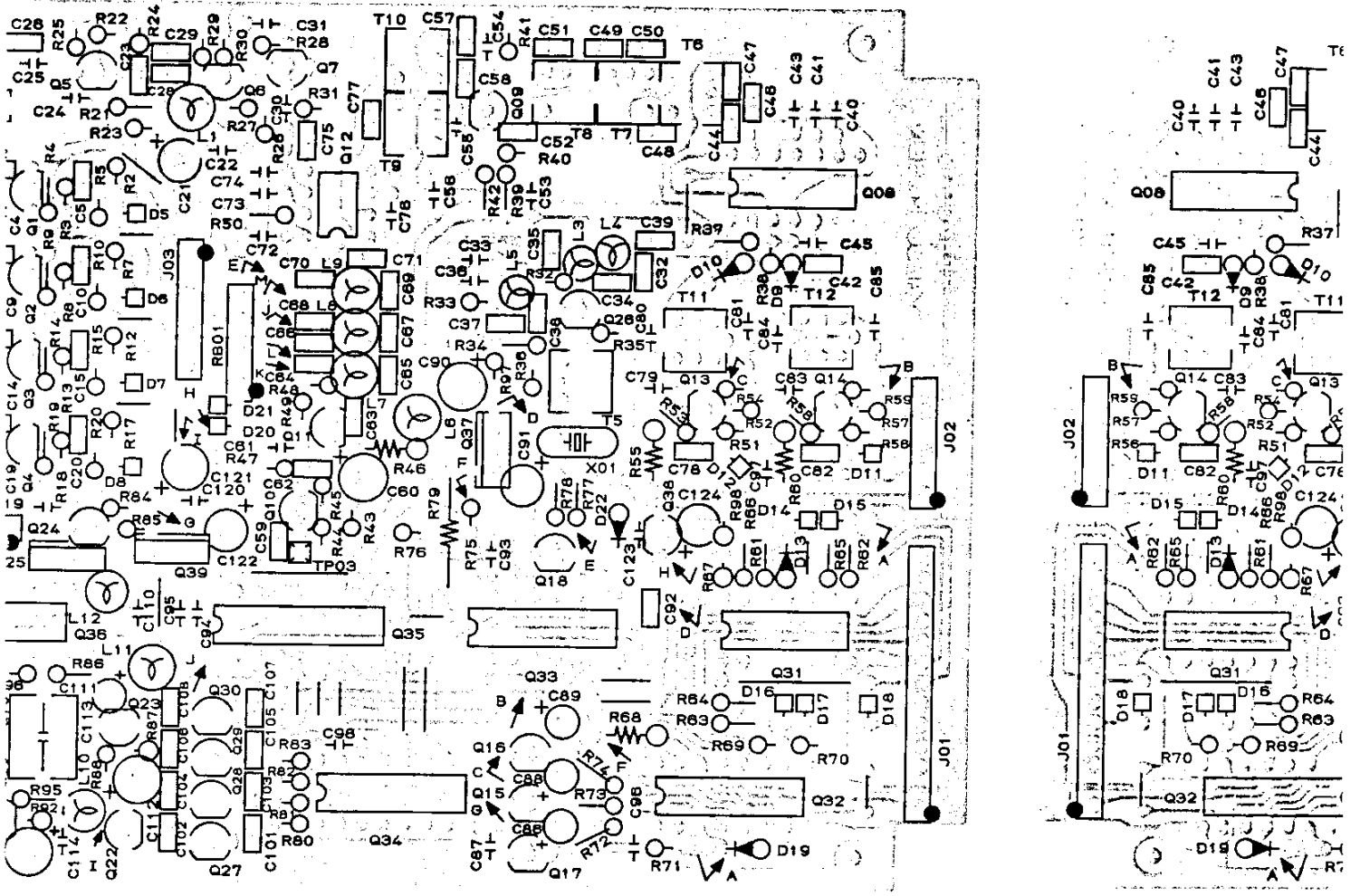

Viewed from component side

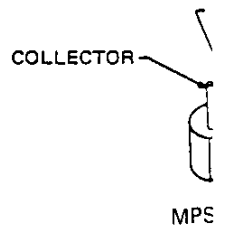
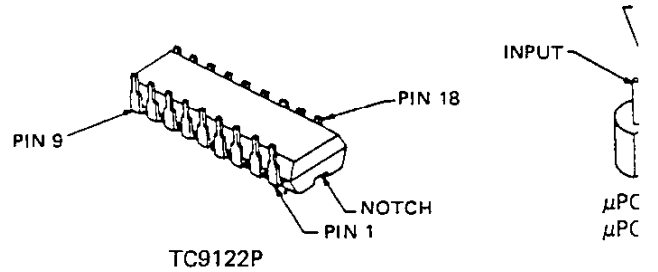
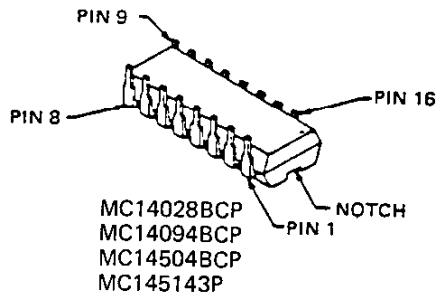
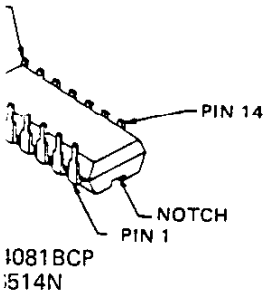

E: PLL UNIT PARTS LAYOUT

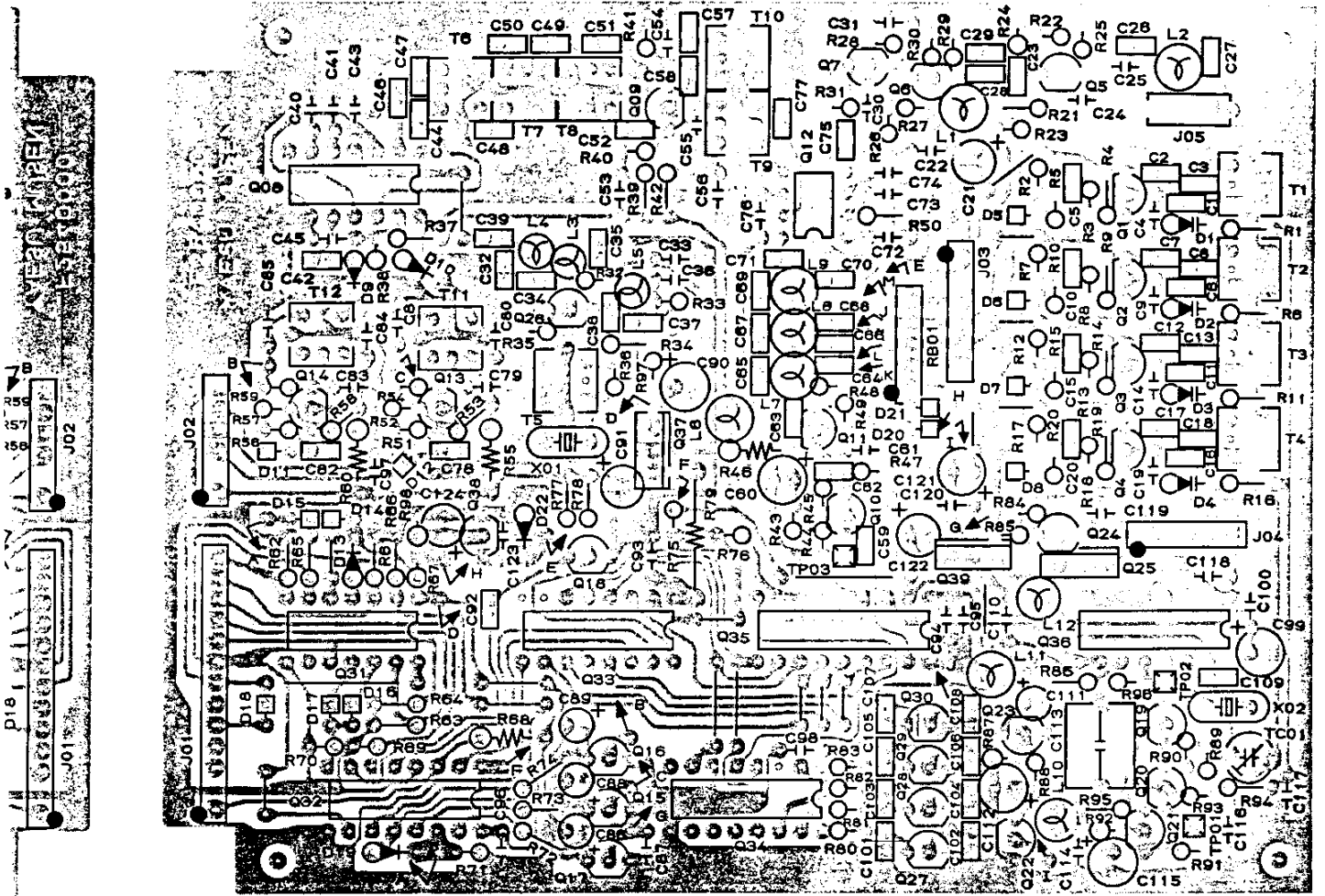

ent side

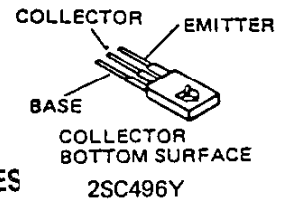
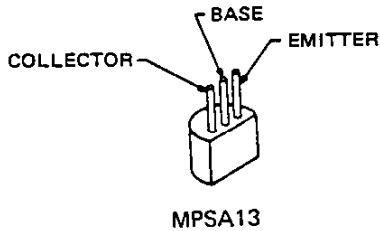
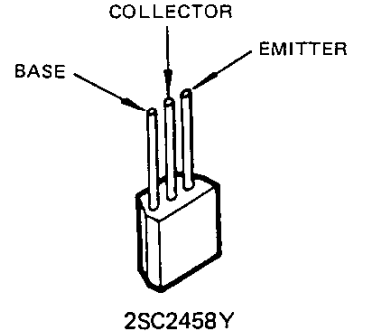
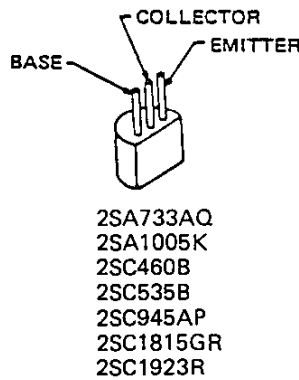
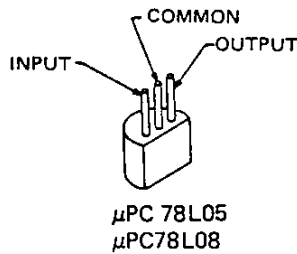
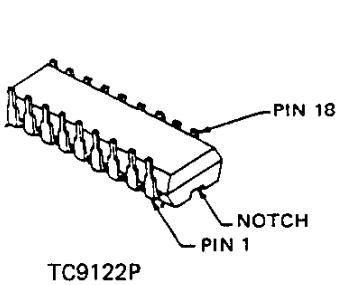

FOR SERVICE MANUALS
CONTACT:
MAURITRON TECHNICAL SERVICES

www.mauritron.co.uk
TEL: 01844 - 351694
FAX: 01844 - 352554

10-15m MODULE: PA UNIT

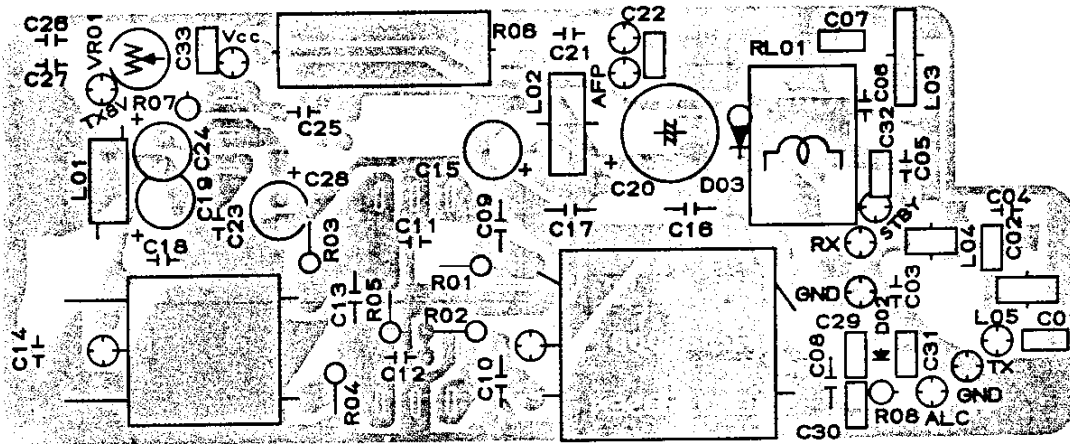

Viewed from component side

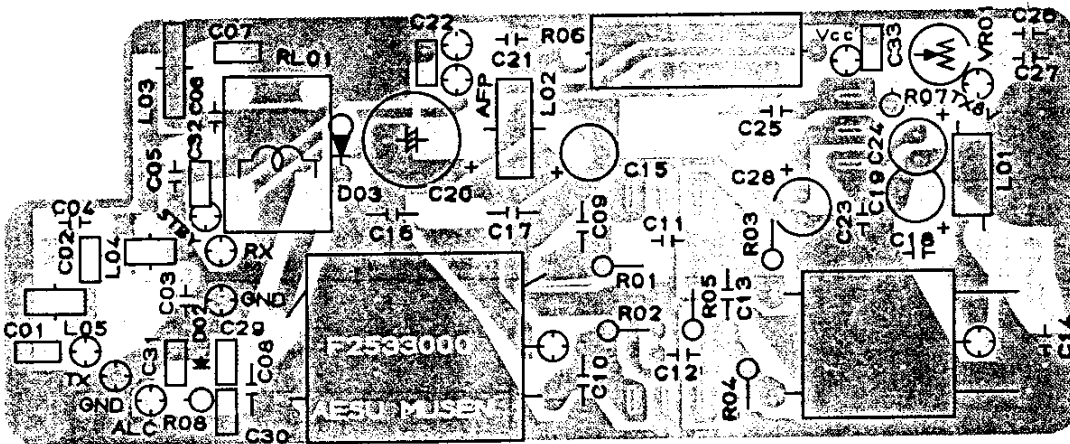

Viewed from solder side

10-15m	
IC	Q
Q5001	3.2
Q5002	0.8
Q5003	1.8
Q5004	6.8
Q5005	1.8
Q5007	1.5
Q0008	0
Q5009	0
Q5010	0
Q5011	0
Q5012	0
Q5013	0
Q5014	0
Q5015	0
Q5016	0
Q5017	0
Q5018	0
Q5019	0
Q5020	13.
Q5022	8.1

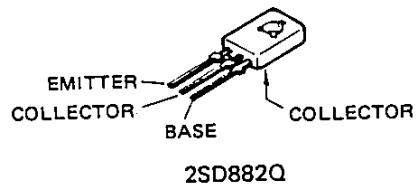
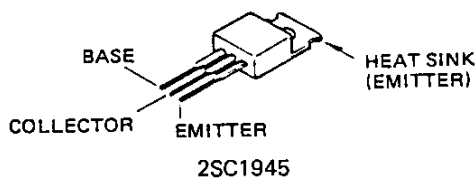

IC	Q
Q5021	13.
Q5023	12.
Q6008	0
Q6012	6.
Q6037	8.
Q6039	13.

FOR SERVICE MANUALS
CONTACT:
MAURITRON TECHNICAL SERVICES

www.mauritron.co.uk
TEL: 01844 - 351694
FAX: 01844 - 352554

10-15m MODULE: PA UNIT PARTS LAYOUT AND VOL

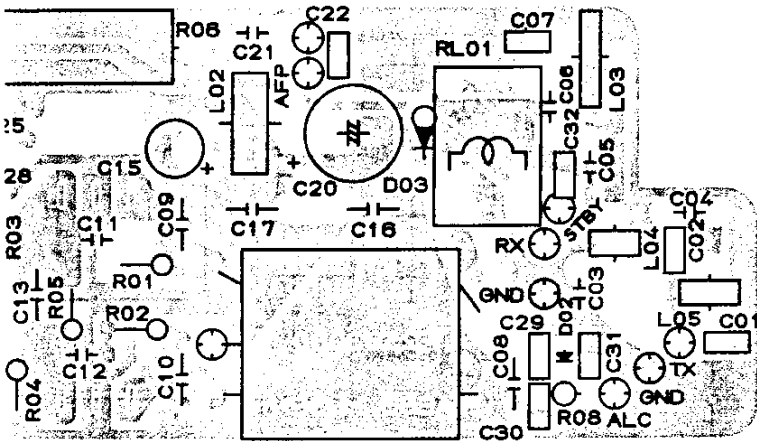

Viewed from component side

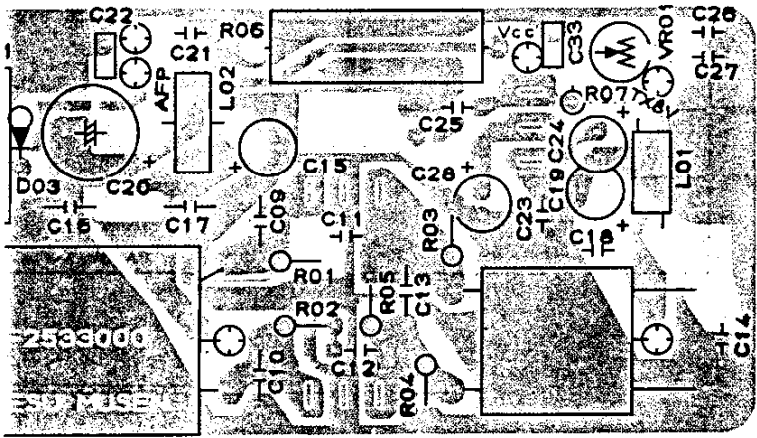

Viewed from solder side

10-15m MODULE VOLTAGE CHART (DC V)

	E(S)		C(D)		B(G1)		(G2)		REM
	R	T	R	T	R	T	R	T	
Q5001	3.3	3.3	8.0	8.0	3.9	3.9			
Q5002	0.8	0.8	7.9	7.9	1.5	1.5			
Q5003	1.8	1.8	6.9	6.9	1.1	1.1			
Q5004	6.8	6.8	10.4	10.4	6.1	6.1			
Q5005	1.8	0	12.3	0	1.4	0	2.3	2.3	
Q5007	1.5	0	11.6	0	0	0			
Q0008	0	0	7.4	0	0	0			
Q5009	0	0.6	0	7.8	0	0			
Q5010	0	0.6	0	7.8	0	0			
Q5011	0	1.4	0	4.4	0	1.4			
Q5012	0	0	0	12.4	0	0.6			
Q5013	0	2.1	0	8.3	0	2.8			
Q5014	0	1.2	0	12.9	0	8.2			
Q5015	0	0	0	12.9	0	0.7			
Q5016	0	0	0	12.9	0	0.7			
Q5017	0	0	0	12.9	0	0.7			
Q5018	0	0	0	12.9	0	0.7			
Q5019	0	0.7	0	8.1	0	1.4			
Q5020	13.8	13.8	0	0	13.8	13.8			
Q5022	8.1	8.1	8.0	0	7.4	8.1			

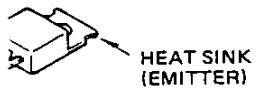

TER
:1945

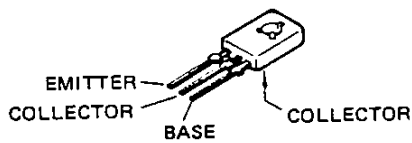

2SD882Q

IC	1	2	3	4	5	6	7	8	9
Q5021	13.0	0	8.1						
Q5023	12.9	0	8.0						
Q6008	0	7.8	7.0	4.1	2.3	0	0	0	2.3
Q6012	6.3	3.8	2.7	0	2.7	3.8	3.8	7.6	
Q6037	8.1	0	5.0						
Q6039	13.1	0	8.2						

A UNIT PARTS LAYOUT AND VOLTAGE CHARTS

10-15m MODULE VOLTAGE CHART (DC VOLTS)

	E(S)		C(D)		B(G1)		(G2)		REMARKS
	R	T	R	T	R	T	R	T	
Q5001	3.3	3.3	8.0	8.0	3.9	3.9			
Q5002	0.8	0.8	7.9	7.9	1.5	1.5			
Q5003	1.8	1.8	6.9	6.9	1.1	1.1			
Q5004	6.8	6.8	10.4	10.4	6.1	6.1			
Q5005	1.8	0	12.3	0	1.4	0	2.3	2.3	
Q5007	1.5	0	11.6	0	0	0			
Q0008	0	0	7.4	0	0	0			
Q5009	0	0.6	0	7.8	0	0			
Q5010	0	0.6	0	7.8	0	0			
Q5011	0	1.4	0	4.4	0	1.4			
Q5012	0	0	0	12.4	0	0.6			
Q5013	0	2.1	0	8.3	0	2.8			
Q5014	0	1.2	0	12.9	0	8.2			
Q5015	0	0	0	12.9	0	0.7			
Q5016	0	0	0	12.9	0	0.7			
Q5017	0	0	0	12.9	0	0.7			
Q5018	0	0	0	12.9	0	0.7			
Q5019	0	0.7	0	8.1	0	1.4			
Q5020	13.8	13.8	0	0	13.8	13.8			
Q5022	8.1	8.1	8.0	0	7.4	8.1			

Q6001	4.3	4.3	0.7	0.7	3.4	3.4			28.0 MHz
Q6002	4.3	4.3	0.7	0.7	3.7	3.7			26.0 MHz
Q6003	4.4	4.4	0.6	0.6	3.7	3.7			24.5 MHz
Q6004	4.3	4.3	0.7	0.7	3.8	3.8			21.0 MHz
Q6005	4.4	4.4	7.2	7.2	5.2	5.2			
Q6006	1.0	1.0	3.6	3.6	1.0	1.0			
Q6007	3.0	3.0	6.6	6.6	3.6	3.6			
Q6009	0.9	0.9	8.0	8.0	1.7	1.7			
Q6010	0.2	0.2	4.5	4.5	0.9	0.9			
Q6011	3.2	3.2	7.8	7.8	3.0	3.0			
Q6013	1.1	1.1	8.0	8.0	1.7	1.7			SAT
Q6014	1.1	1.1	8.0	8.0	1.7	1.7			SAT
Q6015	0	0	0	0	0.7	0.7			
Q6016	0	0	0	0	0.7	0.7			
Q6017	0	0	0	0	0.7	0.7			
Q6018	0	0	0	0	0.6	0.6			
Q6019	1.4	1.4	8.0	8.0	1.8	1.8			21.0 MHz
Q6020	0.9	0.9	3.6	3.6	1.3	1.3			21.0 MHz
Q6021	0.2	0.2	3.6	3.6	0.9	0.9			21.0 MHz
Q6022	0	0	0	1.3	0	0			
Q6023	8.2	8.2	0	0	8.0	8.0			21.0 MHz
Q6024	13.7	13.7	13.7	13.7	13.1	13.1			
Q6025	13.1	13.1	13.7	13.7	13.7	13.7			
Q6026	1.7	1.7	4.9	4.9	2.4	2.4			
Q6027	0	0	0	0	0.8	0.8			28.0 MHz
Q6028	0	0	0	0	0.8	0.8			24.5 MHz
Q6029	0	0	0	0	0.8	0.8			21.0 MHz
Q6030	0	0	0	0	0.8	0.8			26.0 MHz
Q6038	0	0	13.4	0.8	0	1.4			
Q7001	0	0.1	0	8.0	0	0.6			SSB
Q7002	0	0	13.8	13.8	0	0.1			
Q7003	0	0	13.8	13.8	0	0.1			

IC	1	2	3	4	5	6	7	8	9	10	11	12	13	14	REMARKS
Q5021	13.0	0	8.1												
Q5023	12.9	0	8.0												TX
Q6008	0	7.8	7.0	4.1	2.3	0	0	0	2.3	4.0	4.0	4.0	6.9	0	
Q6012	6.3	3.8	2.7	0	2.7	3.8	3.8	7.6							
Q6037	8.1	0	5.0												
Q6039	13.1	0	8.2												

FOR SERVICE MANUALS
CONTACT:
MAURITRON TECHNICAL SERVICES
www.mauritron.co.uk
TEL: 01844 - 351694
FAX: 01844 - 352554

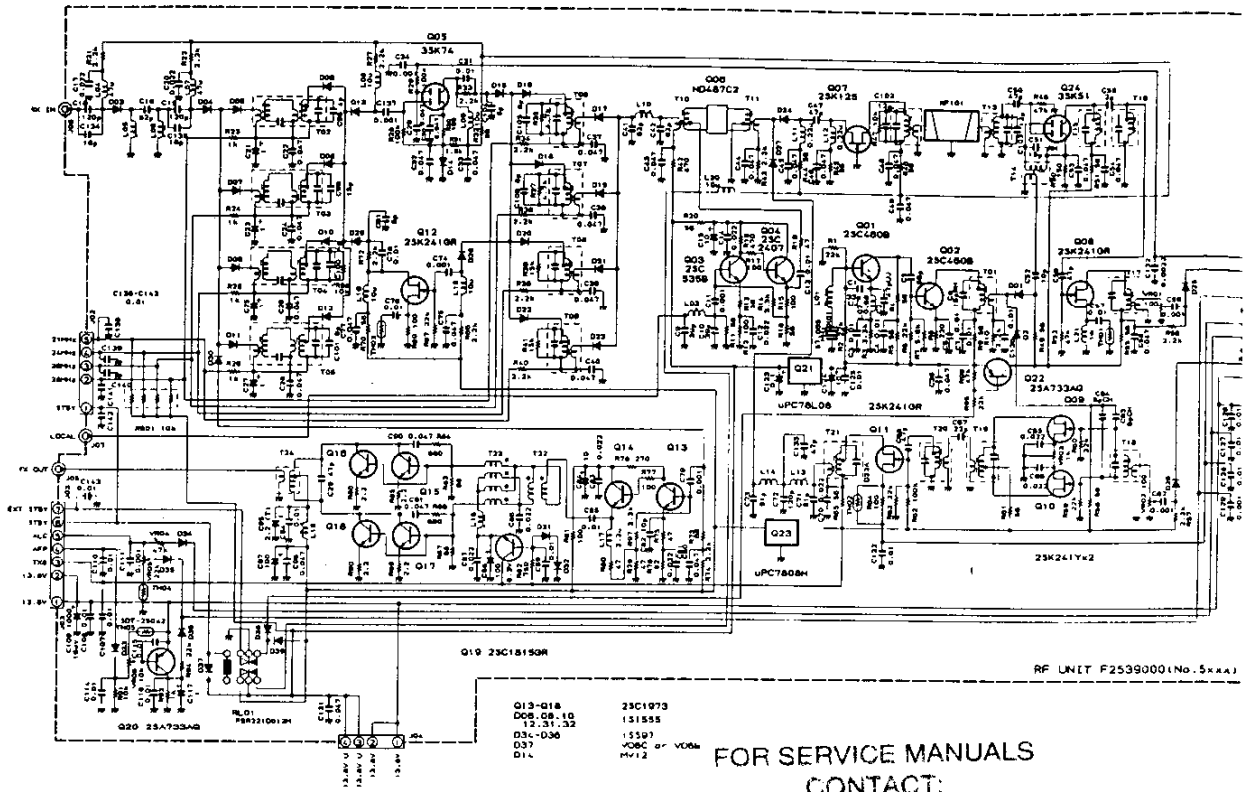

FOR SERVICE MANUALS
 CONTACT:
MAURITRON TECHNICAL SERVICES
www.mauritron.co.uk
 TEL: 01844 - 351694
 FAX: 01844 - 352554

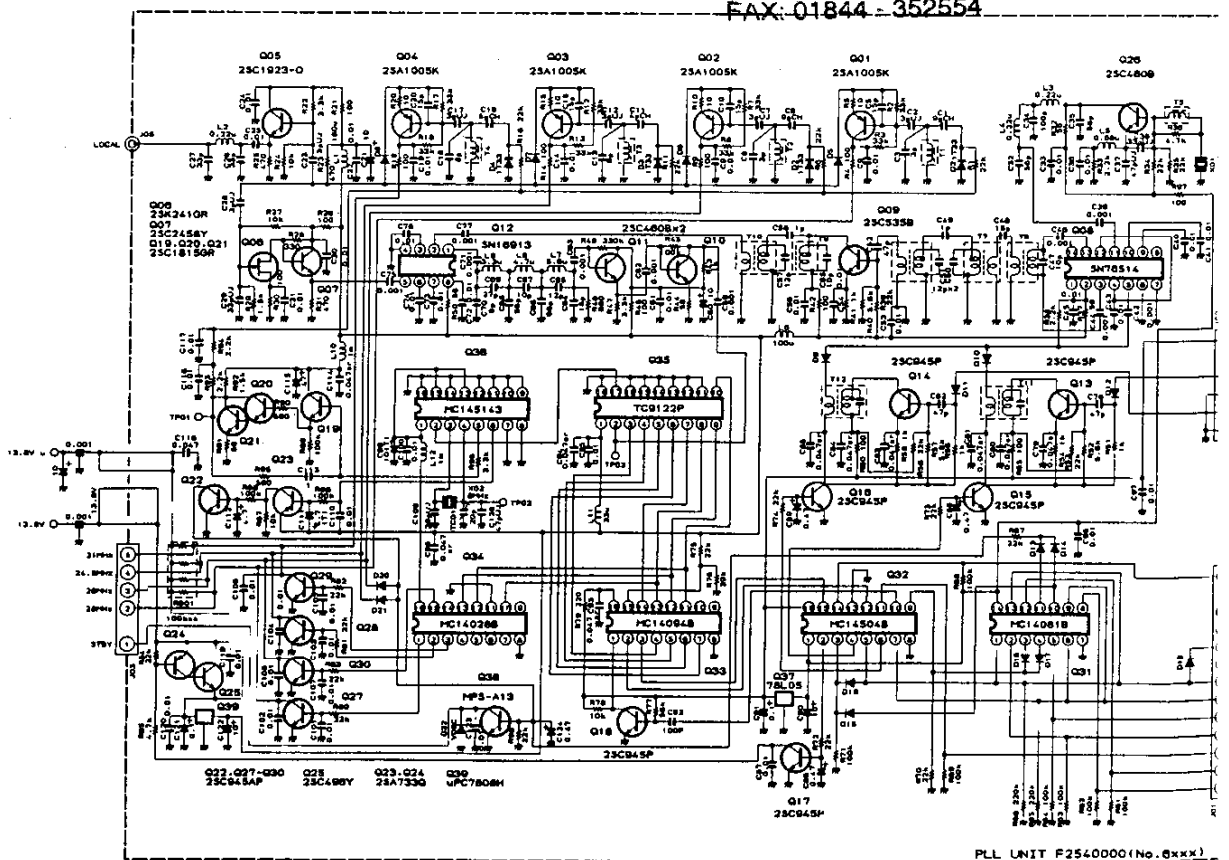

10-15m MODULE SCHEMATIC DIAGRAM

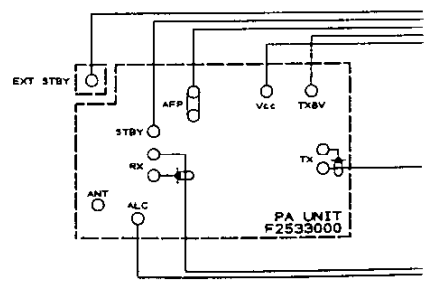
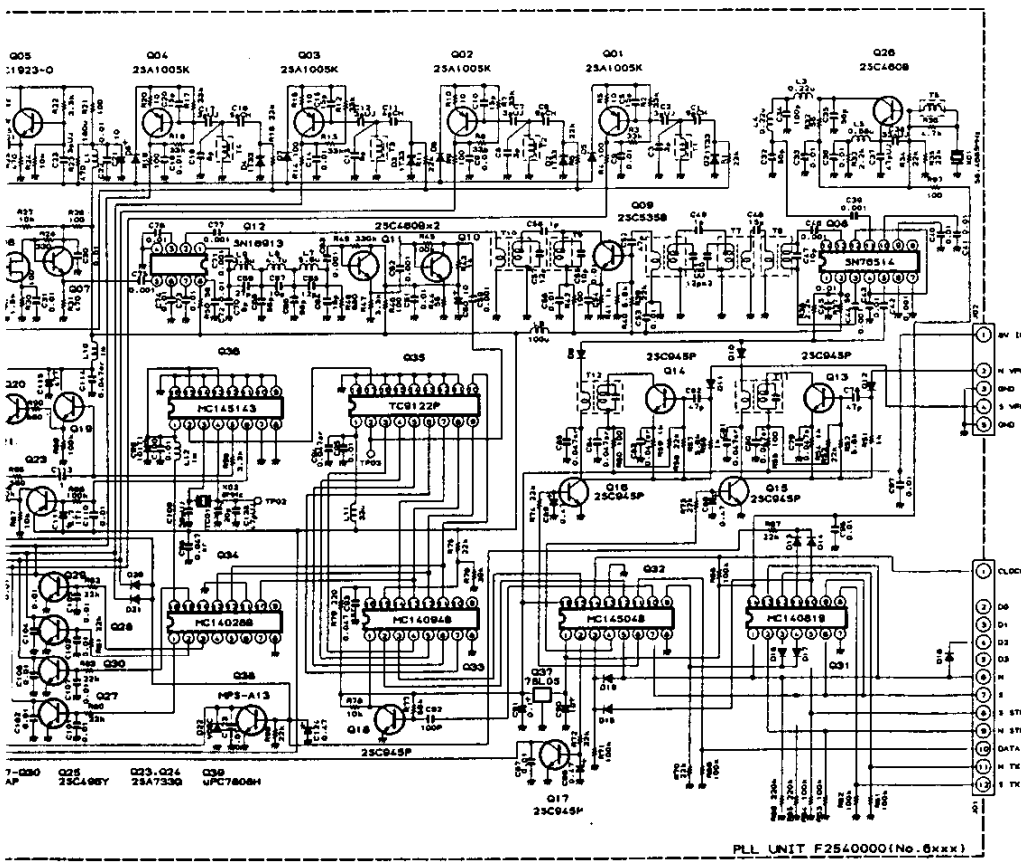
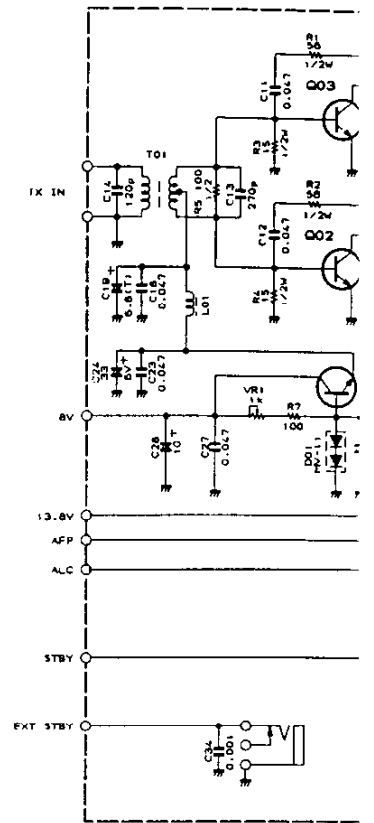
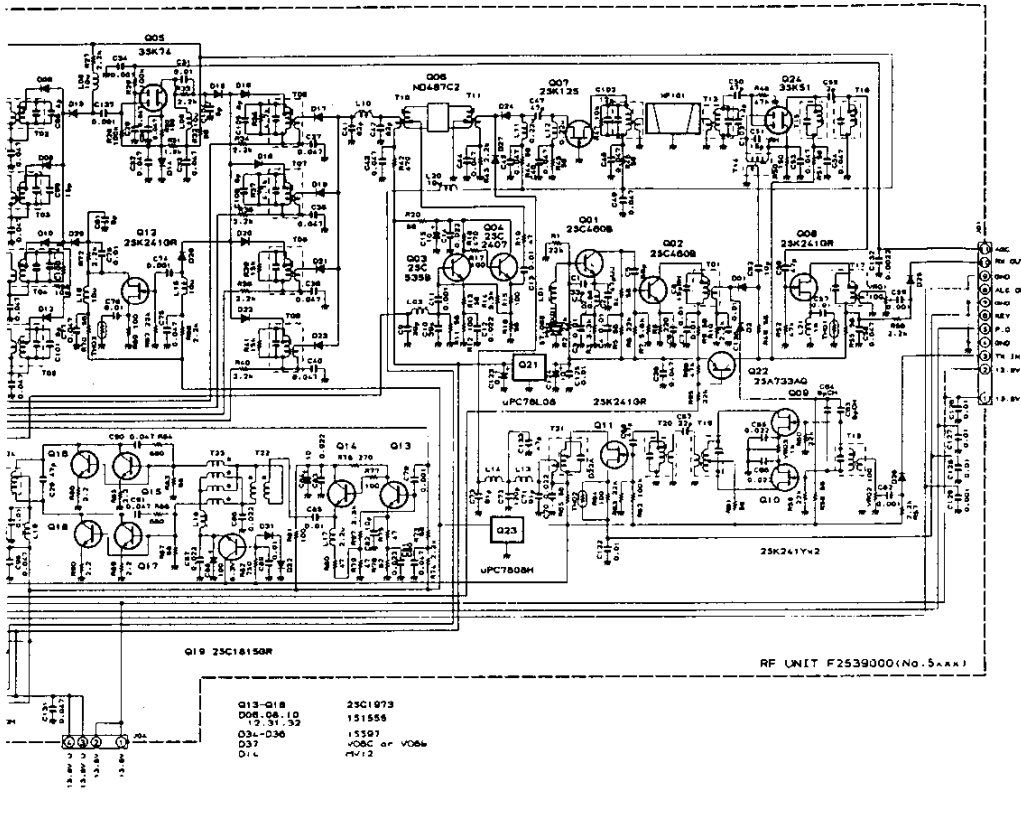

FILE SCHEMATIC DIAGRAM

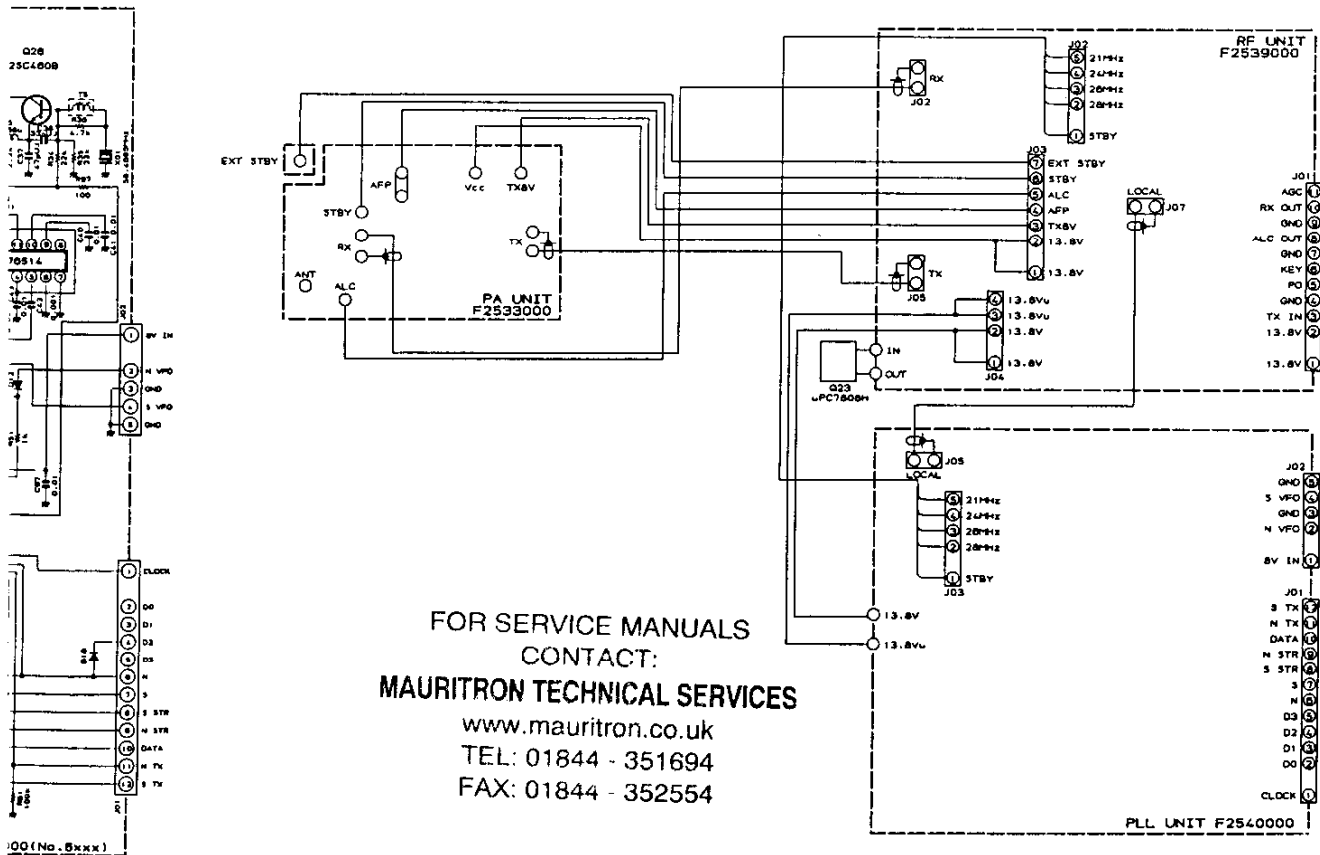
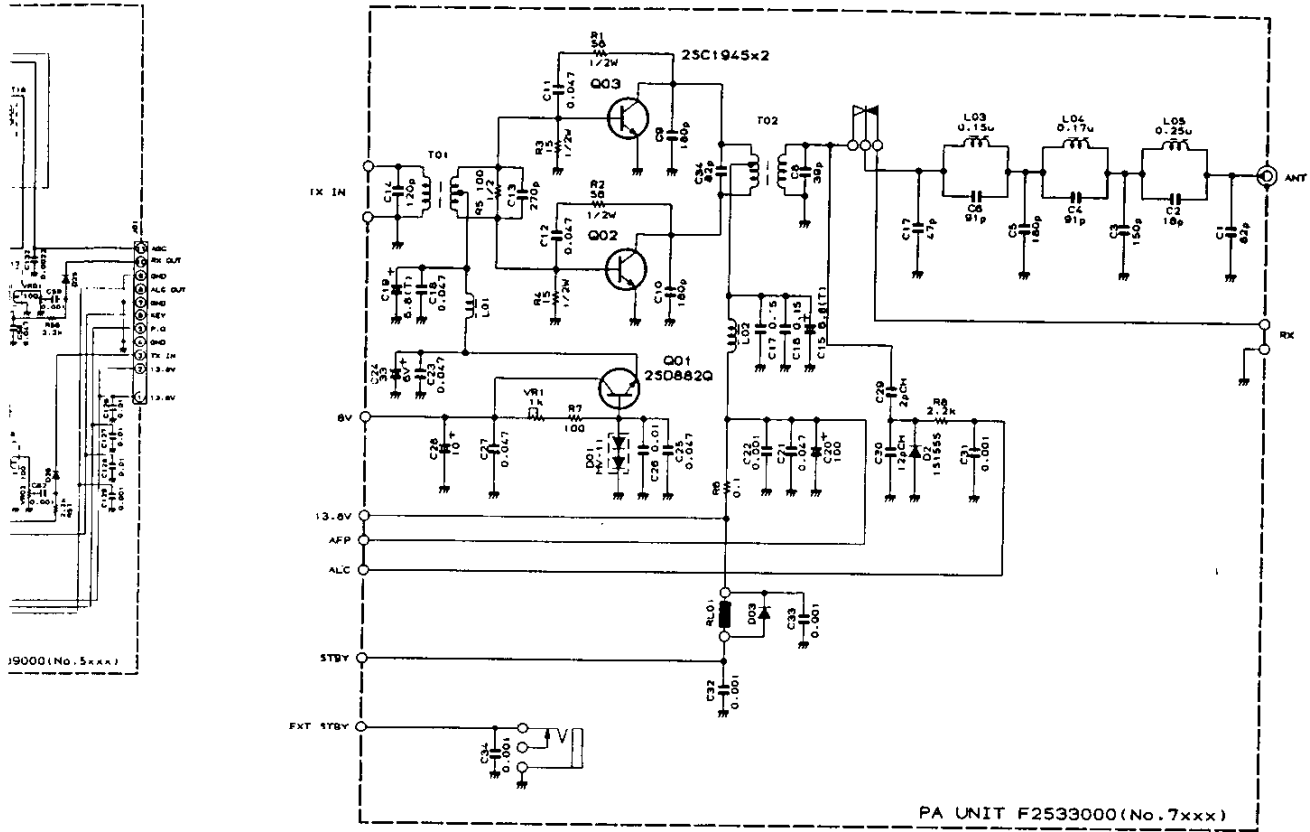

FT726 10-15m UNIT CONNECTION DIAGRAM

INTERCONNEC

FOR SERVICE MANUALS

CONTACT:

MAURITRON TECHNICAL SERVICES

www.mauritron.co.uk

TEL: 01844 - 351694

FAX: 01844 - 352554

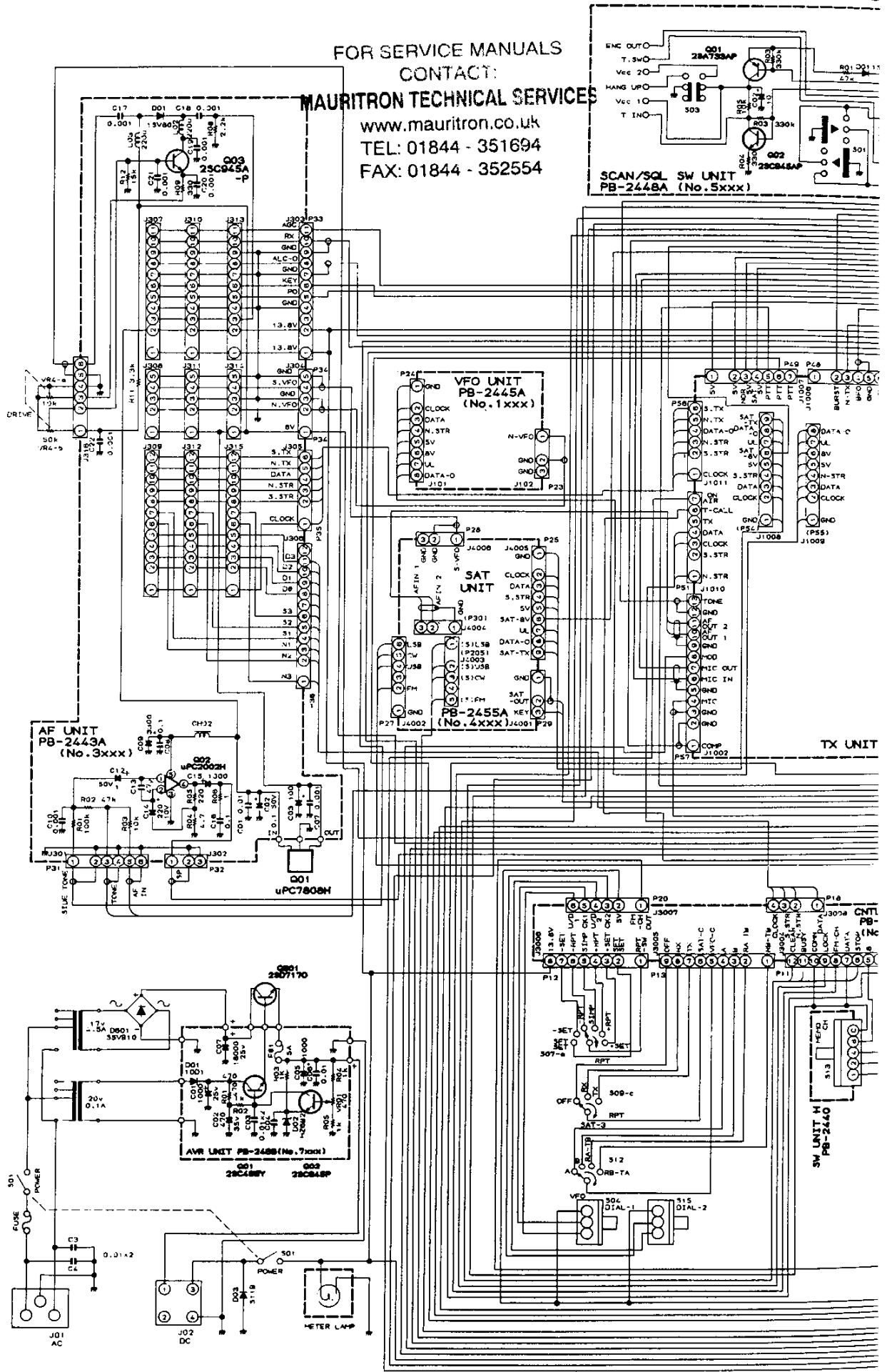

SCAN/SQL SW UNIT
PB-2448A (No. 5xxx)

AF UNIT
PB-2443A
(No. 3xxx)

VFO UNIT
PB-2445A
(No. 1xxx)

SAT
UNIT
PB-2455A
(No. 4xxx)

TX UNIT

AVR UNIT PB-2408 (No. 7xxx)

SW UNIT H
PB-2440

INTERCONNECTION DIAGRAM

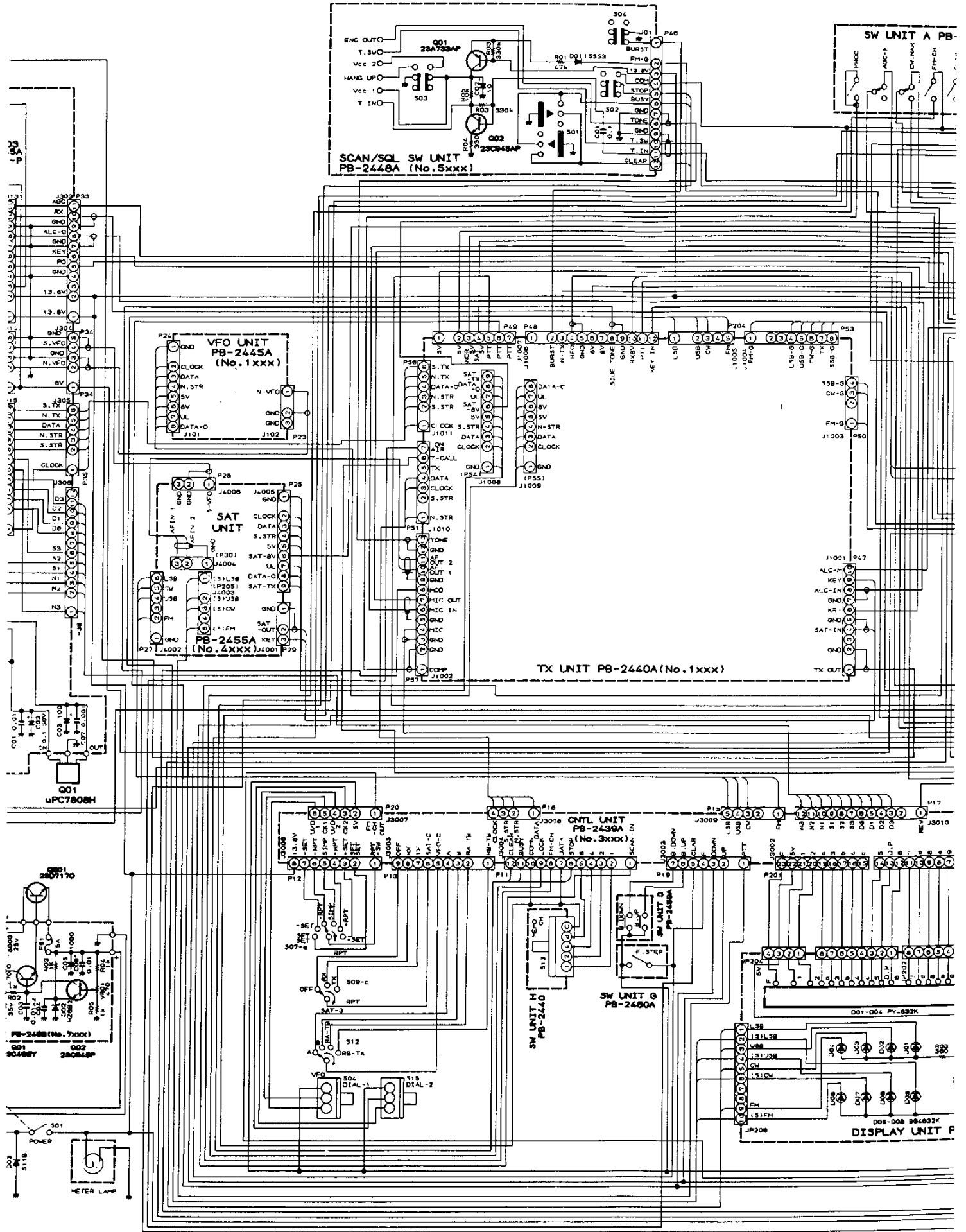

SECTION DIAGRAM

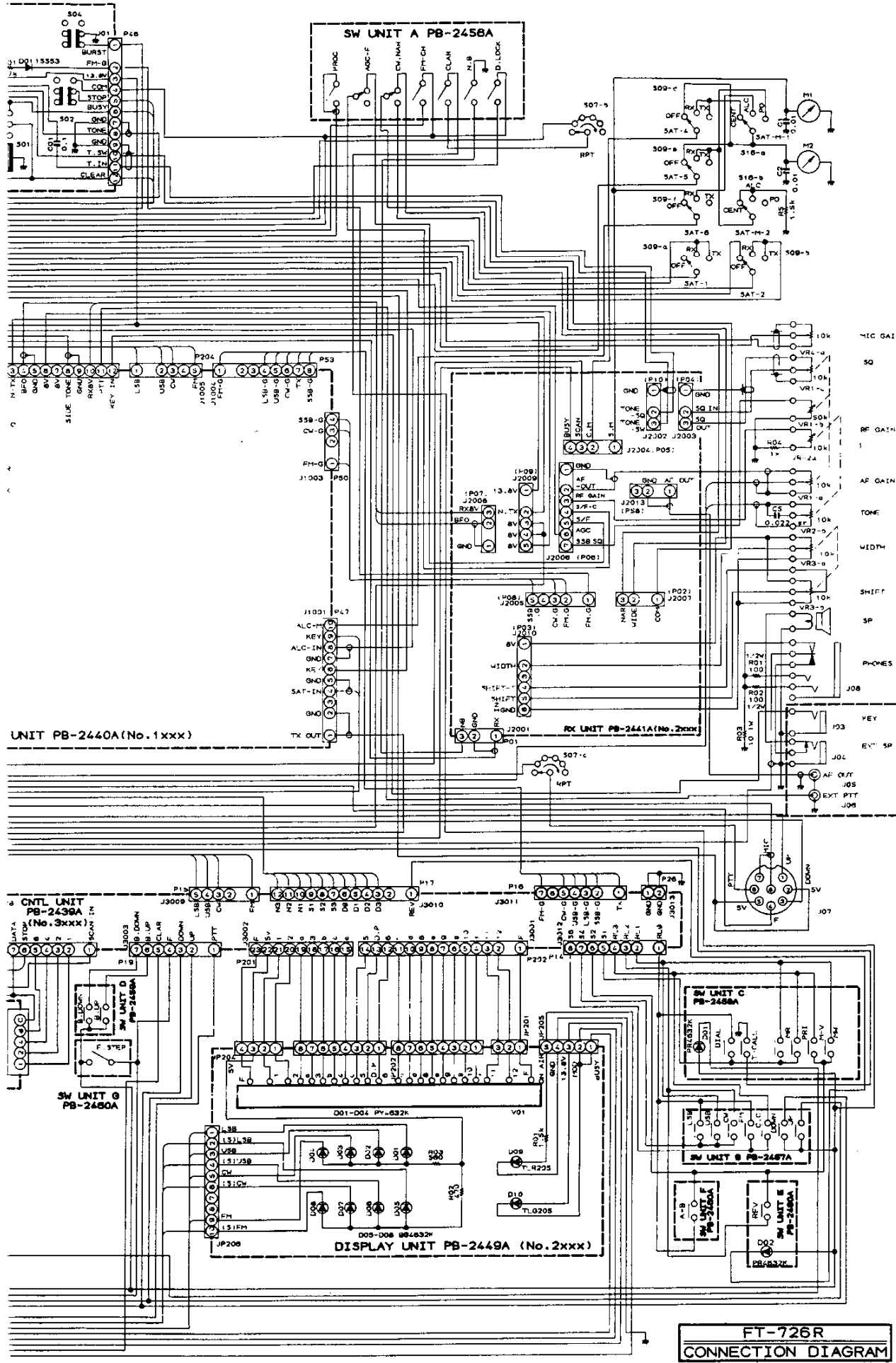

**FT-726R
CONNECTION DIAGRAM**

FOR SERVICE MANUALS
CONTACT:
MAURITRON TECHNICAL SERVICES
www.mauritron.co.uk
TEL: 01844 - 351694
FAX: 01844 - 352554

BLOCK

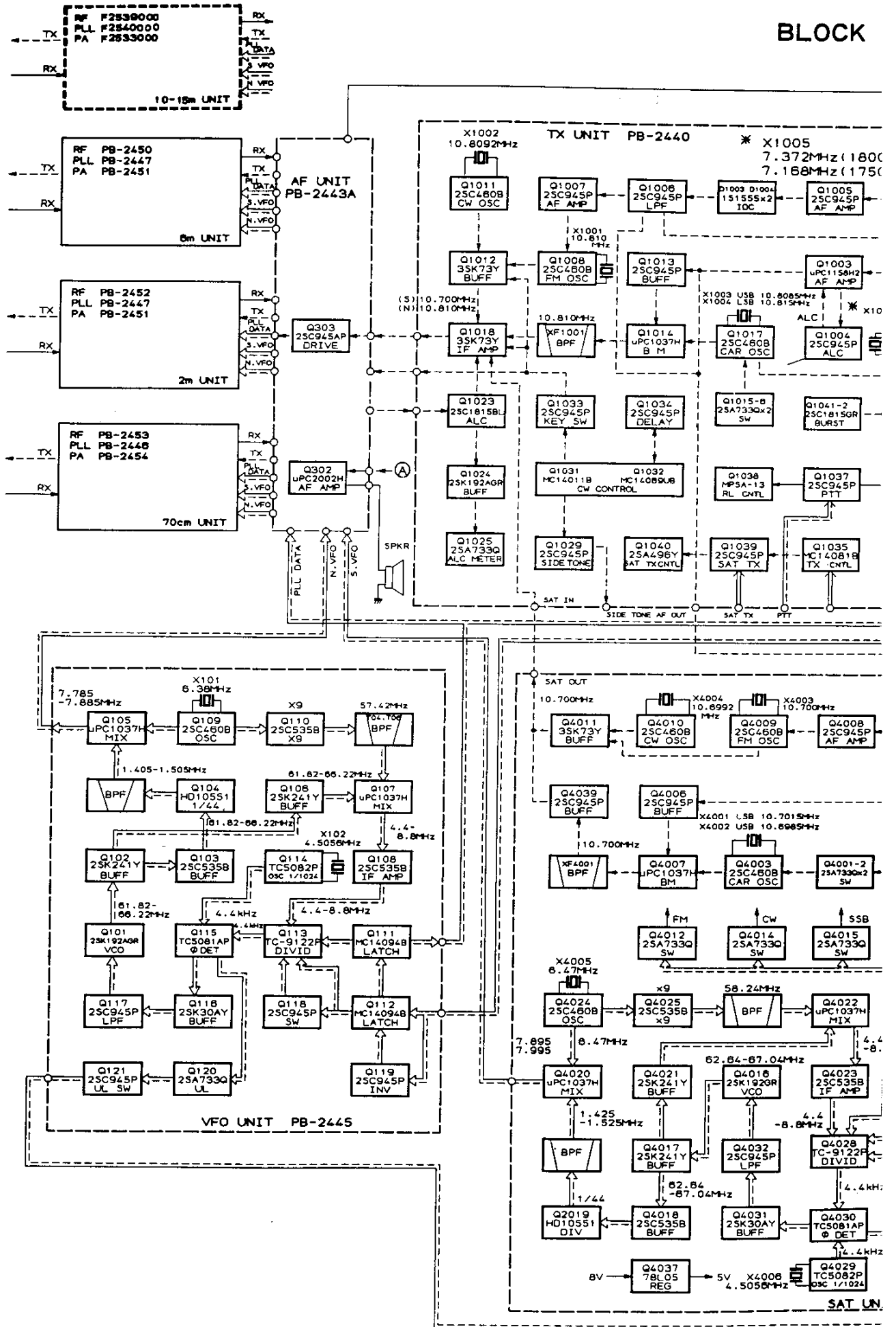

BLOCK DIAGRAM

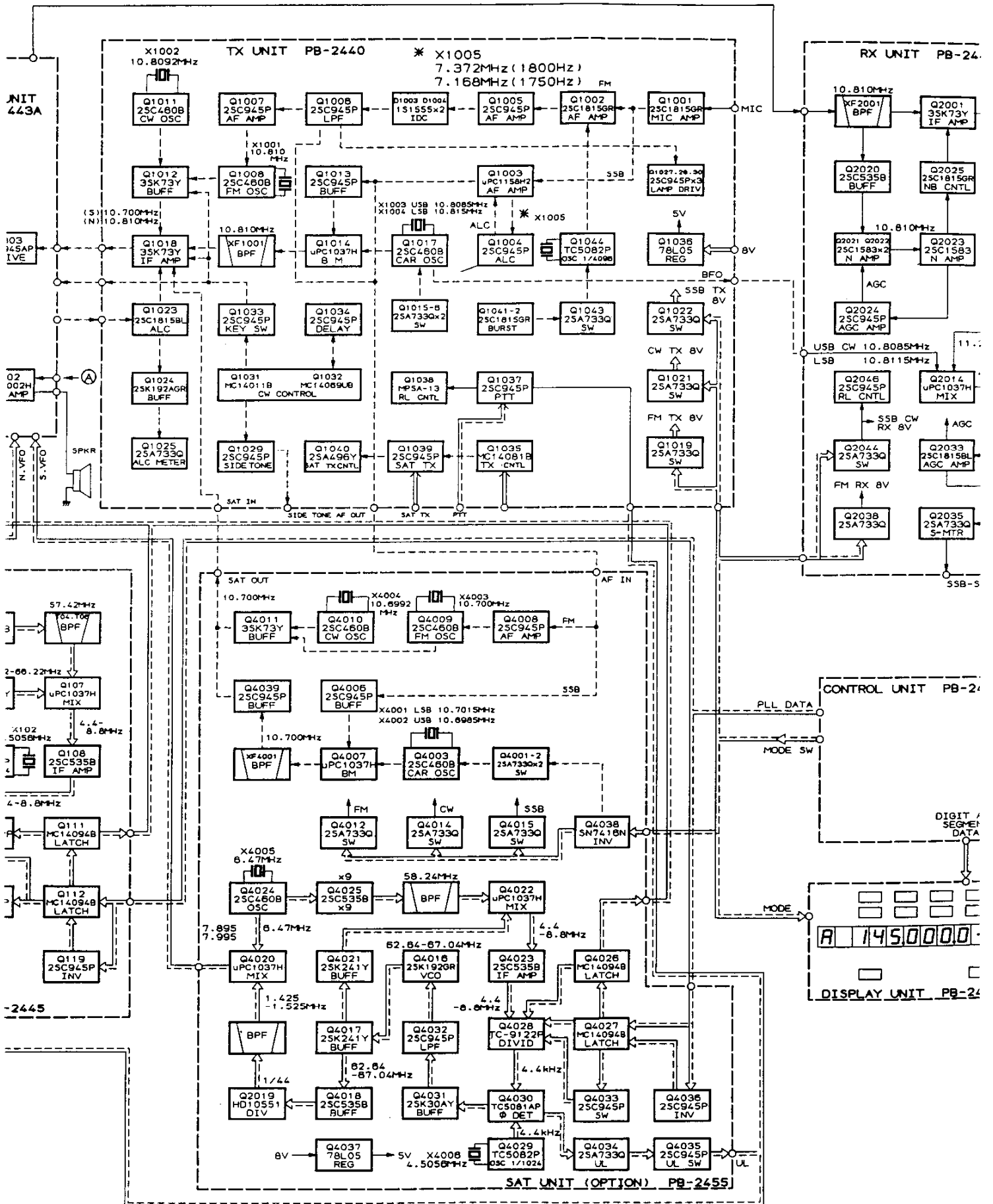

K DIAGRAM

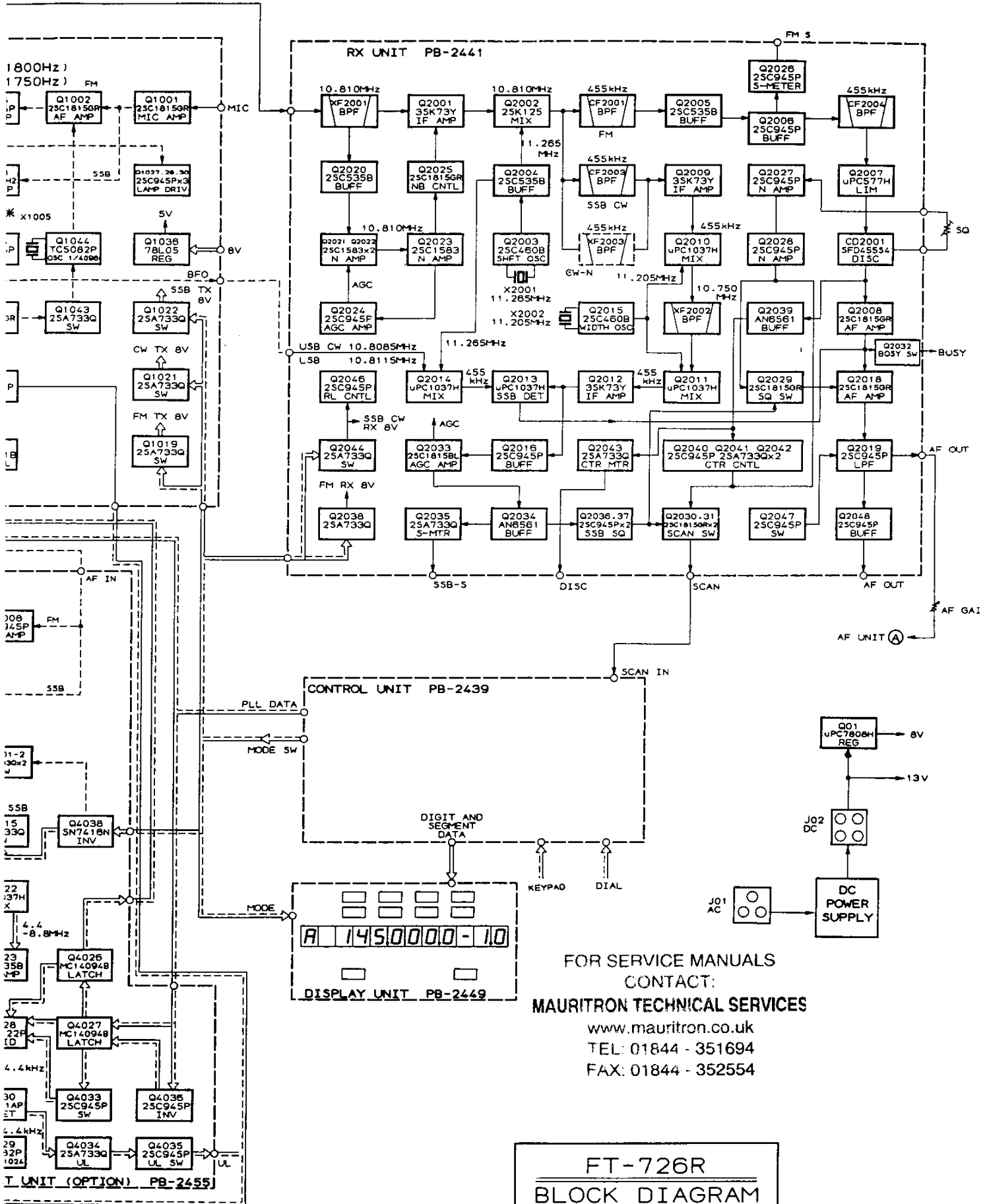

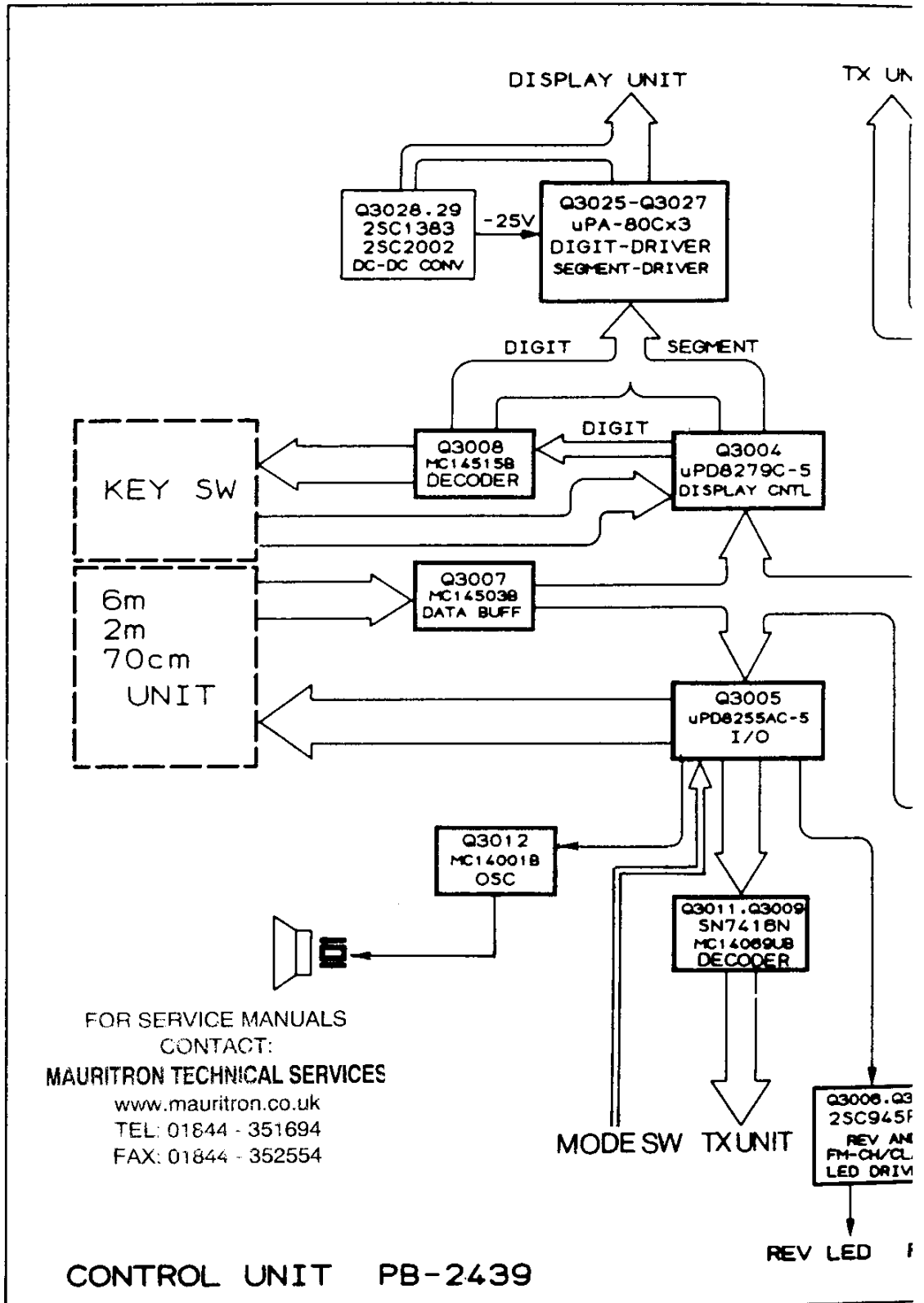

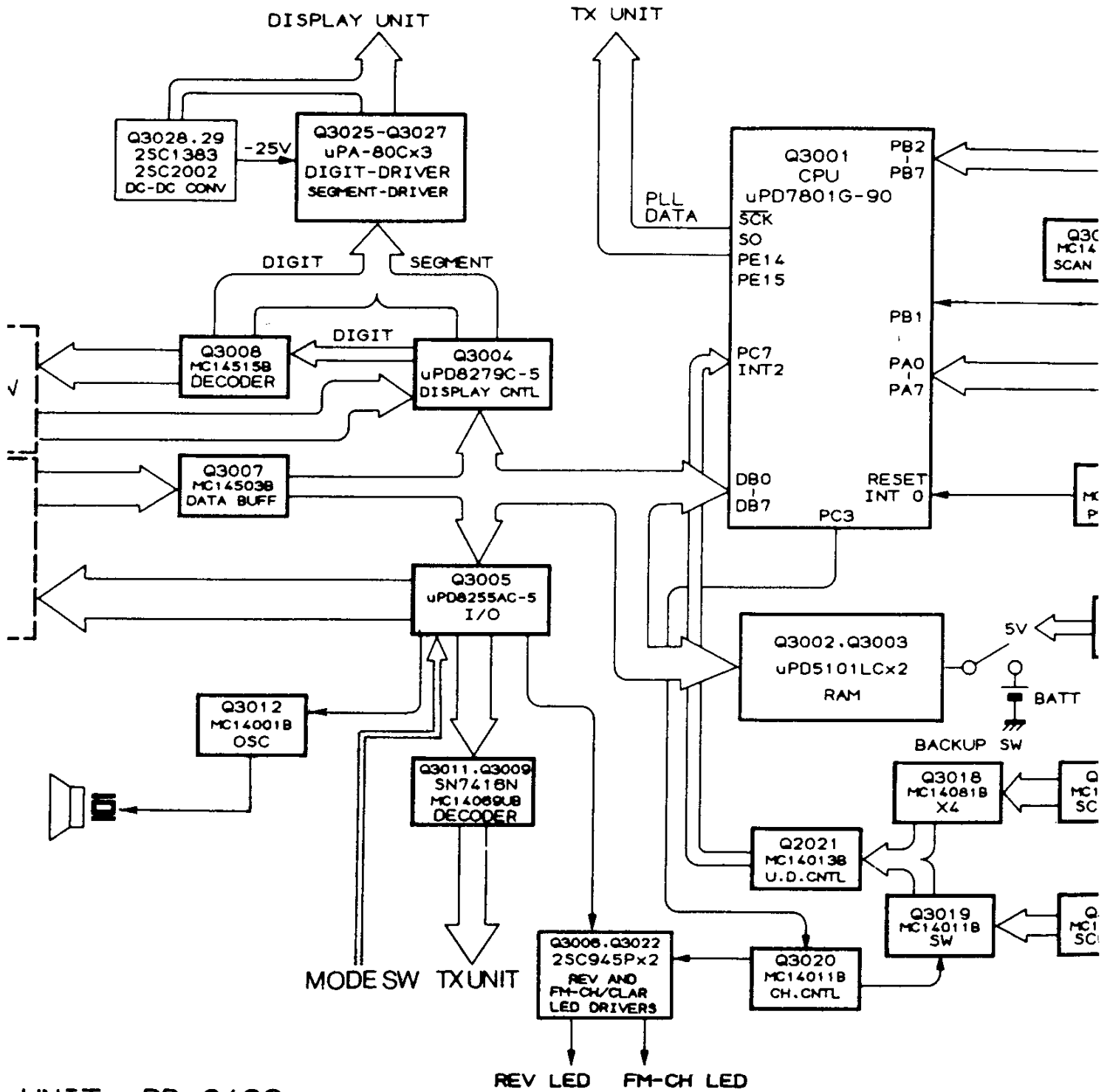

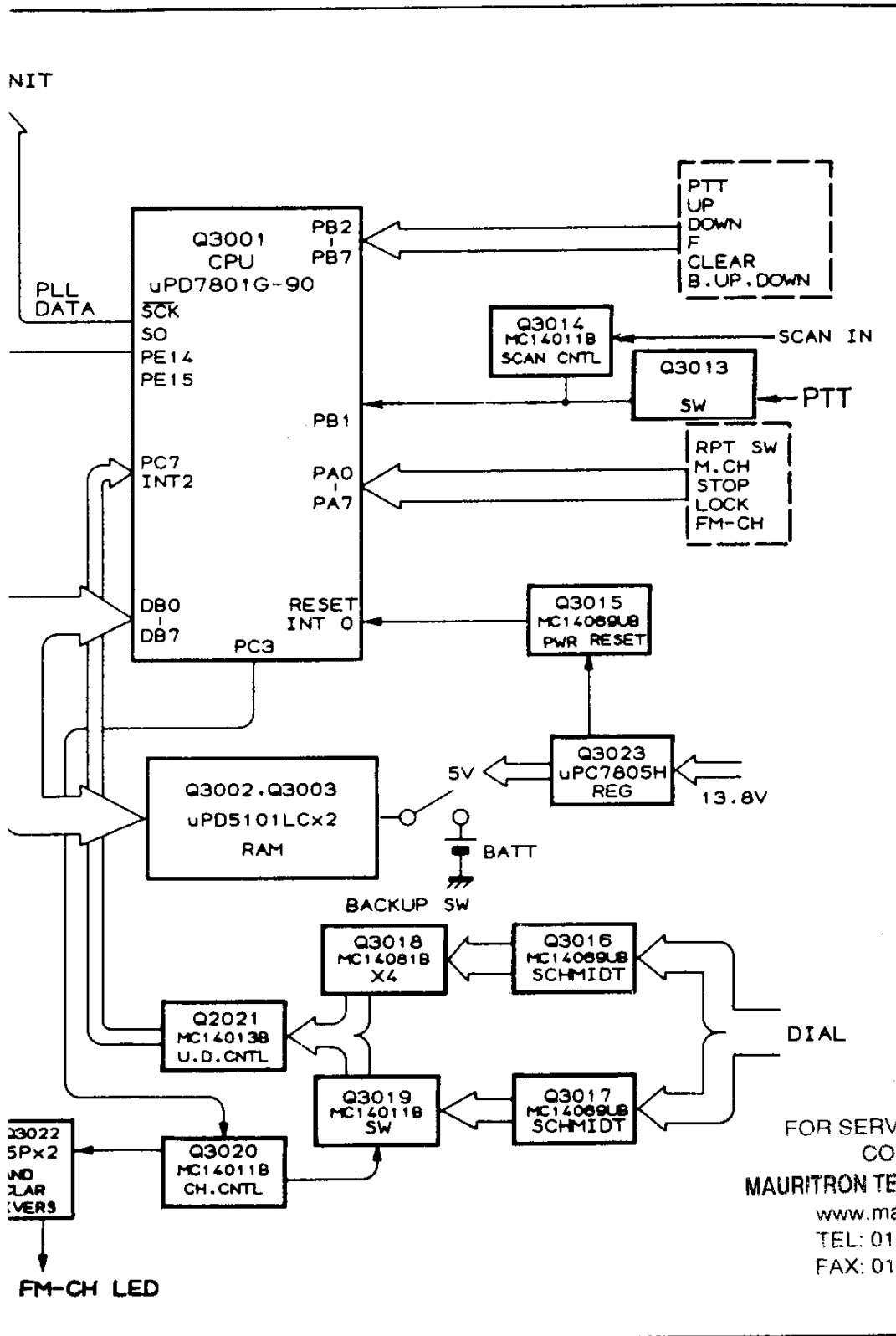

FOR SERVICE MANUALS
CONTACT:
MAURITRON TECHNICAL SERVICES
www.mauritron.co.uk
TEL: 01844 - 351694
FAX: 01844 - 352554

FT-726
CONTROL UNIT
BLOCK DIAGRAM

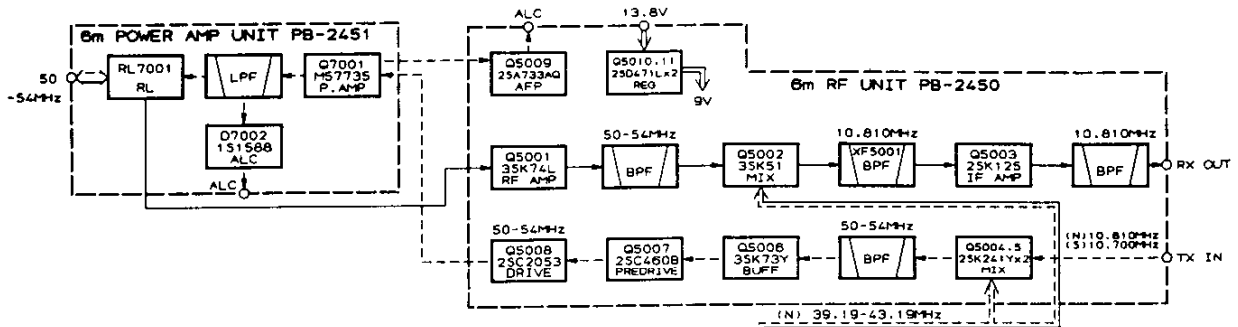

FT-726R
6m UNIT
BLOCK DIAGRAM

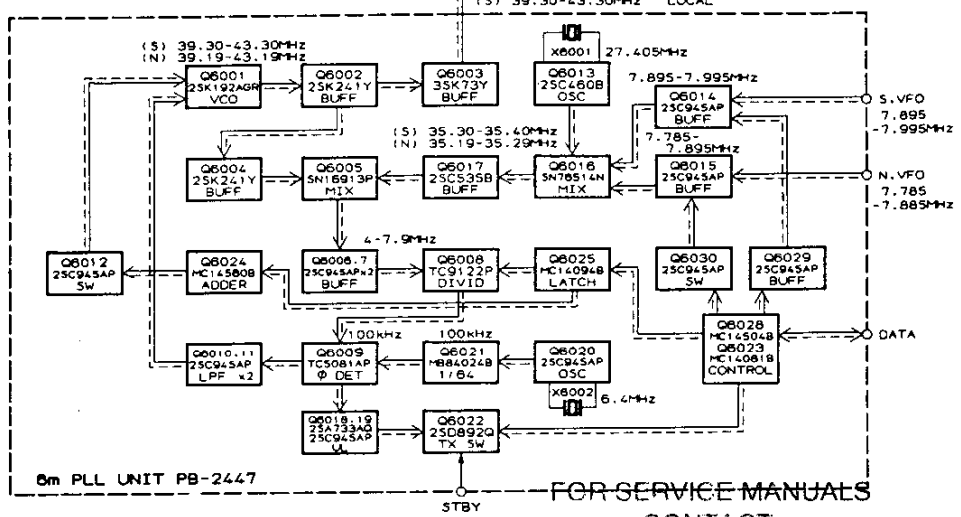

FOR SERVICE MANUALS
CONTACT:
MAURITRON TECHNICAL SERVICES
www.mauritron.co.uk
TEL: 01844 - 351694
FAX: 01844 - 352554

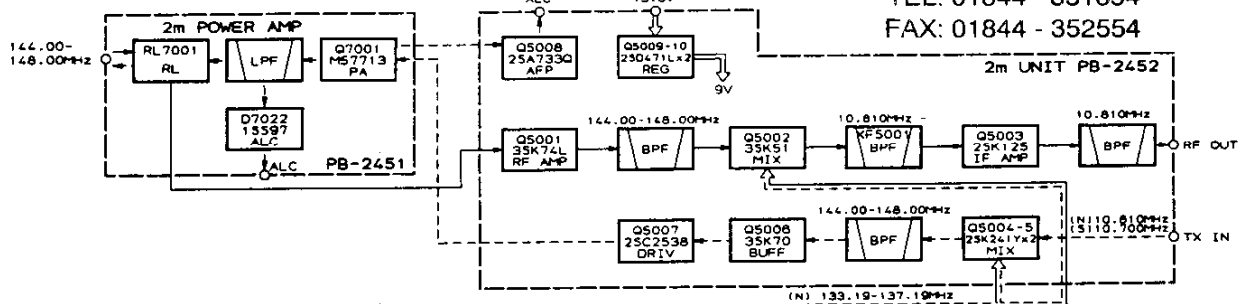

FT-726R
2m UNIT
BLOCK DIAGRAM

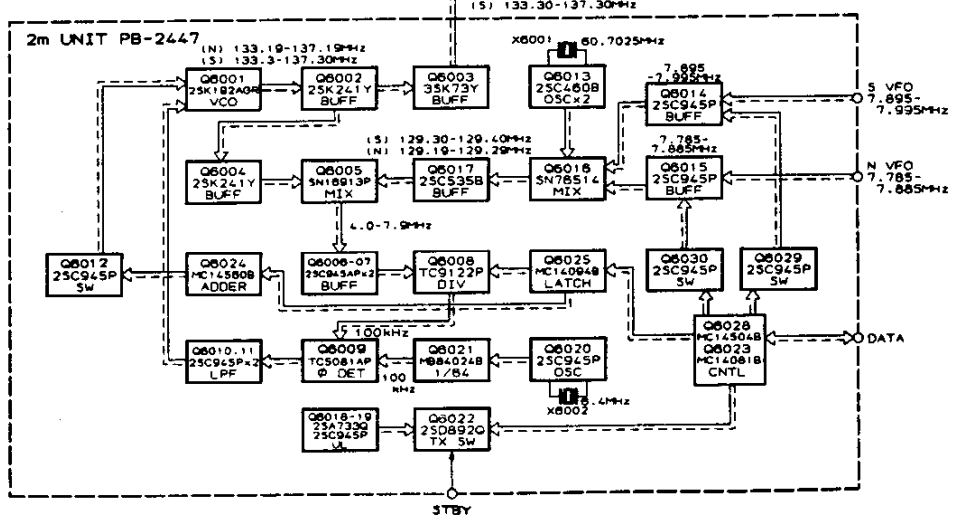

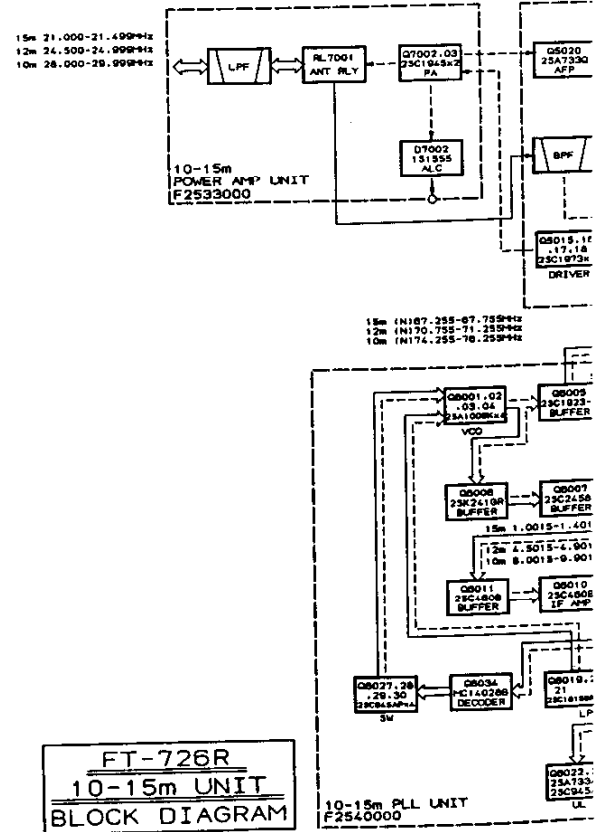
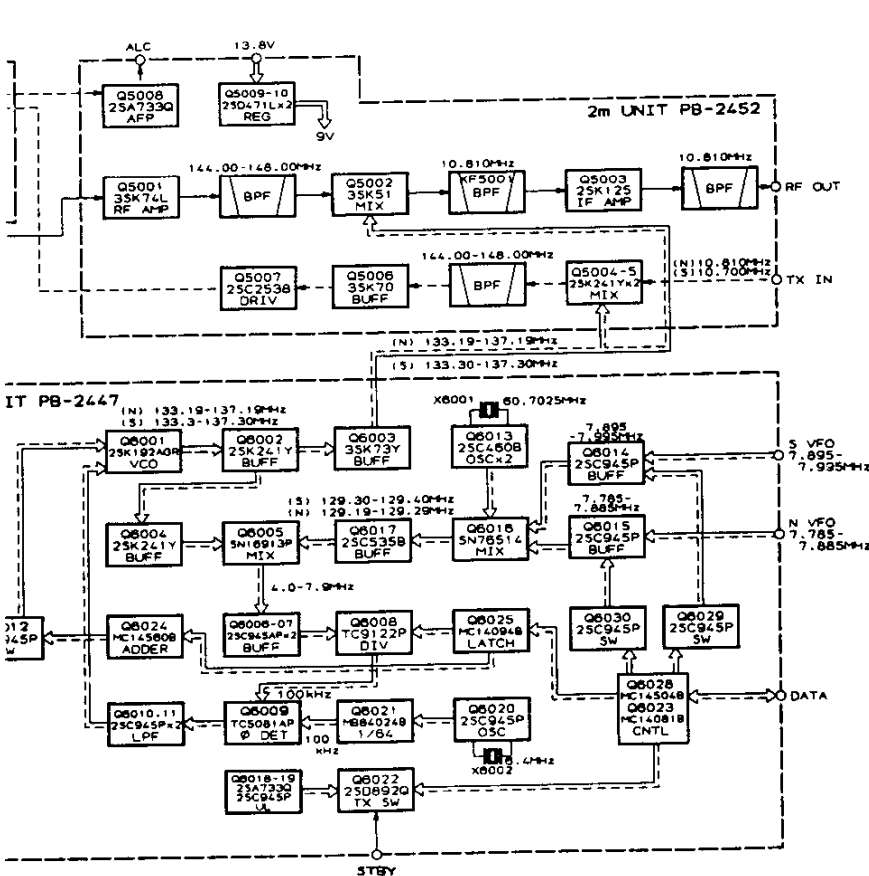
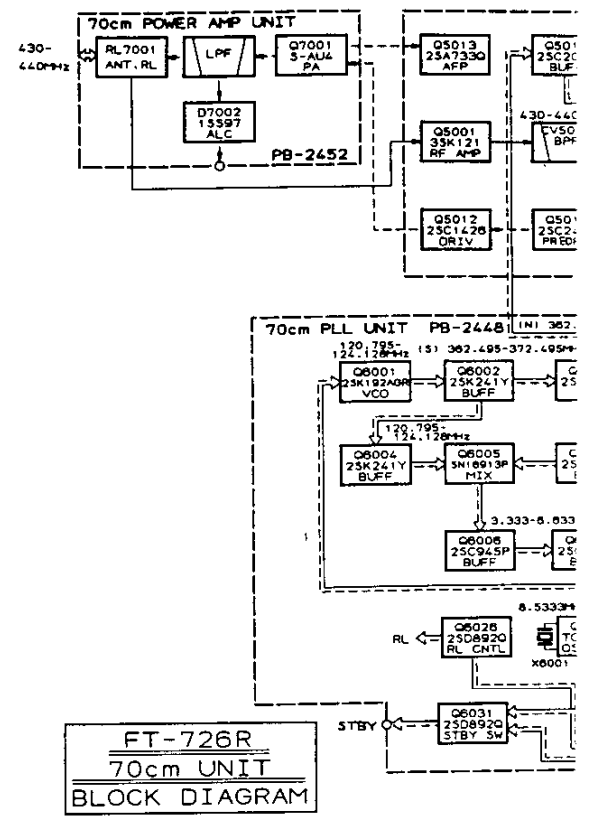
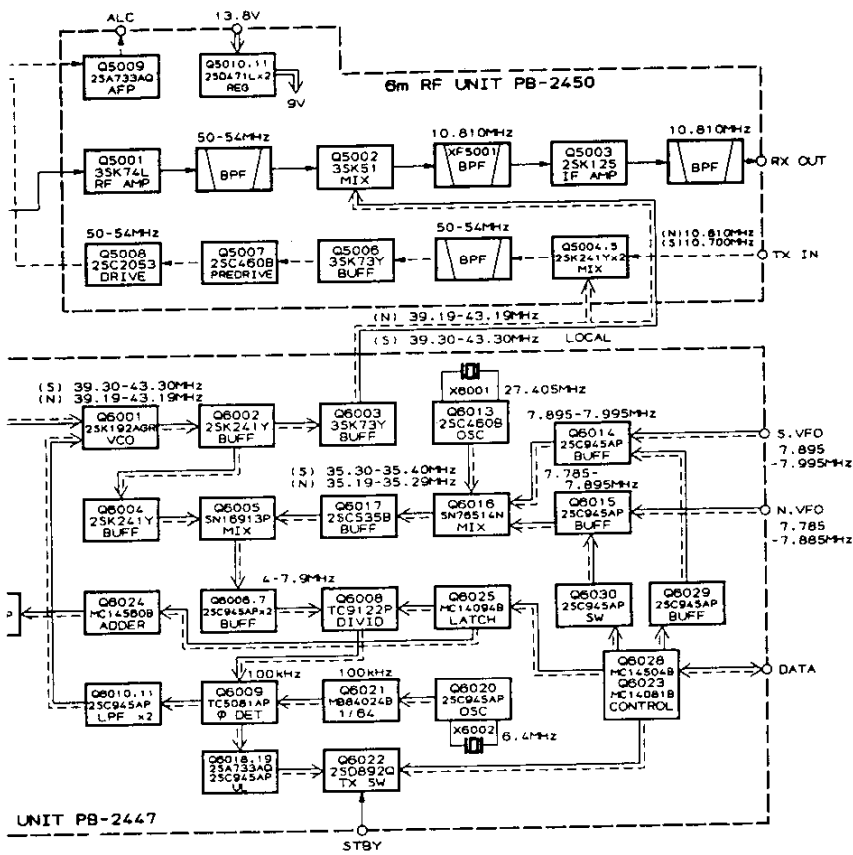

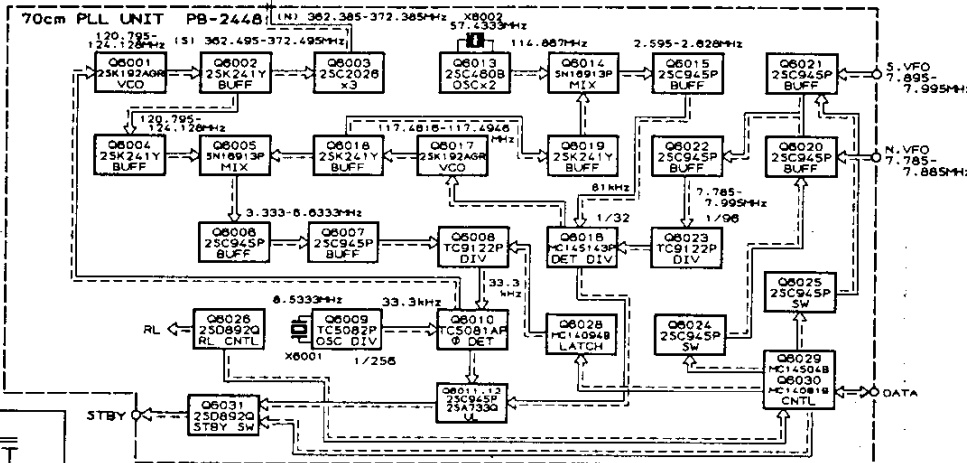
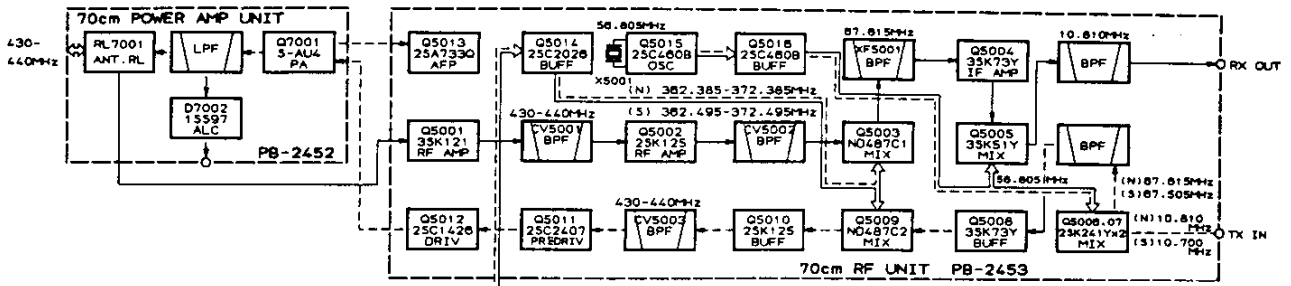

FT-726R
70cm UNIT
BLOCK DIAGRAM

FOR SERVICE MANUALS
CONTACT:
MAURITRON TECHNICAL SERVICES
www.mauritron.co.uk
TEL: 01844 - 351694
FAX: 01844 - 352554

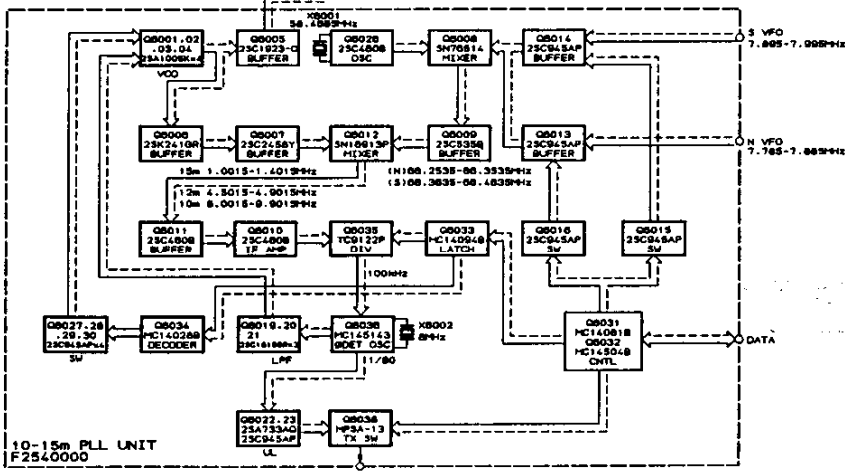
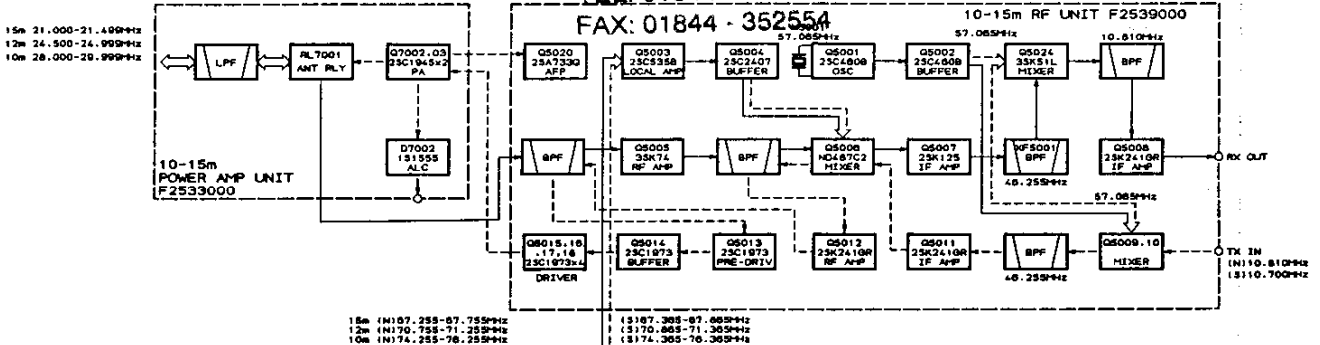

FT-726R
10-15m UNIT
BLOCK DIAGRAM

FRONT PANEL E)

FOR SERVICE MANUALS
CONTACT:
MAURITRON TECHNICAL SERVICES

www.mauritron.co.uk
TEL: 01844 - 351694
FAX: 01844 - 352554

N4

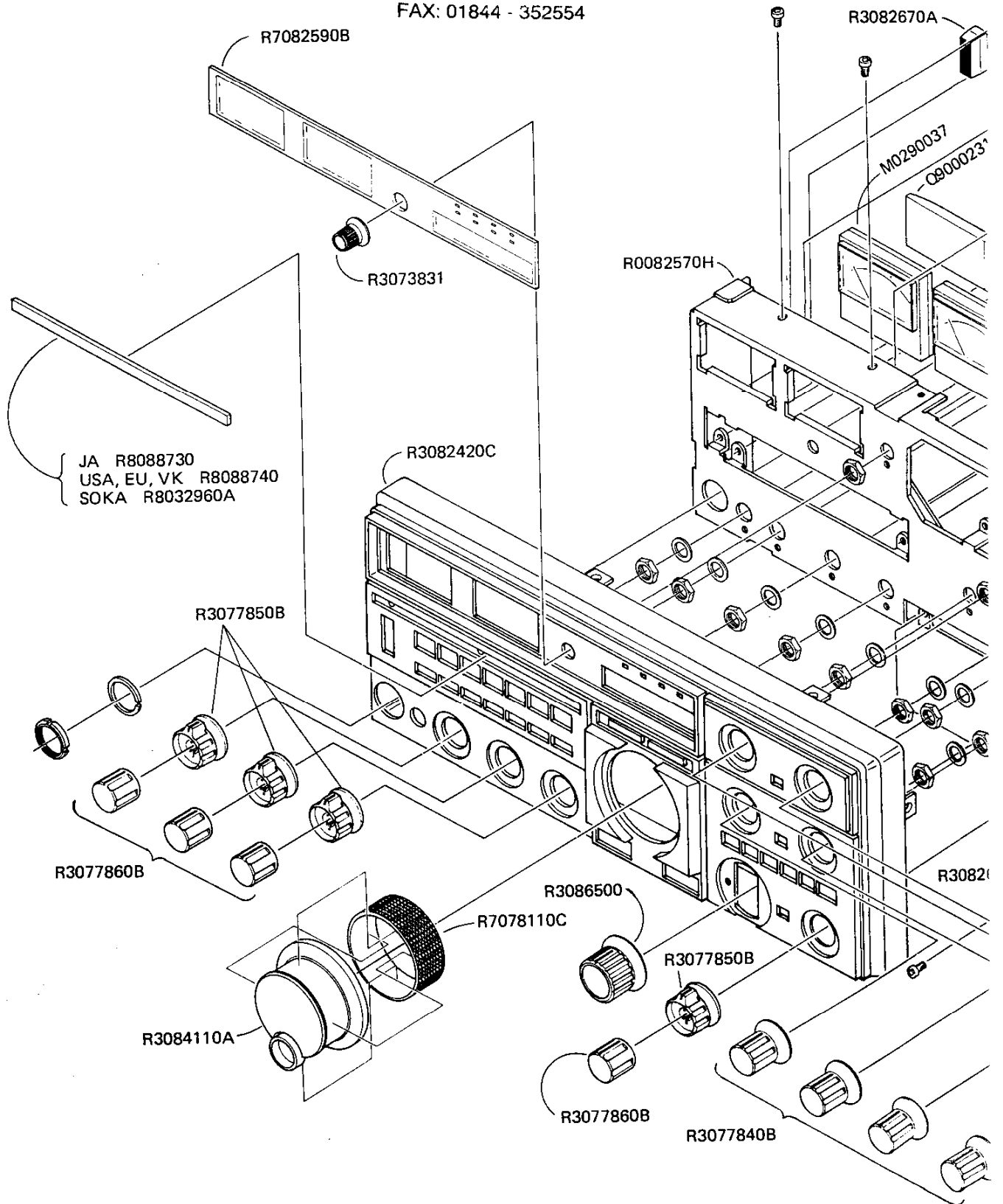

FRONT PANEL EXPLODED VIEW

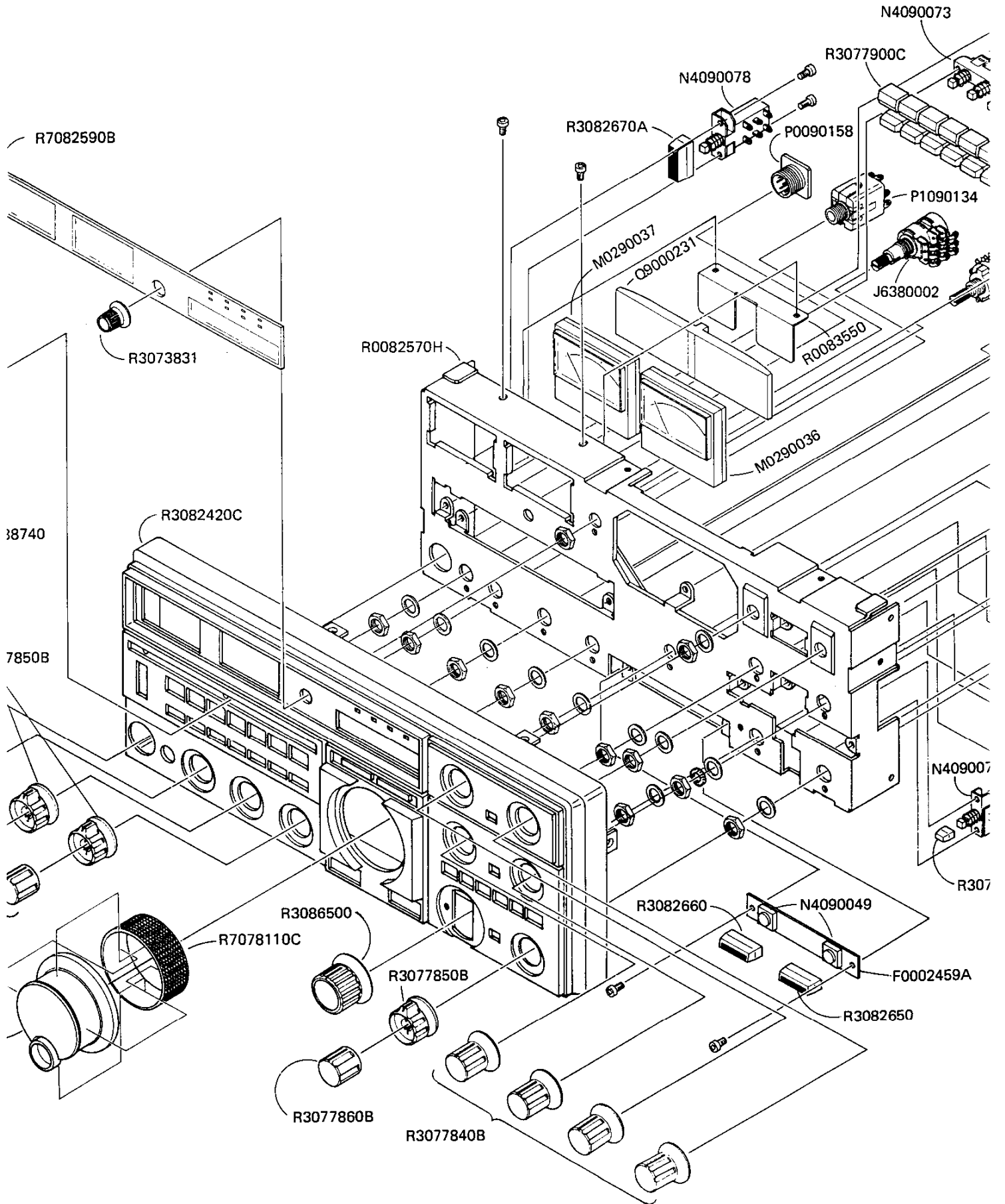

PANEL EXPLODED VIEW

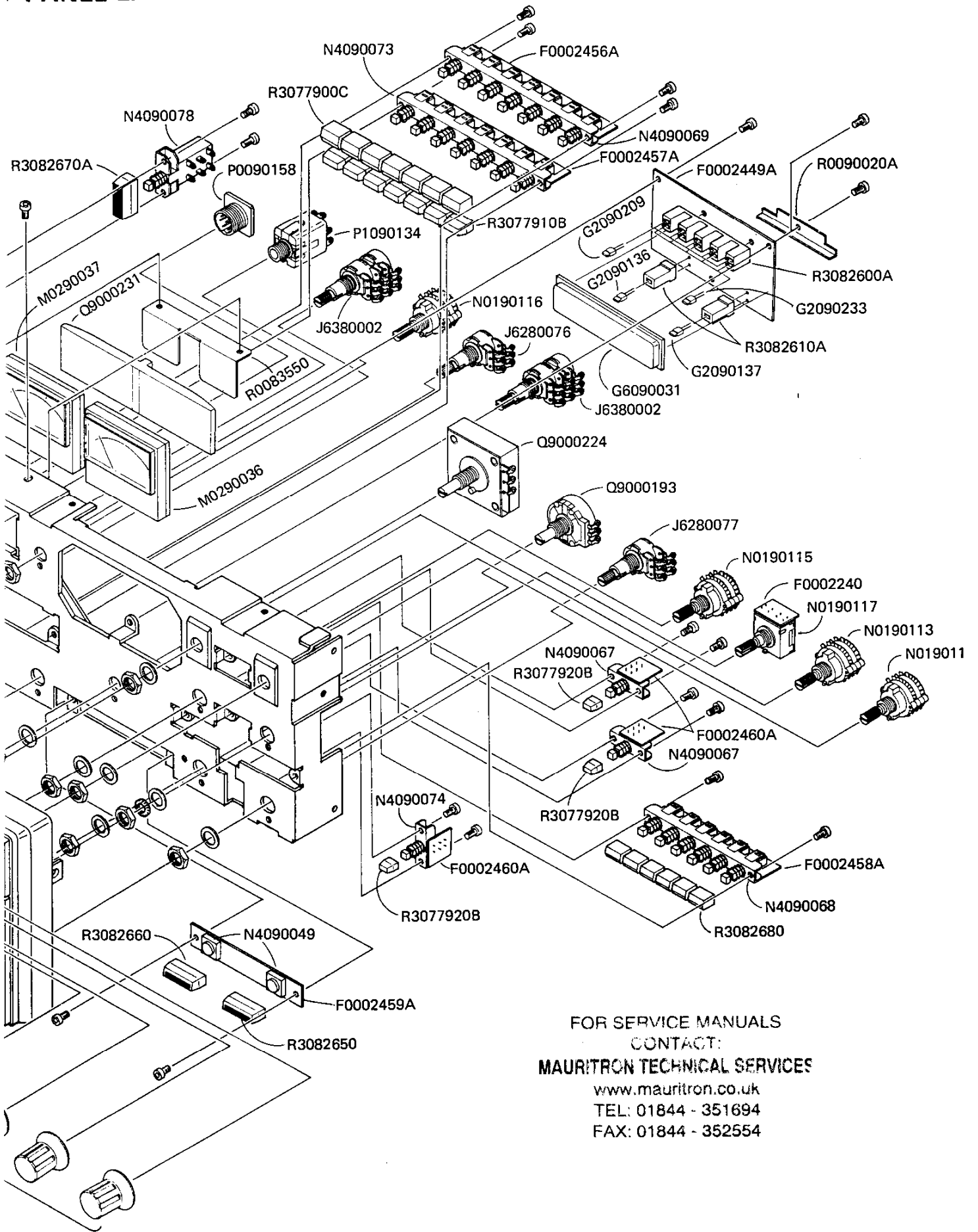

FOR SERVICE MANUALS
CONTACT:
MAURITRON TECHNICAL SERVICES
www.mauritron.co.uk
TEL: 01844 - 351694
FAX: 01844 - 352554

REAR PANEL EXP

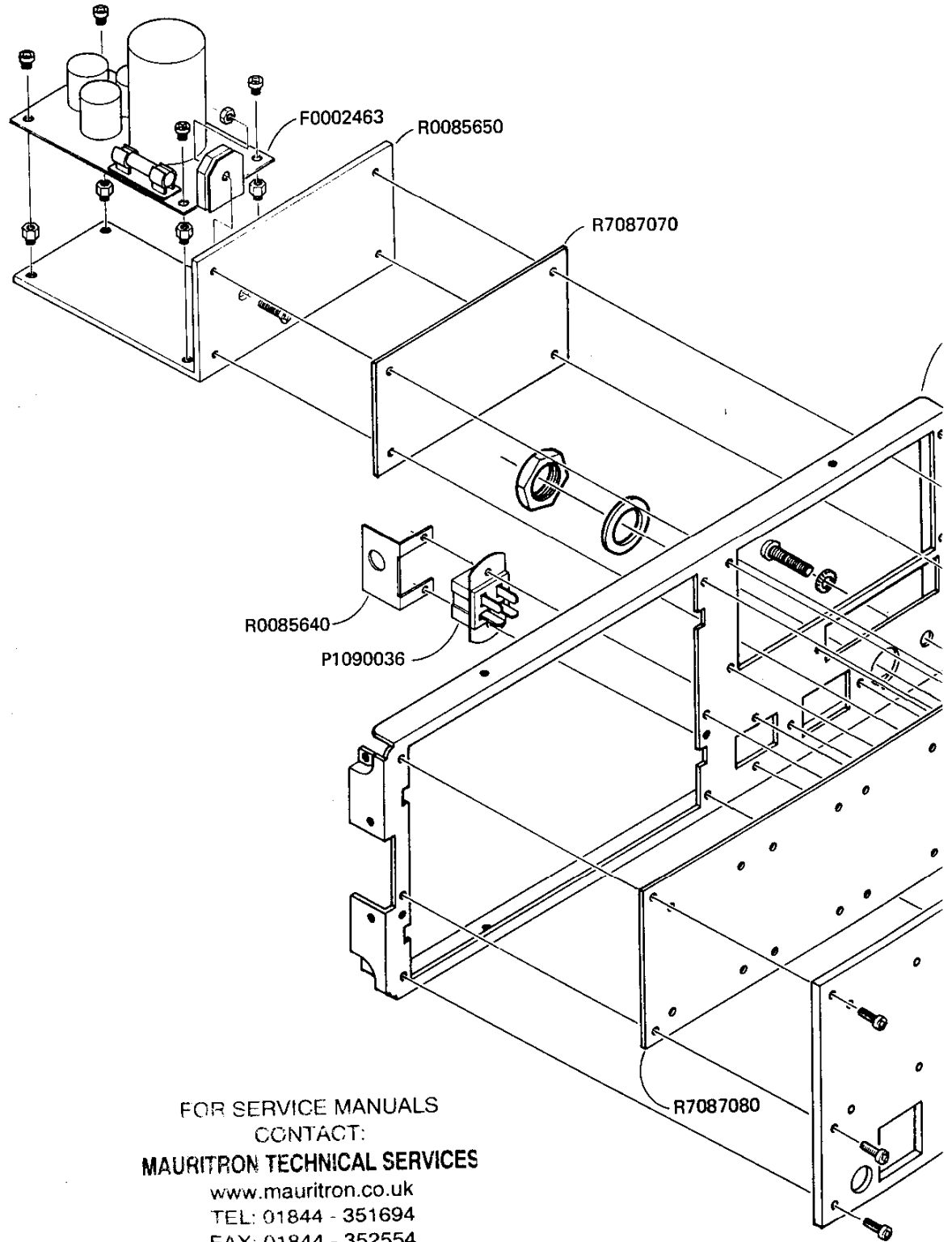

FOR SERVICE MANUALS
CONTACT:
MAURITRON TECHNICAL SERVICES
www.mauritron.co.uk
TEL: 01844 - 351694
FAX: 01844 - 352554

REAR PANEL EXPLODED VIEW

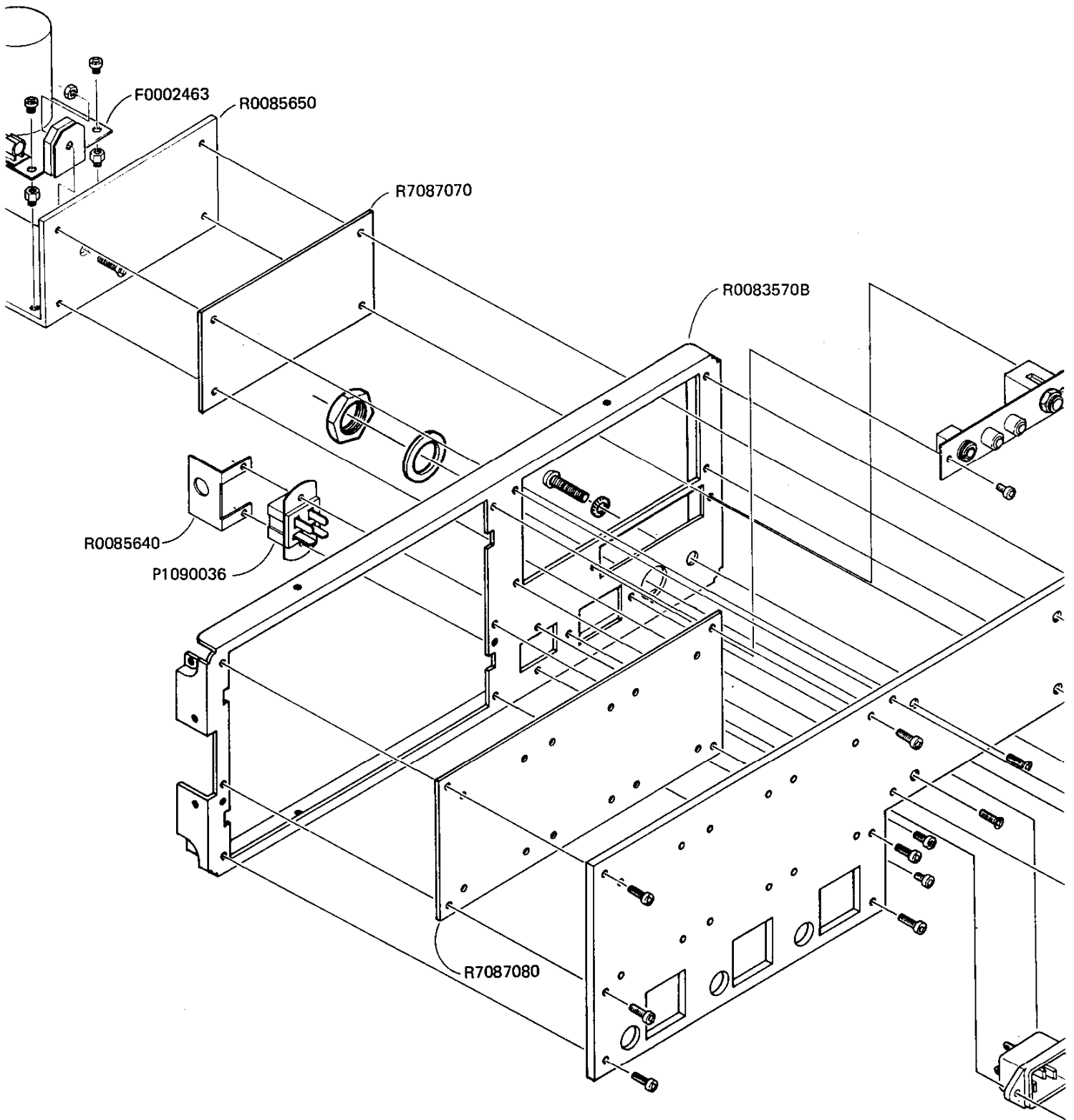

IEL EXPLODED VIEW

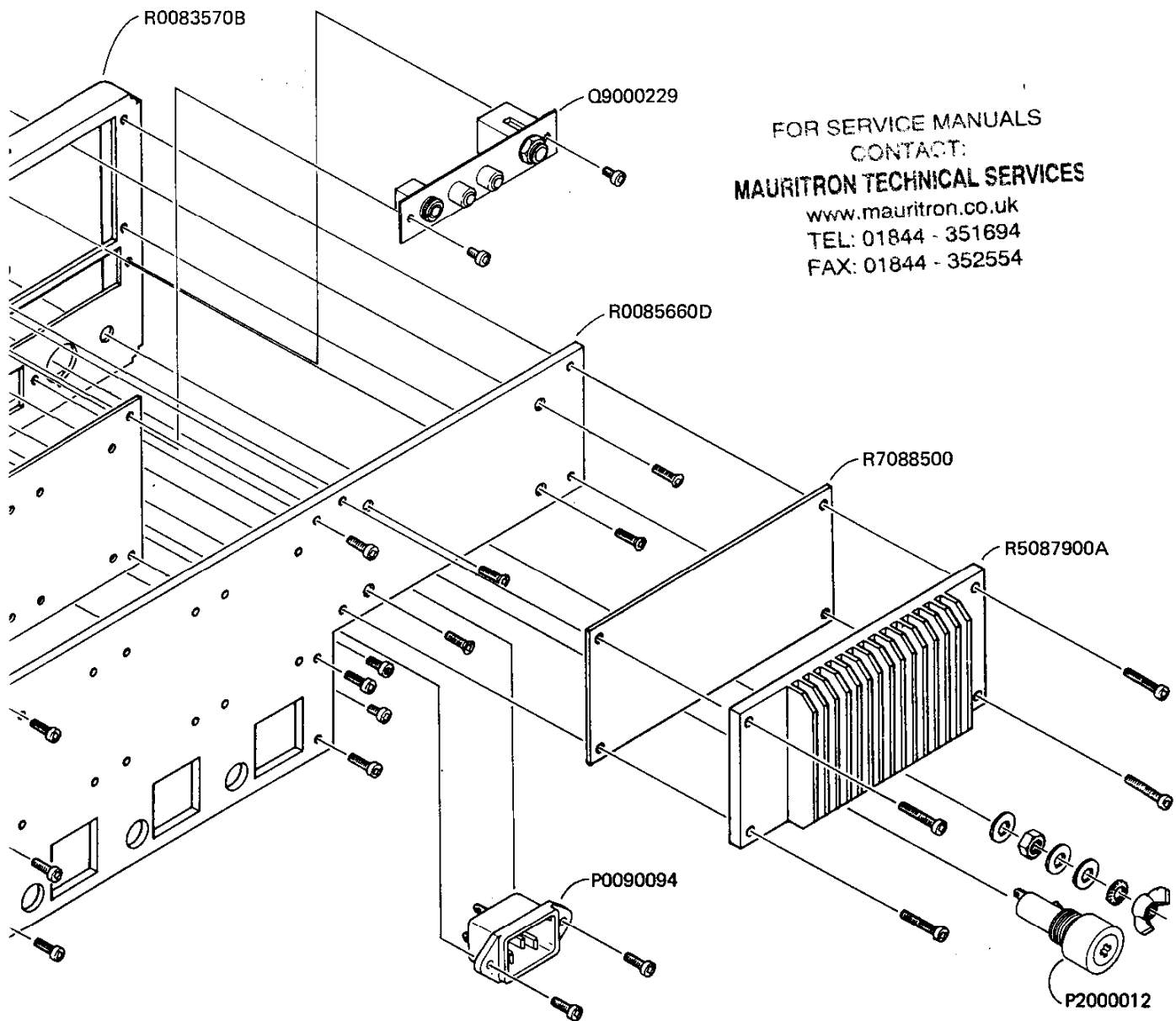

FOR SERVICE MANUALS
CONTACT:
MAURITRON TECHNICAL SERVICES
www.mauritron.co.uk
TEL: 01844 - 351694
FAX: 01844 - 352554

PARTS LIST

MAIN CHASSIS			VR3	J62800076	K16BA0A07-10KBx2 10KΩB-10KΩB
Symbol No.	Part No.	Description			
		SWITCH UNIT A			
PB-2456A	F0002456A C024560A	Printed Circuit Board PCB with S2			
			C1,2	K13179008	CAPACITOR Ceramic 50WV F 0.01μF (DD106F103Z50V)
			C3,4	K12329001	" 1.2KVAC 0.01μF (ECKDAL103PE)
PB-2457A	F0002457A C024570A	Printed Circuit Board PCB with S3			
			C5	K19149017	Semiconductor Ceramic 25WV 0.022μF (UAT06X223K-L45AE)
			C6-10	K12171102	Ceramic 50WV E 0.001μF (DD104E102P50V)
		SWITCH UNIT C			
PB-2458A	F0002458A C024580A	Printed Circuit Board PCB with S10, D1			
					METER
			M1	M0290036	S/ALC
			M2	M0290037	PO/DISC
		SWITCH UNIT D			
PB-2459A	F0002459A C024590A	Printed Circuit Board PCB with S5, S6			
					SPEAKER
			SP1	M4090047 T9100301	SS-77KYH 8Ω 2W Speaker Lead
		SWITCH UNIT E			
PB-2460A	F0002460A C024600A	Printed Circuit Board PCB with S8, D2			
					SWITCH
			S1	N4090078	NE15J 1P-0022AC2020
			S2	N4090069	SUJ-72A/E3891805M
			S3	N4090073	SUJ-72A/E6057717M
PB-2460A	F0002460A C024601A	Printed Circuit Board PCB with S11			
			S4	Q9000224	LA24034
			S5,6	N4090049	KHC10901
			S7	N0190113	SRN-2046/E3891856M
			S8,11	N4090067	SUJ-12A/E42129790
			S9	N0190114	SRN-2083N/E3891848M
PB-2460A	F0002460A C024602A	Printed Circuit Board PCB with S14			
			S10	N4090068	SUJ-61A/E3891813M
			S12	N0190115	SRN-1034N/E6058322M
			S13	N0190117	SRS-101C
			S14	N4090074	SUJ-12A/E6058306M
			S15	Q9000193	EWT-XDDS2050B
PB-2240	F0002240 C022400	Printed Circuit Board PCB with S13			
			S16	N0190116	SRN-1043N/204657690
					CONNECTOR
		IC	J1	P0090094	PA-125
Q1	G1090294	μPC7808H	J2	P1090036	QS-AB4M
			J7	P0090158	FM214-8SS
			J8	P1090134	SG7627
			J3,4,5,6	Q9000229	PIN JACK BOARD (KEY, EXT SPKR, ALC, PTT)
D3	G2090232	Si S11B			
D1,2	G2090208	LED PR4632K			
					POWER TRANSFORMER
		RESISTOR	PT1	L3030104A	
R3	J20306100	Metallic film 1W 10Ω			
R1,2	J10276101	Carbon Composition 1/2W GK 100Ω			TERMINAL
R4	J01245102	" film 1/4W TJ 1kΩ		Q6000003	1L2P (1-0-1)
R5	J01245152	" " " " 1.5kΩ		Q6000077	ML-3161C-8P
		POTENTIOMETER			FUSE HOLDER
VR1,4	J63800002	K16C5000C-10KB-50KB-10KA 10KΩB/50KΩB, 10KΩA	FH1	P2000012	SN2059
VR2	J62800077	K16B1000L-10KBx2 10KΩB-10kΩB			
				Q9000231	LIGHT PLATE (with lamp)

		PLUG		TRANSISTOR	
P1 (with wire)	T9204636A			Q120	G3107331Q 2SA733AQ
P2 (")	T9204634F			Q109	G3304600B 2SC460B
P3 (")	T9204635			Q103,108,110	G3305350B 2SC535B
P12 (")	T9204501A			Q117-119,121	G3309451P 2SC945AP
P13 (")	T9204502A				
P14 (")	T9204503A				
P19 (")	T9204637				
P20 (")	T9204508B			D102-104	G2090027 Si 1SS53
P26 (")	T9204513A			D101	G2090107 Varactor 1T25
		FUSE			CRYSTAL
	Q0000003	2A	100V-117VAC	X101	H0102504 HC-18/U 6.38MHz
	Q0000002	1A	200V-234VAC	X102	H0102503 HC-18/U 4.505MHz

		KNOB		TH101	G9090016 33D28
	R3084110A	FT-50T	TUNING		
	R7078110B	Rubber Ring			
	R3086500	FT-29T	FM-CH/CLAR	R115,123,126	J02245560 Carbon film 1/4W SJ 56Ω
	R3077840B	FT-22WK	RPT SELECT, SATELLITE, VFO, MEMORY	R104,107,117,121,138,142	J02245101 " " " " 100Ω
	R3077850B	FT-22WDNS	DRIVE, WIDTH, SQL, TONE	R151	J01245101 " " " TJ 100Ω
	R3077860B	FT-15WK	MIC GAIN, AF GAIN, RF GAIN, SHIFT	R106,109	J02245221 " " " SJ 220Ω
				R103	J02245331 " " " " 330Ω
				R111,113,129,137,141	J02245471 " " " " 470Ω
				R147	J02245561 " " " " 560Ω
	R3073831	FT-13UTK	SAT METER	R136,146,150	J02245102 " " " " 1kΩ
	R3077900B	PUSH KNOB A	PROC...D.LOCK	R116	J01215152 " " 1/8W TJ 1.5kΩ
				R145	J02245152 " " 1/4W SJ 1.5kΩ
	R3077910	" "	G LSB...UP	R128	J02245182 " " " " 1.8kΩ
	R3077920	" "	H REVERSE, VFO A=B,STEP	R144,148	J02245272 " " " " 2.7kΩ
				R110,114,130	J02245332 " " " " 3.3kΩ
	R3082670	" "	I POWER	R131-133,149	J02245392 " " " " 3.9kΩ
	R3082680	" "	J VFO...MW	R152,155	J02245472 " " " " 4.7kΩ
	R3082650	KEY TOP A	BAND UP	R112	J02245682 " " " " 6.8kΩ
	R3082660	" "	B BAND DOWN	R143,158	J02245103 " " " " 10kΩ
				R154	J02245153 " " " " 15kΩ
				R134,140,157	J02245223 " " " " 22kΩ
					J02245333 " " " " 33kΩ
				R102,105,108,135,139	J02245473 " " " " 47kΩ
VFO UNIT				R153	J02245563 " " " " 56kΩ
Symbol No.	Part No.	Description		R101,156	J02245104 " " " " 100kΩ
PB-2445A	C024450A	Printed Circuit Board		R127	J02245154 " " " " 150kΩ
	C024450A	PCB with Components		R109	J02245334 " " " " 330kΩ
		IC			CAPACITOR
Q104	G1090296	HD10551P		C114,133,169	K00172010 Ceramic 50WV SL 1pF (DD104SL010C50V)
Q111,112	G1090343	MC14094B			
Q115	G1090473	TC5081AP		C111	K02179003 " " CK 2pF (DD104CK020C50V)
Q114	G1090239	TC5082P			
Q113	G1090247	TC9122P		C131	K00172030 " " SL 3pF (DD104SL030C50V)
Q105,107	G1090101	μPC1037H			
				C102,103	K05173060 " " RH 6pF (DD104RH060D50V)
		FET		C107	K06173060 " " UJ 6pF (DD104UJ060D50V)
Q116	G3800301Y	2SK30AY			
Q101	G3801921G	2SK192AGR			
Q102,106	G3802410Y	2SK241Y			
					K02173060 " " CH 6pF (DD104CH060D50V)

C159	K00172050	Ceramic 50WV SL 5pF (DD104SL050C50V)	C108,118,147,178, 180,183,188,191	K40129012	Electrolytic 16WV 10μF (ECE-A1CK100)
C104,152	K02173090	" " CH 9pF (DD104CH090D50V)	C185	K40129013	" " 22μF (ECE-A1CK220)
C105	K02173100	" " " 10pF (DD104CH100D50V)			
C155	K02175120	" " " 12pF (DD104CH120J50V)			TRIMMER CAPACITOR
C165,168,170	K05175120	" " RH 12pF (DD104RH120J50V)	TC101,102	K91000055	ECV1ZW 06x53N 6pF
C136,173	K00175150	" " SL 15pF (DD104SL150J50V)	TC103	K91000028	ECV1ZW 10x53 10pF
C151	K06175150	" " UJ 15pF (DD104UJ150J50V)			INDUCTOR
C154	K02175180	" " CH 18pF (DD104CH180J50V)	L102	L1190004	FL4H-R68M 0.68μH
C122	K00175180	" " SL 18pF (DD104SL180J50V)	L109,110	L1190070	FL4H-8R2M 8.2μH
C109	K06175220	" " UJ 22pF (DD104UJ220J50V)	L107	L1190029	FL5H-470K 47μH
C167	K00175220	" " SL 22pF (DD104SL220J50V)	L105	L1190030	FL5H-560K 56μH
C153,174,175	K02175330	" " CH 33pF (DD104CH330J50V)	L106	L1190031	FL5H-680K 68μH
C171	K00175330	" " SL 33pF (DD104SL330J50V)	L101,111,112	L1190016	FL5H-101K 100μH
C101	K06175470	" " UJ 47pF (DD104UJ470J50V)	L103,108	L1020680	
C141,143	K00175470	" " SL 47pF (DD104SL470J50V)			TRANSFORMER
C120	K00175560	" " " 56pF (DD104SL560J50V)	T101	L0020612	
C126	K00175680	" " " 68pF (DD104UJ470J50V)	T102,103	L0020782	
C124	K00175820	" " " 82pF (DD104SL820J50V)	T104-106	L0020825	
C125,142,163,189	K00175101	" " " 100pF (DD105SL101J50V)			CONNECTOR
C161	K06175101	" " UJ 100pF (DD106UJ101J50V)	J102	P0090041	5048-03A
C119	K00179015	" " SL 110pF (DD105SL111J50V)	J101	P0090037	5048-08A
C130,194	K00175151	" " " 150pF (DD106SL151J50V)			TP TERMINAL
C160	K06175151	" " UJ 150pF (DD107UJ151J50V)			Q5000036 TP-G
C121,123	K00179020	" " SL 240pF (DD107SL241J50V)			FERRITE BEADS
C196	K10176102	" " B 0.001μF (DD104B102K50V)	FB101	L9190001	Ri 3x3x1
C106,110,112,113, 115-117,128, 134,135,137,138, 140,144, 148-150, 156-158,162, 164,166,176,187, 190,193	K14180103	" " FZ 0.01μF (RD871-1FZ-103Z63V)			DISPLAY UNIT
C127,129,132,139, 172,179,182,184, 186,192	K19149021	Semiconductor Ceramic 25WV 0.047μF (UAT08X473K-L45AE)	Symbol No.	Part No.	Description
C181	K54200001	Polycarbonate 100WV 1μF (B32561A1105J)	PB-2449A	F0002449A	Printed Circuit Board
	K40179005	Electrolytic 50WV 0.47μF (ECE-A1HKR47)		C024490A	PCB with Components
					FCD
			V201	G6090031	FIP12A5A
					DIODE
			D205-208	G2090209	LED BG4632K
			D201-204	G2090233	" PY4632K
			D210	G2090136	" TLG205
			D209	G2090137	" TLR205
					RESISTOR
			R202	J01245471	Carbon film 1/4W TJ 470Ω
			R203	J01245561	" " " " 560Ω
			R201	J01245152	" " " " 1.5kΩ

TX UNIT			CRYSTAL FILTER		
Symbol No.	Part No.	Description	XF1001	H1102074	XF-10.8LS 10.810MHz
PB-2440A	F0002440A	Printed Circuit Board			
	C024400A	PCB with Components Model F			RESISTOR
	C024400B	" Model A,X	R1021,1062,1072,1086,1122	J02245560	Carbon film 1/4W SJ 56Ω
	C024400C	" Model B,C,D,E			
		IC			
Q1031	G1090068	MC14011B	R1004,1032,1036,1045,1067,1094,1095,1120,1128,1166,1169,1170	J02245101	" " " TJ 56Ω
Q1032	G1090126	MC14069UB			" " " SJ 100Ω
Q1035	G1090053	MC14081B			
Q1044	G1090239	TC5082P			
Q1036	G1090084	μPC78L05	R1011,1044,1076	J02245221	" " " " 220Ω
Q1014	G1090101	μPC1037H	R1046,1176	J02245331	" " " " 330Ω
Q1003	G1090493	μPC1158H2	R1071	J02245471	" " " " 470Ω
			R1125	J02245681	" " " " 680Ω
			R1089	J02245821	" " " " 820Ω
		TRANSISTOR			
Q1040	G3104960Y	2SA496Y	R1001,1013,1043,1069,1084,1093	J02245102	" " " " 1kΩ
Q1015,1016,1021,1022,1025,1043	G3107331Q	2SA733AQ		J02245122	" " " " 1.2kΩ
			R1016,1022,1037,1061,1087,1106,1111,1121,1165	J02245222	" " " " 2.2kΩ
Q1008,1011,1017,	G3304600B	2SC460B			
Q1004-1007,1013,1027-1030,1033,1034,1037,1039	G3309451P	2SC945AP	R1063,1090	J02245332	" " " " 3.3kΩ
			R1031,1033,1132,1157,1162,1177	J02245472	" " " " 4.7kΩ
			R1178	J01245472	" " " TJ 4.7kΩ
Q1023	G3318150B	2SC1815BL	R1081-1083	J02245562	" " " 1/4W SJ 5.6kΩ
Q1001,1002,1041,1042	G3318150G	2SC1815GR	R1151	J01245682	" " " TJ 6.8kΩ
Q1038	G3090005	MPS-A13	R1005,1008,1009,1023,1025,1066,1096,1097,1102,1104,1105,1108,1126,1127,1129-1131,1148,1154,1156,1171,1172	J02245103	" " " SJ 10kΩ
		FET			
Q1012,1018	G4800730Y	3SK73Y			
			R1027	J02245123	" " " " 12kΩ
		DIODE			
D1001,1002	G2001880F	Ge 1S188FM	R1112	J02245153	" " " " 15kΩ
D1003,1004	G2015550	Si 1S1555	R1010,1012,1028,1041,1042,1054,1055,1060,1064,1091,1107,1136,1137,1173	J02245223	" " " " 22kΩ
D1018,1019	G2015880	" 1S1588			
D1007,1009,1016-1017,1020-1027,1029-1033,1036-1057,1059	G2090027	" 1SS53			
			R1114	J02245273	" " " " 27kΩ
			R1040	J02245333	" " " " 33kΩ
D1005	G2090180	Varactor FC53-M5	R1039,1074,1075,1077-1080,1098,1100,1101,1113,1152,1153,1155,1159,1160,1163,1164,1167	J02245473	" " " " 47kΩ
D1058	G9090007	Varistor MV12			
D1006	G9090005	" MV103			
D1008	G2090188	Zener HZ5C1			
		CRYSTAL			
X1001	H0102448	HC-18/T3P 10.810MHz	R1038,1059	J02245563	" " " " 56kΩ
X1002	H0102511	HC-18/U 10.8092MHz	R1014,1015,1024,1034,1065,1068,1070,1073,1092,1118,1142-1047,1149,1150,1168	J02245104	" " " " 100kΩ
X1003	H0100992	HC-18/U 10.8115MHz			
X1004	H0100991	HC-18/U 10.8085MHz			
X1005 (1750Hz Tone)	H0101982	HC-18/T 7.168MHz			
			R1140	J20249029	Metallic " " 130kΩ
X1005 (1800Hz Tone)	H0101983	HC-18/T 7.372MHz			
			R1003	J02245154	Carbon " " SJ 150kΩ
			R1026	J02245184	" " " " 180kΩ
			R1006,1019,1035,1119	J02245224	" " " " 220kΩ
		THERMISTOR			
TH1001	G9090001	SDT250	R1002,1007,1020,1030,1115	J02245334	" " " " 330kΩ
			R1029,1123	J02245474	" " " " 470kΩ
			R1109,1135,1139	J02245105	" " " " 1MΩ
			R1110,1138,1158	J02245155	" " " " 1.5MΩ

		POTENTIOMETER				
VR1006	J51745103	H0651A013-10KB	10k Ω	C1122	K70120006	" " 3.3 μ F (489D335X0016B1)
VR1002	J51745223	H0651A015-22KB	22k Ω	C1003,1005,1006, 1009,1013,1015, 1055,1119	K40179002	Electrolytic 50WV 0.1 μ F (ECE-A1HK0R1)
VR1001,1008	J51745473	H0651A017-47KB	47k Ω			
VR1005,1009	J51745104	H0651A019-100KB	100k Ω	C1011, 1016-1018, 1026,1027, 1087,1089,1091, 1096,1097,1117	K40179001	Electrolytic 50WV 1 μ F (ECE-A1HK010)
VR1007	J51745474	H0651A023-470KB	470k Ω			
		CAPACITOR				
C1029	K06172040	Ceramic 50WV UJ 4pF (DD104UJ040J50V)		C1014,1056	K40149011	" 25WV 4.7 μ F (ECE-A1EK4R7)
C1048,1060	K00173100	" " SL 10pF (DD104SL100D50V)		C1022	K40129015	" 16WV 4.7 μ F (ECE-A1CK4R7)
C1110	K00175150	" " " 15pF (DD104SL150J50V)		C1012,1023,1024, 1032,1033,1054, 1085,1090,1102, 1103,1108,1114	K40129012	" " 10 μ F (ECE-A1CK100)
C1043,1062,1063	K06175270	" " UJ 27pF (DD104UJ270J50V)		C1052	K40129013	" " 22 μ F (ECE-A1CK220)
C1111	K00175330	" " SL 33pF (DD104SL330J50V)		C1053	K40109010	" 10WV 47 μ F (ECE-A1AK470)
C1004,1061	K00175470	" " " 47pF (DD104SL470J50V)		C1007	K40109001	" " 100 μ F (10RE100)
	K00175820	" " " 82pF (DD104SL820J50V)				TRIMMER CAPACITOR
C1064	K06175151	" " UJ 150pF (DD107UJ151J50V)		TC1002-1004	K91000029	ECV-1ZW 20x53 20pF
C1030,1031	K06175181	" " " 180pF (DD104UJ181J50V)				INDUCTOR
C1044,1045	K06175221	" " " 220pF (DD109UJ221J50V)		L1002	L1190014	FL4H-100K
C1067	K00175221	" " SL 220pF (DD107SL221J50V)				TRANSFORMER
C1001,1002,1010, 1028,1057,1074, 1080-1082	K12171102	" " E 0.001 μ F (DD104E102P50V)		T1001	L0021354	
C1068	K10176152	" 50WV B 0.0015 μ F (DD104B152K50V)		T1002,1003	L0021163	
C1019,1070	K19149001	Semiconductor Ceramic 25WV 0.001 μ F (UAT04X102K-L05AE)				RELAY
C1020	K19149011	" " " 0.0068 μ F (UAT05X682K-L05AE)		RL1001,1002	M1190001	FBR211A009M
C1008,1021,1025, 1034,1042,1046, 1047,1084,1088, 1094, 1104-1107,1120	K13179008	Ceramic 50WV F 0.01 μ F (DD106F103Z50V)				CONNECTOR
C1100,1101,1115, 1116	K19149013	Semiconductor Ceramic 25WV 0.01 μ F (UAT05X103K-L05AE)		J1003	P0090050	5048-04A
C1099	K19149017	" " " 0.022 μ F (UAT06X223K-45AE)		J1005	P0090042	5048-05A
C1049,1051,1058, 1059,1066,1069, 1071,1072,1075, 1077,1078,1092, 1095,1113	K19149021	" " " 0.047 μ F (UAT08X473K-L45AE)		J1011	P0090051	5048-06A
C1098	K55209003	Polypropylene 0.0047 μ F (PRA4701F4700PF)		J1007,1010	P0090054	5048-07A
C1121	K70167154	Tantalum 35WV 0.15 μ F (CS15E1VR15M)		J1004,1009	P0090037	5048-08A
C1093	K70140005	" 25WV 0.47 μ F (489D474X0025A1)		J1008	P0090072	5048-09A
C1083	K70140007	" " 1 μ F (489D105X0025A1)		J1001	P0090052	5048-10A
C1109	K70127225	" 16WV 2.2 μ F (CS15E1C2R2M)		J1006	P0090038	5048-12A
				J1002	P0090039	5048-13A
						FERRITE BEADS
				FB1001-1003	L9190001	Ri 3x3x1
						RX UNIT
				Symbol No.	Part No.	Description
				PB-2441A	F0002441A	Printed Circuit Board
					C024410A	PCB with Components Model F
					C024410B	" Model A,B,C,D,E
						IC
				Q2034,2039	G1090500	AN6561
				Q2007	G1090072	μ PC577H
				Q2010,2011,2013, 2014	G1090101	μ PC1037H

		TRANSISTOR		R2145,2185	J02245101	Carbon film	1/4W SJ	100Ω
Q2035,2038, 2041-2044	G3107331P	2SA733AP		R2008,2067,2081	J02245151	" "	" "	150Ω
				R2024,2051,2109	J02245221	" "	" "	220Ω
Q2003,2015	G3304600B	2SC460B		R2032,2049	J02245471	" "	" "	470Ω
Q2004,2005,2020	G3305350B	2SC535B		R2202	J01245471	" "	1/8W TJ	470Ω
Q2006,2016,2019, 2024, 2026-2028, 2032,2036,2037, 2040,2046-2048	G3309451P	2SC945AP		R2151,2186	J02245681	" "	1/4W SJ	680Ω
				R2011,2018,2037, 2075,2179,2138, 2095	J02245102	" "	" "	1kΩ
Q2021-2023	G3315830B	2SC1583B		R2123,2127	J00215152	" "	1/8W VJ	1.5kΩ
Q2033	G3318150B	2SC1815BL		R2007,2036,2066, 2080,2119	J02245152	" "	1/8W SJ	1.5kΩ
Q2008,2018,2025, 2029-2031	G3318150G	2SC1815GR		R2001,2014,2026, 2039,2040,2052, 2056,2057,2059, 2060,2062,2085, 2092,2099,2117, 2146,2150	J02245222	" "	" "	2.2kΩ
		FET						
Q2002	G3801680D	2SK168D						
Q2001,2009,2019	G4800730Y	3SK73Y		R2028,2142, 2143	J02245332	" "	" "	3.3kΩ
				R2003	J02245392	" "	" "	3.9kΩ
		DIODE						
D2004,2005,2023, 2024,2026,2027, 2029-2032	G2001880F	Ge	1S188FM	R2041,2050,2115, 2165,2192,2199	J02245472	" "	" "	4.7kΩ
				R2002,2023,2029, 2042,2043,2130, 2144,2153,2181	J02245562	" "	" "	5.6kΩ
D2025	G2090118	Schottky Barrier	1SS97					
D2028	G2015550	Si	1S1555	R2128	J00215682	" "	1/8W VJ	6.8kΩ
D2002,2003, 2009-2013, 2033-2035, 2038-2040, 2043-2049	G2090027	"	1SS53	R2136	J02245822	" "	1/4W SJ	8.2kΩ
				R2031,2110,2135, 2147,2162,2173, 2193	J02245103	" "	" "	10kΩ
D2001	G2090180	Varactor	FC53M-5	R2111,2158,2161, 2177	J02245153	" "	" "	15kΩ
				R2126	J00215153	" "	1/8W VJ	15kΩ
		CRYSTAL						
X2002	H0102514	HC-18/U3P	11.205MHz	R2004,2017,2022, 2030,2045,2058, 2061,2090,2091, 2112,2118,2120, 2149,2164,2166, 2167-2169, 2171,2172,2174, 2178,2184	J02245223	" "	1/4W SJ	22kΩ
X2001	H0102513	HC-18/U3P	11.265MHz					
		THERMISTOR						
TH2001	G9090001	SDT250		R2009,2016,2122, 2124	J00215223	" "	1/8W VJ	22kΩ
				R2064,2078	J02245273	" "	1/4W SJ	27kΩ
				R2027,2096,2105, 2107,2132,2148, 2182,2194	J02245473	" "	" "	47kΩ
		CRYSTAL FILTER						
XF2001	H1101980	108M15A		R2201	J01215823	" "	1/8W TJ	82kΩ
XF2002	H1102075	XF-10.7LW		R2191	J00215104	" "	1/8W VJ	100kΩ
				R2005,2015,2033, 2063,2077,2089, 2106,2133,2140, 2141,2195, 2198	J02245104	" "	1/4W SJ	100kΩ
		CERAMIC FILTER						
CF2004	H3900071	LF-B20		R2035,2044,2065, 2097,2108,2116, 2139	J02245224	" "	" "	220kΩ
CF2003	H3900040	LF-C2A						
CF2001	H3900204	LF-H15S		R2048,2170	J02245274	" "	" "	270kΩ
				R2113,2131,2175, 2176	J02245334	" "	" "	330kΩ
		CERAMIC DISCRIMINATOR						
CD2001	H7900040/60	SFD455S4/455DW-8		R2114,2163	J02245474	" "	" "	470kΩ
				R2157	J02245105	" "	" "	1MΩ
		RESISTOR						
R2010,2012,2013, 2020,2025,2068, 2070,2076,2082, 2083,2087,2088, 2093,2094	J02245560	Carbon film	1/4W SJ 56Ω					
						POTENTIOMETER		
					J51745472	H0651A011-4.7KB		4.7kΩB
R2038,2046,2098, 2121,2129,2134, 2137	J02245101	" "	" " 100Ω	VR2001,2002, 2004,2005,2007, 2008	J51745103	H0651A013-10KB		10kΩB
				VR2006	J51745223	H0651A015-22KB		22kΩB
R2034,2125	J00215101	" "	1/8W VJ 100Ω	VR2003	J51745473	H0651A017-47KB		47kΩB

CAPACITOR					
C2016	K00172020	Ceramic 50WV SL 2pF (DD104SL020C50V)	C2099,2141	K70167104	Tantalum 35WV 0.1μF (CS15E1V0R1M)
C2081	K02179003	" " CH 2pF (DD104CK020C50V)	C2144	K70120002	" 16WV 10μF (489D106X0016C1)
C2017	K00172050	" " SL 5pF (DD104SL050C50V)	C2145,2154	K40179002	Electrolytic 50WV 0.1μF (ECE-A1HK0R1)
C2002,2049,2112, 2126	K00173100	" " " 10pF (DD104SL100D50V)	C2035,2036,2076, 2093,2098,2102, 2116,2122,2128, 2133,2155	K40179001	" " 1μF (ECE-A1HK010)
C2063	K00175150	" " " 15pF (DD104SL150J50V)	C2132,2144	K40129015	" 16WV 4.7μF (ECE-A1CK4R7)
C2010	K06175180	" " UJ 18pF (DD104UJ180J50V)	C2033,2040,2072, 2103,2119,2127, 2130,2143,2150, 2151,2157	K40129012	" " 10μF (ECE-A1CK100)
C2059,2086	K00175270	" " SL 27pF (DD104SL270J50V)	C2158	K40109002	" 10WV 47μF (10RE47)
C2003	K00175470	" " " 47pF (DD104SL470J50V)			INDUCTOR
C2068	K00175101	" " " 100pF (DD105SL101J50V)	L2001	L1190029	FL5H-470K 47μH
C2012,2013	K06175221	" " UJ 220pF (DD109UJ221J50V)	L2010	L1190016	FL5H-101K 100μH
C2026	K00175221	" " SL 220pF (DD107SL221J50V)	L2007	L1190038	FL5H-271K 270μH
C2069,2079, 2139	K00175331	" " " 330pF (DD107SL331J50V)	L2002,2003	L1190040	S4-1MH 1mH
C2082,2083	K06179018	" " UJ 330pF (DD110UJ331J50V)	L2005,2006,2011	L1190090	LAL04NA102K 1mH
C2115	K10176471	" " " 470pF (DD104B471K50V)			TRANSFORMER
C2008,2039,2053, 2062,2078,2097, 2104,2124,2149	K12171102	" " E 0.001μF (DD104E102P50V)	T2001-2003	L0021161	
C2014,2058,2070, 2084,2113,2121, 2134	K13179008	" " F 0.01μF (DD106F103Z50V)	T2004,2009-2011	L0190094	
C2021,2024,2034, 2064,2101,2140	K19149001	Semiconductor Ceramic 25WV 0.001μF (UAT04X102K-L05AE)	T2005	L0021258	
C2004,2114	K19149005	" " 0.0022μF (UAT04X222K-L05AE)	T2006,2014-2016	L0021162	
C2140	K19149009	" " 0.0047μF (UAT05X472K-L05AE)	T2007,2008	L0020188	
C2100	K19149011	" " 0.0068μF (UAT05X682K-L05AE)	T2012	L0021257	
C2022,2025,2046, 2047,2074,2129, 2136-2138, 2153,2156	K19149013	" 25WV 0.01μF (UAT05X103K-L05AE)			RELAY
C2146,2147	K19149017	" " 0.022μF (UAT06X223K-L45AE)	RL2001	M1190002	FBR211AD012M
C2038	K19149019	" " 0.033μF (UAT06X333K-L45AE)			CONNECTOR
C2001, 2005-2007, 2009, 2018-2020, 2023, 2027-2032, 2037, 2043-2045, 2048, 2050-2052, 2054,2060,2061, 2065-2067, 2071,2073,2075, 2077,2080,2085, 2087,2089,2092, 2105-2111, 2117,2118,2120, 2123,2131,2135, 2142,2148,2152, 2159	K19149021	" " 0.047μF (UAT08X473K-L45AE)	J2001-2003, 2007,2008,2013	P0090041	5048-03A
			J2004	P0090050	5048-04A
			J2005,2009	P0090042	5048-05A
			J2010	P0090051	5048-06A
			J2006	P0090054	5048-07A
			J2012	P0090352	3022-03A
					PLUG
			P2001 (with wire)	T9204522	
					TP TERMINAL
				Q5000036	TP-G
					FERRITE BEADS
			FB2001	L9190001	Ri 3x3x1

FOR SERVICE MANUALS
CONTACT:
MAURITRON TECHNICAL SERVICES
www.mauritron.co.uk
TEL: 01844 - 351694
FAX: 01844 - 352554

CONTROL UNIT			R3045,3056, 3065-3068,3074	J02245103	Carbon film 1/4W SJ 10kΩ
Symbol No.	Part No.	Description			
PB-2439B	F0002439B	Printed Circuit Board	R3070	J02245153	" " " " 15kΩ
	C024390A	PCB with Components	R3001,3004,3006, 3011,3024	J02245223	" " " " 22kΩ
			R3073	J01215223	" " 1/8W TJ 22kΩ
		IC	R3015-3017, 3046,3050, 3052-3055,3057 3063	J02245473	" " 1/4W SJ 47kΩ
Q3012	G1090027	MC14001B		J02245563	" " " " 56kΩ
Q3014,3020	G1090068	MC14011B		J02245823	" " " " 82kΩ
Q3021	G1090067	MC14013B	R3031-3034	J02245104	" " " " 100kΩ
Q3009,3015-3017	G1090126	MC14069UB	R3014,3018,3021, 3042,3059		" " " " 100kΩ
Q3019	G1090492	MC14072B	R3072	J01215104	" " 1/8W TJ 100kΩ
Q3018	G1090053	MC14081B	R3019,3020, 3025-3028,3058	J02245334	" " 1/4W SJ 330kΩ
Q3007	G1090490	MC14503B	R3060	J02245474	" " " " 470kΩ
Q3008	G1090491	MC14515B	R3008,3010,3041	J02245105	" " " " 1MΩ
Q3011	G1090501	SN7416N	R3029,3035,3038, 3039	J02245155	" " " " 1.5MΩ
Q3025-3027	G1090488	μPA80C	R3007,3009,3030, 3036,3037,3040	J02245335	" " " " 3.3MΩ
Q3023	G1090299	μPC7805H			
Q3002,3003	G1090227	μPD5101LC			
Q3001	G1090489	μPD7801G-090			
Q3005	G1090406	μPD8255AC-5			
Q3004	G1090405	μPD8279C-5			
		TRANSISTOR			BLOCK RESISTOR
Q3010,3013,3022, 3024	G3309451P	2SC945AP	RB3003	J40900021	RA 3.3kΩ-8A 3.3Kx8
			RB3001	J40900050	EXB-P86-473K 47Kx6
Q3028	G3313830R	2SC1383R	RB3002	J40900032	EXB-P88-104K 100Kx8
Q3029	G3320020L	2SC2002L			
Q3006	G3408920Q	2SD892Q			
					POTENTIOMETER
			VR3001	J50714103	V8K-1-1B 10kΩ
		DIODE			
D3001-3010, 3014-3017, 3019-3029, 3031,3033,3034	G2090027	Si 1SS53			CAPACITOR
			C3006,3007	K00179007	Ceramic 50WV SL 30pF (DD104SL300J50V)
D3012,3013	G2090118	Schottky Barrier 1SS97	C3019,3020-3022	K00175101	" " " " 100pF (DD105SL101J50V)
D3032	G2090177	Zener HZ3B2			
D3011	G2090218	" HZ9C1	C3004,3005,3009, 3029	K12171102	" " " " E 0.001μF (DD104E102P50V)
D3030	G2090143	" HZ11B1			
			C3001-3003, 3010,3012,3013, 3024,3025,3027, 3033,3035,3039, 3041	K14180103	" " " " 63WV FZ 0.01μF (RD871-1FZ-103Z63V)
		CERAMIC RESONATOR			
X3001	H7900110	CSA 4.00MT			
			C3045	K13179008	" " " " 50WV F 0.01μF (DD106F103Z50V)
		BUZZER			
BZ3001	M4290003	PZS-22A	C3023,3026, 3030-3032,3043	K14170473	" " " " FZ 0.047μF (DD111FZ473Z50V)
			C3008	K19149025	Semiconductor Ceramic 25WV 0.1μF (UAT13X104K-L46AE)
		LITHIUM BATTERY			
BAT3001	Q9000106	CR2025	C3037	K50177102	Mylar 50WV 0.001μF (50F2U102M)
			C3044	K70167104	Tantalum 35WV 0.1μF (CS15E1V0R1M)
		RESISTOR			
R3062	J10276829	Carbon Composition 1/2W GK 8.2Ω	C3028	K40179010	Electrolytic 50WV 0.47μF (50RER47)
R3071	J20336560	Metallic film 2W 56Ω	C3040	K40149008	" " " " 25WV 10μF (25RE10)
R3044,3049,3061	J02245271	Carbon " 1/4W SJ 270Ω			
R3064	J02245122	" " " " 1.2kΩ	C3011,3034,3042	K40129004	" " " " 16WV 10μF (16RE10)
R3012,3013,3023	J02245222	" " " " 2.2kΩ			
R3002,3003,3047, 3048,3069	J02245472	" " " " 4.7kΩ	C3038	K40179014	" " " " 50WV 10μF (50RE10)
R3005,3022,3043	J02245103	" " " " 10kΩ			

C3014	K40089003	Electrolytic 6.3WV 47 μ F (ECE-A0JK470)	D4032-4034	G2090027	Si	1SS53
			D4031	G2090107	Varactor	1T25
			D4006	G2090180	"	FC53M-5
			D4007	G2090041	Varistor	MV103
		TRANSFORMER	D4008	G2090188	Zener	HZ5C1
T3001	L3030101					
						CRYSTAL
		CONNECTOR	X4001	H0100511	HC-18/U	10.7015MHz
J3013	P0090351	3094-02A	X4002	H0100512	HC-18/U	10.6985MHz
J3008	P0090050	5048-04A	X4003	H0102510	HC-18/U	10.700MHz
J3009	P0090042	5048-05A	X4004	H0102512	HC-18/U	10.6992MHz
J3007	P0090051	5048-06A	X4005	H0102515	HC-18/U	6.4713MHz
J3003,3011	P0090054	5048-07A	X4006	H0102503	HC-18/U	4.5056MHz
J3006,3012	P0090037	5048-08A				
J3002,3005	P0090072	5048-09A				
J3004,3010	P0090038	5048-12A				THERMISTOR
J3001	P0090036	5048-14A	TH4001	G9090016	33D28	
		SWITCH				CRYSTAL FILTER
S3001	N6090037	SSS312	XF4001	H1102064	XF-10.7LS	
		TERMINAL BOARD				
	Q6000003	1L2PS (1-0-1)				RESISTOR
			R4066	J02245100	Carbon film	1/4W SJ 10 Ω
			R4009,4021,4081, 4089,4093	J02245560	" "	" " 56 Ω
SATELLITE UNIT (OPTION)						
Symbol No.	Part No.	Description				
PB-2455A	F0002455A	Printed Circuit Board	R4031,4033,4048, 4055,4070,4074, 4083,4087,4104, 4108,4117,4128	J02245101	" "	" " 100 Ω
	C024550A	PCB with Components				
			R4025,4041,4072, 4085	J02245221	" "	" " 220 Ω
		IC				
Q4019	G1090296	HD10551	R4037,4069	J02245331	" "	" " 330 Ω
Q4026,4027	G1090343	MC14094BCP	R4020,4077,4079, 4095,4103,4107	J02245471	" "	" " 470 Ω
Q4038	G1090501	SN7416N				
Q4030	G1090473	TC5081AP	R4115,4126	J02245561	" "	" " 560 Ω
Q4029	G1090239	TC5082P	R4008,4019,4026, 4040,4044,4102, 4114,4116	J02245102	" "	" " 1k Ω
Q4028	G1090247	TC9122P				
Q4037	G1090084	μ PC78L05				
Q4007,4020,4022	G1090101	μ PC1037H		J02245122	" "	" " 1.2k Ω
			R4080,4112,4120	J02245152	" "	" " 1.5k Ω
		TRANSISTOR				
Q4001,4002,4012, 4014,4015,4034	G3107331Q	2SA733AQ	R4094	J02245182	" "	" " 1.8k Ω
			R4032,4057	J02245222	" "	" " 2.2k Ω
			R4111,4113	J02245272	" "	" " 2.7k Ω
Q4003,4009,4010, 4024	G3304600B	2SC460B	R4049,4056,4076, 4082,4097-4099	J02245332	" "	" " 3.3k Ω
Q4018,4023,4025	G3305350B	2SC535B	R4067	J02245392	" "	" " 3.9k Ω
Q4006,4008,4032, 4033,4035,4036, 4039	G3309451P	2SC945AP	R4028,4119,4122	J02245472	" "	" " 4.7k Ω
			R4005-4007	J02245562	" "	" " 5.6k Ω
			R4078	J02245682	" "	" " 6.8k Ω
			R4054,4058,4062, 4064,4110,4118, 4124,4125	J02245103	" "	" " 10k Ω
		FET				
Q4031	G3800301Y	2SK30AY				
Q4016	G3801921G	2SK192AGR	R4038,4039,4042, 4043,4050,4052, 4053,4096,4100, 4106,4109	J02245223	" "	" " 22k Ω
Q4017,4021	G3802410Y	2SK241Y				
		DIODE				
D4018,4019	G201588	Si 1S1588	R4036	J02245333	" "	" " 33k Ω
D4001-4004, 4004-4017, 4020-4022, 4024-4027	G2090027	Si 1SS53	R4001-4004, 4023,4024,4035, 4059,4063,4065, 5071,4084,4101, 4105,4129	J02245473	" "	" " 47k Ω

R4034,4121	J02245563	Carbon film	1/4W SJ	56kΩ	C4083	K00175680	Ceramic	50WV SL	68pF
R4017,4018,4022, 4029,4051,4068, 4123,4127	J02245104	" "	" "	100kΩ	C4075	K00175820	" "	" "	82pF
R4092	J02245154	" "	" "	150kΩ	C4095	K06175101	" "	UJ	100pF
R4030	J02245224	" "	" "	220kΩ	C4076,4097,4116, 4135	K00175101	" "	SL	100pF
R4075	J02245334	" "	" "	330kΩ	C4070	K00179015	" "	" "	110pF
		POTENTIOMETER			C4003,4004,4094	K06175151	" "	UJ	150pF
VR4005	J51745223	H0651A015-22KB		22kΩB	C4079,4143	K00175151	" "	SL	150pF
VR4004	J51745104	H0651A019-100KB		100kΩB	C4028,4029,4033, 4034	K06175181	" "	UJ	180pF
		CAPACITOR			C4145	K00175221	" "	SL	220pF
C4065,4104,4107	K00172010	Ceramic	50WV SL	1pF	C4072,4074	K00179020	" "	" "	240pF
C4062	K02172020	" "	CH	2pF	C4026,4044	K12171102	" "	E	0.001μF
C4027	K06172040	" "	UJ	4pF	C4022,4031,4035, 4037,4038,4045, 4058,4061,4063, 4064, 4066-4068, 4081,4084, 4089-4091, 4096,4098,4100, 4101,4108, 4110-4112, 4114,4118,4120, 4121,4125,4133, 4136,4140	K14180103	" "	FZ	0.01μF
C4053,4054	K05173060	" "	RH	6pF	<p style="text-align: center;">FOR SERVICE MANUALS CONTACT: MAURITRON TECHNICAL SERVICES www.mauritron.co.uk TEL: 01844 - 351694 FAX: 01844 - 352554</p>				
C4057	K06173060	" "	UJ	6pF					
C4078	K00173060	" "	SL	6pF					
	K02173060	" "	CH	6pF					
C4093	K00173070	" "	SL	7pF					
C4055,4085	K02173090	" "	CH	9pF					
C4056	K02173100	" "	" "	10pF					
C4018	K00173100	" "	SL	10pF					
C4086	K02175120	" "	CH	12pF					
C4099,4103,4105	K05175120	" "	RH	12pF					
C4146	K00175120	" "	SL	12pF	C4129	K54200001	Polycarbonate	100WV	1μF
C4109,4122	K00175150	" "	" "	15pF	C4013	K40179002	Electrolytic	50WV	0.1μF
C4092	K06175150	" "	UJ	15pF		K40179005	" "	" "	0.47μF
C4073	K00175180	" "	" "	18pF	C4015,4023,4025, 4141,4142	K40179001	" "	" "	1μF
C4087	K02175180	" "	CH	18pF	C4014	K40129015	" "	16WV	4.7μF
C4001,4002,4032, 4059	K06175220	" "	" "	22pF	C4024,4030,4050, 4051,4060,4069, 4119,4126,4128, 4131,4134,4137	K40129012	" "	" "	10μF
C4102	K00175220	" "	SL	22pF	C4043,4139	K40129013	" "	" "	22μF
C4106	K00175330	" "	" "	33pF	C4148	K40109003	" "	10WV	330μF
C4088,4123,4124	K02179013	" "	CH	33pF	TRIMMER CAPACITOR				
C4016,4036,4115, 4117	K00175470	" "	SL	47pF	TC4005,4006	K91000055	ECV-1ZW	06x53N	6pF
C4052	K06175470	" "	UJ	47pF	TC4007	K91000028	ECV-1ZW	10x53	10pF
C4071	K00175560	" "	SL	56pF	TC4001-4003	K91000029	ECV-1ZW	20x53	20pF
		INDUCTOR			L4002	L0190017	ES21GN-110053		
					L4004,4009	L1020680			
					L4003	L1190010			

		TRANSISTOR			CAPACITOR	
Q5009	G3107331Q	2SA733AQ	C5051	K02182059	Ceramic	50WV CH 0.5pF (RD870-1NPO-0R5C63V)
Q5007	G3304600B	2SC460B	C5001,5013,5020,5051	K02179001	Ceramic	50WV CH 1pF (DD104CK010C50V)
Q5008	G3320530	2SC2053	C5011,5016,5018,5033	K02179003	"	" " " 2pF (DD104CK020C50V)
Q5010,5011	G3404710L	2SD471L	C5039,5040	K00173100	"	" " SL 10pF (DD104SL100D50V)
			DIODE			
D5007,5008,5014,5016,5018,5019,5023	G2090027	Si 1SS53	C5015,5048,5054,5071	K00175220	"	" " " 22pF (DD104SL220J50V)
D5017	G2090118	Schottky Barrier 1SS97	C5024	K00175330	"	" " " 33pF (DD104SL330J50V)
D5015	G2015540	Si 1S1554	C5076	K00175390	"	" " " 39pF (DD104SL390J50V)
D5006	G2090023	Varactor 1SV50	C5004,5060	K00175470	"	" " SL 47pF (DD104SL470J50V)
D5002-5005,5009-5003,5022	G2090107	" 1T25	C5003,5012,5017,5019	K06179009	"	" " UJ 56pF (DD104UJ560J50V)
D5001	G9090006	Varistor MV13	C5027	K06185820	"	" " UJ 82pF (RD871-1N750-820J63V)
D5021	G2090003	Si V06B	C5079	K00175820	"	" " SL 82pF (DD104SL820J50V)
D5020	G2090218	Zener HZ9C1	C5050,5052,5059,5063,5066	K00175101	"	" " SL 100pF (DD105SL101J50V)
			THERMISTOR			
TH5001	G9090008	31D26	C5044	K06175121	"	" " UJ 120pF (DD107UJ121J50V)
TH5002	G9090013	25D29	C5104	K10186221	"	" 63WV " 220pF (RD870-1B221K63V)
TH5003	G9090001	SDT250	C5045,5103	K10176102	"	" " B 0.001μF (DD104B102K50V)
			CRYSTAL FILTER			
XF5001	H1102021	108M30B	C5025,5034,5038,5078,5081,5086,5088,5099,5101,5105	K12171102	"	" 50WV E 0.001μF (DD104E102P50V)
			RESISTOR			
R5053,5054	J01245229	Carbon film 1/4W TJ 2.2Ω	C5001,5005-5010,5014,5021,5023,5026,5029-5032,5035,5037,5041-5043,5055,5057,5061,5062,5064,5065,5067-5069,5073-5075,5080,5082,5083,5085,5087,5091,5092,5094-5098,5100,5102,5106	K13179008	"	" " F 0.01μF (DD106F103Z50V)
R5019	J01245100	" " " " 10Ω	<p style="text-align: center;">FOR SERVICE MANUALS CONTACT: MAURITRON TECHNICAL SERVICES www.mauritron.co.uk TEL: 01844 - 351694 FAX: 01844 - 352554</p>			
R5044	J02245220	" " " " SJ 22Ω				
R5007,5018,5024,	J02245560	" " " " 56Ω				
R5016,5021,5023,5059	J01245560	" " " TJ 56Ω				
R5005,5031,5022	J02245101	" " " " SJ 100Ω				
R5013,5055	J02245151	" " " " 150Ω				
R5042,5047	J02245221	" " " " 220Ω				
R5002,5060	J01215102	" " 1/8W TJ 1kΩ				
R5006,5025,5040,5043,5050,5051,5056,5062	J02245102	" " 1/4W SJ 1kΩ				
R5046	J02245122	" " " " 1.2kΩ				
	J01215152	" " 1/8W TJ 1.5kΩ				
R5020,5022	J02245222	" " 1/4W SJ 2.2kΩ				
R5064,5065	J02245682	" " " " 6.8kΩ (50MHz UNIT)				
R5041	J02245822	" " " " 8.2kΩ				
R5015,5038,5049	J02245103	" " " " 10kΩ				
R5037	J01245103	" " " TJ 10kΩ				
R5036	J02245223	" " " SJ 22kΩ				
R5003,5011,5012,5027,5028	J02245473	" " " " 47kΩ				
R5001,5008-5010,5014,5029,5030,5032-5034,5039,5057,5058	J02245104	" " " " 100kΩ				
R5035	J01245104	" " " TJ 100kΩ				
R5004	J02245225	" " " SJ 2.2MΩ				
			TRIMMER CAPACITOR			
VR5003	J51745471	H0651A005-470B 470Ω(B)	TC5001	K91000028	ECV-1ZW 10x53	10pF
VR5004	J51745103	H0651A013-10KB 10kΩ(B)	TC5002	K91000017	ECV-1ZW 70x32	70pF
VR5006	J51745223	H0651A015-22KB 22kΩ(B)	INDUCTOR			
VR5005	J51745473	H0651A017-47KB 47kΩ(B)	L5001	L1190009	FL4H-3R3M	3.3μH
			L5002,5003	L1190138	LAL04NA100K	10μH
			L5004	L1190014	FL4H-100K	10μH
			L5005	L1020680		
			L5006	L0020340		

(50MHz MODULE)

L5007	L1020673		Q6013	G3304600B	2SC460B
L5008	L1020683		Q6017	G3305350B	2SC535B
L5009	L0020724		Q6006,6007, 6010-6012, 6014,6015,6018, 6020,6026,6029, 6030	G3309451P	2SC945AP
		TRANSFORMER			
T5001-5005, 5011,5012-5015	L0020825		Q6022,6031	G3408920Q	2SD892Q
T5006,5007	L0021162				
T5008-5010	L0021161				DIODE
			D6003, 6005-6010, 6012-6015, 6017,6018,6021, 6023,6025	G2090027	Si 1SS53
		RELAY			
RL5001	M1190006	FBR221D012M			
			D6001,6002,6004	G2090023	Varactor 1SV50
			D6011,6016	G2090003	Si V06B
		CONNECTOR			
J5003	P0090041	5048-03A			THERMISTOR
J5004	P0090042	5048-05A	TH6001	G9090008	31D26
J5001	P0090051	5048-06A			
J5002	P0090189	5049-11A			CRYSTAL
J5005,5006	P1090255	TMP-JA	X6001	H0102509	HC-18/U-3P 27.4035MHz
			X6002	H0102338	HC-18/U 6.4MHz
					RESISTOR
			R6005,6007,6014, 6018,6019,6024, 6051	J02245560	Carbon film 1/4W SJ 56Ω
*** 50MHz PLL UNIT ***					
Symbol No.	Part No.	Description	R6003	J00245101	" " 1/8W VJ 100Ω
		PLL BOARD	R6012,6040,6045, 6050,6057	J02245101	" " 1/4W SJ 100Ω
PB-2447A	F0002447A	Printed Circuit Board			
	C024470A	PCB with Components (w/VCO Board) Model F	R6053,6086	J01245101	" " " TJ 100Ω
	C024470B	" Model A	R6083	J01215101	" " 1/8W " 100Ω
			R6031	J02245221	" " 1/4W SJ 220Ω
			R6002,6085	J02245331	" " " " 330Ω
		VCO BOARD		J01245471	" " " TJ 470Ω
PB-2442	F0002442	Printed Circuit Board	R6084	J02245561	" " " SJ 560Ω
	C024420A	PCB with Q6001,D6001-6003, R6001-6003,TH6001,C6001- 6004,6006-6013,TC6002, L6001-6006	R6020,6027	J02245681	" " " " 680Ω
			R6025,6041,6044, 6046,6049,6056	J02245102	" " " " 1kΩ
			R6039	J02245122	" " " " 1.2kΩ
			R6015,6029,6032, 6033,6052	J02245222	" " " " 2.2kΩ
		IC	R6021	J02245332	" " " " 3.3kΩ
Q6021	G1090342	MB84024B	R6063	J02245392	" " " " 3.9kΩ
Q6023	G1090053	MC14081B	R6009,6026,6036	J02245472	" " " " 4.7kΩ
Q6025	G1090343	MC14094B	R6034	J01245472	" " " TJ 4.7kΩ
Q6028	G1090312	MC14504B	R6028,6043,6048, 6055	J02245562	" " " SJ 5.6kΩ
Q6024	G1090298	MC14560B			
Q6005	G1090012	SN16913P	R6060,6072	J02245103	" " " " 10kΩ
Q6016	G1090062	SN76514N	R6035,6037,6038, 6042,6047,6054, 6061,6062,6066, 6073,6076,6080, 6081	J02245223	" " " " 22kΩ
Q6009	G1090473	TC5081AP			
Q6008	G1090247	TC9122P			
Q6027	G1090084	μPC78L05			
Q6032	G1090294	μPC7808H	R6082	J01215223	" " 1/8W TJ 22kΩ
			R6030	J02245273	" " 1/4W SJ 27kΩ
			R6087	J01215393	" " 1/8W TJ 39kΩ
		FET	R6010,6011	J02245473	" " " " 47kΩ
Q6002,6004	G3802410Y	2SK241Y	R6071	J02245563	" " " " 56kΩ
Q6001	G3801921G	2SK192AGR			
Q6003	G4800730Y	3SK73Y	R6004,6008,6013, 6016,6023,6058, 6059,6064,6065, 6067-6070, 6074,6079	J02245104	" " " " 100kΩ
		TRANSISTOR	R6075	J01245104	" " " TJ 100kΩ
Q6019	G3105641	2SA564A	R6077,6078	J02245224	" " " SJ 220kΩ

(50MHz MODULE)

R6022	J02245334	Carbon film 1/4W SJ 330kΩ	C6028-6031, 6045,6046, 6050-6052, 6067-6069, 6071,6073,6080, 6082,6084,6095, 6104,6106-6113	K13179008	Ceramic 50WV F 0.01μF (DD106F103Z50V)
R6001	J02245474	" " " " 470kΩ			
		BLOCK RESISTOR			
RB6001	J40900022	DA-1			
RB6002	J40900023	DA-2			
		CAPACITOR			
C6055	K00179001	Ceramic 50WV SL 0.5pF (DD104SL0R5C50V)	C6038,6042,6058, 6059, 6061-6065,6094, 6114	K19149021	Semiconductor Ceramic 25WV 0.047μF (UAT-08X473K-L45AE)
C6017,6018	K00172010	" " " " 1pF (DD104SL010C50V)	C6044	K54200001	Polycarbonate 100WV 1μF (B32561A1105J)
C6014,6077	K02179003	" " " CH 2pF (DD104CK020C50V)	C6088	K70167474	Tantalum 35WV 0.47μF (CS15E1VR47M)
C6085	K00172020	" " " SL 2pF (DD104SL020C50V)	C6066	K70140007	" 25WV 1μF (489D105X0025A1)
C6056	K00172040	" " " " 4pF (DD104SL040C50V)	C6043	K70120006	" 16WV 3.3μF (489D335X0016B1)
C6076	K02173060	" " " CH 6pF (DD104CH060D50V)	C6087	K70120002	" " 10μF (489D106X0016C1)
C6027	K00173080	" " " SL 8pF (DD104SL080J50V)	C6091,6105	K40179002	Electrolytic 50WV 0.1μF (ECE-A1HK-0R1)
C6012	K06173080	" " " UJ 8pF (DD104UJ080D50V)	C6098	K40179001	" " 1μF (ECE-A1HK-010)
C6003	K06175150	" " " " 15pF (DD104UJ150J50V)	C6089,6101,6102	K40149011	" 25WV 4.7μF (ECE-A1EK4R7)
C6008	K02175150	" " " CH 15pF (DD104CH150J50V)	C6039,6103	K40129012	" 16WV 10μF (ECE-A1CK100)
C6083	K05175150	" " " RH 15pF (DD104RH150J50V)	C6010	K40109001	" 10WV 100μF (10RE100)
C6078,6079,6086	K05175180	" " " " 18pF (DD104RH180J50V)			TRIMMER CAPACITOR
C6053,6054	K05175220	" " " " 22pF (DD104RH220J50V)	TC6002	K91000055	ECV1ZW 06x53N 6pF
C6004	K02175270	" " " CH 27pF (DD104CH270J50V)	TC6003	K91000029	ECV1ZW 20x53 20pF
C6011	K06175270	" " " UJ 27pF (DD104UJ270J50V)			INDUCTOR
C6007	K02175330	" " " CH 33pF (DD104CH330J50V)	L6008	L1020680	
C6032,6035	K00175330	" " " SL 33pF (DD104SL330J50V)	L6013	L1190089	LAL04NA1R0M 1μH
C6092	K06175330	" " " UJ 33pF (DD104UJ330J50V)	L6006	L1190143	FL3H-3R3M 3.3μH
C6048,6049	K06175470	" " " " 47pF (DD104UJ470J50V)	L6014	L1190009	FL4H-3R3M 3.3μH
C6057,6060,6081	K00175470	" " " SL 47pF (DD104SL470J50V)	L6001-6004	L1190110	FL3H-4R7K 4.7μH
C6047	K06179009	" " " UJ 56pF (DD105UJ560J50V)	L6009,6010	L1190014	FL4H-100K 10μH
C6034,6075	K00175680	" " " SL 68pF (DD104SL680J50V)	L6015	L1190025	FL5H-330K 33μH
C6021	K06185820	" " " UJ 82pF (RD871-1N750-820J63V)	L6012	L1190017	FL5H-102K 1mH
C6099	K00175101	" " " " 100pF (DD105SL101J50V)			TRANSFORMER
C6093,6096	K00175151	" " " " 150pF (DD106SL151J50V)	T6001	L0020825	
C6001,6002,6006, 6013,6019,6033, 6036,6037,6040, 6041,6070,6072, 6074,6090,6097	K10176102	" " " B 0.001μF (DD104B102K50)	T6002	L0021352	
C6009,6015,6016, 6020, 6023-6026	K13179008	" " " F 0.01μF (DD106F103Z50V)	T6003,6004	L0020919	
			T6005,6006	L0020782	
			T6007	L0190013	
			T6008-6011	L0190011	
					RELAY
			RL6001	M1190002	FBR211AD012M
					CONNECTOR
			J6004	P0090041	5048-3A
			J6002	P0090097	5049-5A
			J6003	P0090051	5048-6A
			J6001	P0090100	5049-12A

(50MHz MODULE)

		TP TERMINAL	P7003(with wire)	T9307002	
	Q5000036	TP-G			
	Q5000020	MS-60121			
					TP TERMINAL
				Q5000036	TP-G
*** 50MHz PA UNIT ***					
Symbol No.	Part No.	Description	144MHz MODULE		
PB-2451	F0002451	Printed Circuit Board	*** 144MHz RF UNIT ***		
	C024510A	PCB with Components	Symbol No.	Part No.	Description
			PB-2452	F0002452	Printed Circuit Board
				C024520A	PCB with Components
					FET
		DIODE	Q5003,5011	G3801250	2SK125
D7002	G2015880	Si 1S1588	Q5004,5005	G3802410Y	2SK241Y
D7001	G2090003	" V06B	Q5002	G4800510C	3SK51-03
			Q5006	G4800700	3SK70
			Q5001	G4800740L	3SK74L
		RESISTOR			
R7003	J30356019	Cement 3W 0.1Ω			
R7004	J02245222	Carbon film 1/4W 2.2kΩ			
					TRANSISTOR
		CAPACITOR	Q5008	G3107331Q	2SA733AQ
C7015	K02179003	Ceramic 50WV CH2pF (DD104CK020C50V)	Q5007	G3325380	2SC2538
C7011	K02175120	" " " 12pF (DD104CH120J50V)	Q5009,5010	G3404710L	2SD471L
					DIODE
C7029	K00175330	" " SL 33pF (DD104SL330J50V)	D5013	G2015550	Si 1S1555
C7013,7016-7018	K00175470	" " SL 47pF (DD104SL470J50V)	D5007-5008, 5014-5015,5018, 5020	G2090027	" 1SS53
C7012,7026	K00175560	" " " 56pF (DD104SL560J50V)	D5016	G2090118	Schottky Barrier 1SS97
C7014	K00175101	" " " 100pF (DD105SL101J50V)	D5002-5006, 5009-5012	G2090107	Varactor 1T25
C7001-7003, 7005,7007,7009, 7010,7019,7020	K10176102	" " B 0.001μF (DD104B102K50)	D5001	G9090006	Varistor MV13
C7021-7025	K21170002	Feed through 0.001μF (ECKY1H-102WE)	D5019	G2090003	Si V06B
C7004,7006,7008	K40129012	Electrolytic 16WV 10μF (16RC2-10)	D5017	G2090218	Zener HZ9C1
					THERMISTOR
			TH5001	G9090013	25D29
			TH5002	G9090008	31D26
			TH5003	G9090002	D22A
			TH5004	G9090001	SDT250
		INDUCTOR			
L7001	L1020673				CRYSTAL FILTER
L7002	L1020663		XF5001	H1102021	108M30B
L7004-7006	L0020824				
L7003	L0020679				
					RESISTOR
		RELAY	R5047,5048	J01245229	Carbon film 1/4W TJ 2.2Ω
RL7001	M1190006	FBR221D012M	R5019	J01245100	" " " 10Ω
			R5003,5005,5013, 5018,5023	J02245560	" " " SJ 56Ω
		CONNECTOR	R5016,5021,5025	J01245560	" " " TJ 56Ω
J7001	P1090192	FM-MR	R5039	J01215560	" " 1/8W " 56Ω
J7002	P1090005	SG-8050	R5030	J02245101	" " 1/4W SJ 100Ω
			R5041	J01215101	" " 1/8W TJ 100Ω
			R5049	J02245151	" " 1/4W SJ 150Ω
			R5024	J02245271	" " " " 270Ω
P7001(with wire)	T9204523		R5038	J01215331	" " 1/8W TJ 330Ω
P7002(")	T9307001		R5051	J01215102	" " " " 1kΩ

(50MHz MODULE)

(144MHz MODULE)

R5004,5044,5045	J02245102	Carbon film 1/4W SJ 1kΩ	C5065,5071,5087, 5088,5097	K13179008	Ceramic 50WV F 0.01μF (DD106F103Z50V)
R5040	J01215122	" " 1/8W TJ 1.2kΩ			
R5050	J01215152	" " " " 1.5kΩ	C5021,5059	K40179013	Electrolytic " 1μF (50RE1)
R5020,5046	J02245222	" " 1/4W SJ 2.2kΩ			
R5015,5037,5043	J02245103	" " " " 10kΩ	C5038	K40129004	" 16WV 10μF (16RE10)
R5036	J01215103	" " 1/8W TJ 10kΩ			
R5035	J02245223	" " 1/4W SJ 22kΩ	C5069,5072,5086	K40129012	" " 10μF (16RC2-10)
R5001,5011,5012, 5026,5027	J02245473	" " " " 47kΩ			
R5009,5022	J01245473	" " " TJ 47kΩ	C5085	K40109001	" 10WV 100μF (10RE100)
R5006-5008, 5010,5014,5028, 5029,5031-5033	J02245104	" " " SJ 100kΩ	C5080	K40129019	" 16WV 1000μF (16RC1000)
R5034	J01215104	" " 1/8W TJ 100kΩ			
R5002	J02245225	" " 1/4W SJ 2.2MΩ			TRIMMER CAPACITOR
		BLOCK RESISTOR	TC5001	K91000028	ECV-1ZW 10x53T 10pF
RB6002	J40900023	DA-2	TC5002	K91000029	ECV-1ZW 20x53T 20pF
		POTENTIOMETER			
VR5003	J51745102	H0651A007-1KB 1kΩB			INDUCTOR
VR5004	J51745103	H0651A013-10KB 10kΩB	L5002,5003	L1190089	LAL04NA1R0M 1μH
VR5006	J51745223	H0651A015-22KB 22kΩB	L5001	L1190004	FL4HR68M 0.68μH
VR5005,5006	J51745473	H0651A017-47KB 47kΩB	L5004	L0021355	
		CAPACITOR	L5005,5008	L0021356	
C5017	K02182059	Ceramic 63WV CH 0.5pF (RD870-1NPO-0R5C63V)	L5006	L1020673	
C5012,5024,5054, 5061	K02179001	" 50WV " 1pF (DD104CK010C50V)	L5007	L0021357	
C5015,5019,5030, 5049,5052,5056	K02179003	" " " 2pF (DD104CK020C50V)			TRANSFORMER
C5009	K02172040	" " CH 4pF (DD104CH040C50V)	T5001	L0021353	
C5011,5016,5018, 5025	K05173080	" " RH 8pF (DD104RH080D50V)	T5002-5006, 5012-5015	L0020907	
C5053,5055,5062	K02173080	" " CH 8pF (DD104CH080D50V)	T5007,5008-5010	L0021162	
C5002	K02173100	" " " 10pF (DD104CH100D50V)	T5011	L0021161	
C5029	K05173100	" " RH 10pF (DD104RH100J50V)			CONNECTOR
C5003,5051,5057, 5074	K02175120	" " CH 12pF (DD104CH120J50V)	J5001	P0090051	5048-06A
C5014,5023	K05175120	" " RH 12pF (DD104RH120J50V)	J5002	P0090189	5049-11A
C5047,5048	K02175150	" " CH 15pF (DD104CH150J50V)	J5003	P0090041	5048-03A
C5026	K02179009	" " " 22pF (DD104CH220J50V)	J5004	P0090042	5048-05A
C5063	K00175470	" " SL 47pF (DD104SL470J50V)	J5005,5006	P1090255	TMP-JA
C5075,5103	K02175470	" " CH 47pF (DD106CH470J50V)			
C5067	K02175560	" " " 56pF (DD106CH560J50V)			RELAY
C5001,5064, 5066,5068,5070	K10176102	" " B 0.001μF (DD104B102K50)	RL5001	M1190006	FBR221D012M
C5005,5013, 5027,5031,5036, 5040,5040,5058, 5076-5079, 5081-5084, 5089-5096,5098	K12171102	" " E 0.001μF (DD104E102P50V)			FERRITE BEADS
C5004,5006,5008, 5010,5020,5022, 5028, 5032-5034, 5037,5039, 5044-5046,5060	K13179008	" " F 0.01μF (DD106F103Z50V)	FB5001	L9190001	Ri 3x3-1
			*** 144MHz PLL UNIT ***		
			Symbol No.	Part No.	Description
			PB-2447A	F0002447A	Printed Circuit Board
				C024471A	PCB with Components (w/VCO Board) Model A
				C024471B	" Model X
				C024471C	" Model B
				C024471D	" Model C
				C024471E	" Model D
				C024471F	" Model E
				C024471G	" Model F

(144MHz MODULE)

PB-2442	F0002442	Printed Circuit Board	R6031	J02245221	Carbon film 1/4W SJ 220Ω
	C024421A	PCB with Q6001,D6001-- D6003,R6000-R6003,TH6001, C6001-C6013,TC6001,6002, L6001-L6006	R6002	J02245331	" " " " 330Ω
			R6085	J02245331	" " " " 330Ω
			R6086	J01245471	" " " TJ 470Ω
			R6020,6027	J02245681	" " 1/4W SJ 680Ω
			R6025,6041,6044, 6046,6049,6056	J02245102	" " " " 1kΩ
		IC	R6015,6029,6032, 6033,6052	J02245222	" " " " 2.2kΩ
Q6021	G1090342	MB84024B	R6039	J02245272	" " " " 2.7kΩ
Q6023	G1090053	MC14081B	R6021	J02245332	" " " " 3.3kΩ
Q6025	G1090343	MC14094B	R6063	J02245392	" " " " 3.9kΩ
Q6028	G1090312	MC14504B	R6009,6026,6036	J02245472	" " " " 4.7kΩ
Q6024	G1090298	MC14560B	R6034	J01245472	" " " TJ 4.7kΩ
Q6005	G1090012	SN16913P	R6028,6043,6048, 6055	J02245562	" " " SJ 5.6kΩ
Q6016	G1090062	SN76514N	R6060,6072	J02245103	" " " " 10kΩ
Q6009	G1090473	TC5081AP	R6035,6037,6038, 6042,6047,6054, 6061,6062,6066, 6073,6076,6080, 6081	J02245223	" " " " 22kΩ
Q6008	G1090247	TC9122P	R6082	J01215223	" " 1/8W TJ 22kΩ
Q6027	G1090084	μPC78L05	R6030	J02245273	" " 1/4W SJ 27kΩ
Q6032	G1090294	μPC7808H	R6087	J01215393	" " 1/8W TJ 39kΩ
		FET	R6010,6011	J02245473	" " " SJ 47kΩ
Q6001	G3801921G	2SK192AGR	R6071	J02245563	" " " " 56kΩ
Q6002,6004	G3802410Y	2SK241Y	R6004,6008,6013, 6016,6023,6058, 6059,6064,6065, 6067-6070, 6074,6079	J02245104	" " " " 100kΩ
Q6003	G4800730Y	3SK73Y	R6075	J01245104	" " " TJ 100kΩ
		TRANSISTOR	R6077,6078	J02245224	" " " SJ 220kΩ
Q6019	G3105641	2SA564A	R6022	J02245334	" " " " 330kΩ
Q6013	G3304600B	2SC460B	R6001	J02245474	" " " " 470kΩ
Q6017	G3305350B	2SC535B			BLOCK RESISTOR
Q6006,6007, 6010-6012, 6014,6015,6018, 6020,6026,6029, 6030	G3309451P	2SC945AP	RB6001	J40900022	DA-1
Q6022,6031	G3408920Q	2SD892Q			CAPACITOR
		DIODE	C6055,6077,6085	K00179001	Ceramic 50WV SL 0.5pF (DD104SL0R5C50V)
D6003, 6005-6010, 6012-6015, 6017,6018, 6018-6020, 6024-6026	G2090027	Si 1SS53	C6017,6018,6027	K00172010	" " " " 1pF (DD104SL010C50V)
D6001,6002,6004	G2090107	Varactor 1T25	C6007,6022	K02179003	" " CH 2pF (DD104CK020C50V)
D6011,6016	G2090003	Si V06B	C6002,6003	K06172040	" " UJ 4pF (DD104UJ040J50V)
		CRYSTAL	C6074	K02172040	" " CH 4pF (DD104CH040C50V)
X6001	H0102508	HC-18/U3P 60.7018MHz	C6004,6012,6014	K02172050	" " " 5pF (DD104CH050C50V)
X6002	H0102338	HC-18/U 6.4MHz	C6005	K02173070	" " " 7pF (DD104CH070D50V)
		THERMISTOR	C6008	K02173080	" " " 8pF (DD104CH080D50V)
TH6001	G9090008	31D26	C6021,6075,6078, 6079,6083,6086	K05173100	" " RH 10pF (DD104RH100D50V)
		RESISTOR	C6076	K02173100	" " CH 10pF (DD104CH100D50V)
R6005,6007,6014, 6018,6019,6024, 6051	J02245560	Carbon film 1/4W SJ 56Ω	C6053,6054	K05175120	" " RH 12pF (DD104RH120J50V)
R6003	J00215101	" " 1/8W VJ 100Ω	C6011	K06175150	" " UJ 15pF (DD104UJ150J50V)
R6015,6040,6045, 6050,6057	J02245101	" " 1/4W " 100Ω	C6032,6035,6081	K00175330	" " SL 33pF (DD104SL330J50V)
R6053	J01245101	" " " TJ 100Ω			
R6083	J01215101	" " 1/8W " 100Ω			

(144MHz MODULE)

C6048,6092	K06175330	Ceramic 50WV UJ 33pF (DD104UJ330J50V)	T6001,6003,6004, 6007-6011	L0020907	TRANSFORMER
C6049	K06175470	" " " 47pF (DD104UJ470J50V)	T6002	L0020533	
C6057,6060	K00175470	" " SL 47pF (DD104SL470J50V)	T6005,6006	L0020782	
C6034	K00175680	" " " 68pF (DD104SL680J50V)			RELAY
C6099	K00175101	" " " 100pF (DD105SL101J50V)	RL6001	M1190002	FBR211AD012M
C6093,6096	K00175151	" " " 150pF (DD106SL151J50V)			CONNECTOR
C6001,6006,6013	K10176102	" " B 0.001μF (DD104B102K50V)	J6004	P0090041	5048-03A
			J6002	P0090097	5049-05A
C6019,6033,6036, 6037,6040,6041, 6056,6070,6072, 6090,6097,6112, 6113	K12171102	" " E 0.001μF (DD104E102P50V)	J6003	P0090051	5048-06A
			J6001	P0090100	5049-12A
C6009,6015,6016, 6020, 6023-6026, 6028-6031, 6045,6046, 6050-6052, 6067-6069, 6071,6073,6080, 6082,6084,6095, 6104,6106-6111 6115	K13179008	" " F 0.01μF (DD106F103Z50V) FOR SERVICE MANUALS CONTACT: MAURITRON TECHNICAL SERVICES www.mauritron.co.uk TEL: 01844 - 351694 FAX: 01844 - 352554		Q5000036	TP TERMINAL TP-G
			*** 144MHz PA UNIT ***		
			Symbol No.	Part No.	Description
C6038,6042,6058, 6059, 6061-6065,6094, 6114	K19149021	Semiconductor Ceramic 25WV 0.047μF (UAT-08X473K-L45AE)	PB-2451	F0002451	Printed Circuit Board
				C024511A	PCB with Components
C6044	K54200001	Polycarbonate 100WV 1μF (B32561A1105J)			POWER MODULE
C6088	K70167474	Tantalum 35WV 0.47μF (CS15E1VR47M)	Q7001	G1090295	M57713
C6066	K70140007	" 25WV 1μF (489D105X0025A1)			DIODE
C6043	K70120006	" " 3.3μF (489D335X0016B1)	D7002	G2090118	Schottky barrier 1SS97
			D7001	G2090003	Si V06B
C6087	K70120002	" 16WV 10μF (489D106X0016C1)			
C6091,6105	K40179002	Electrolytic 50WV 0.1μF (ECE-A1HK0R1)			RESISTOR
C6098,6100	K40179001	" " 1μF (ECE-A1HK1R0)	R7003	J30356019	Cement 3W 0.1Ω
			R7004	J02245222	Carbon film 1/4W SJ 2.2kΩ
C6089,6101,6102	K40149011	" 25WV 4.7μF (ECE-A1EK4R7)			CAPACITOR
C6039,6103	K40129012	" 16WV 10μF (ECE-A1CK100)	C7015	K02179003	Ceramic 50WV CH 2pF (DD104CK020C50V)
C6010	K40109001	" 10WV 100μF (10RE100)	C7012,7013, 7016-7018	K02175150	" " " 15pF (DD104CH150J50V)
		TRIMMER CAPACITOR	C7011	K02175180	" " " 18pF (DD104CH180J50V)
TC6001,6002	K91000056	ECV1ZW 06x53T 6pF			
TC6003	K91000029	ECV-1ZW 20x53T 20pF	C7014	K02179012	" " " 30pF (DD105CH300J50V)
		INDUCTOR	C7001-7003, 7005,7007,7009, 7010,7019,7020	K10176102	" " B 0.001μF (DD104B102K50V)
L6006	L1190108	FL3H-R68M 0.68μH			
L6014	L1190004	FL4H-R68M 0.68μH			
L6001-6004	L1190129	FL3H1R0M 1μH	C7021-7025	K21170002	Feed thru " 0.001μF (ECKY1H-102WE)
L6013	L1190089	LAL04NA1R0M 1μH			
L6009,6010	L1190014	FL4H-100K 10μH	C7026,7027	K13179009	Ceramic 50WV F0.047μF (DD110F473Z50V)
L6015	L1190025	FL5H-330K 33μH			
L6012	L1190017	FL5H-102K 1mH	C7004,7006,7008	K40129012	Electrolytic 16WV 10μF (16RC2-10)
L6007,6008	L1020680				

(144MHz MODULE)

		INDUCTOR	D5007,5014	G2090118	Schottky Barrier 1SS97	
L7001	L1020673		D5010,5011	G2090033	PIN MI301	
L7002	L1020663		D5009	G2090003	Si V06B	
L7003	L0020678					
L7004-7006	L0020679					
					CRYSTAL	
			X5001	H0102507	HC-18/U3P 56.805MHz	
		RELAY				
RL7001	M1190006	FBR221D012M				
					THERMISTOR	
			TH5001,5002	G9090008	31D26	
		CONNECTOR	TH5003	G9090001	SDT250	
J7001	P1090192	FM-MR				
J7002	P1090005	SG8050			CRYSTAL FILTER	
			XF5001	H1102072	XF-67JX 67.615MHz	
		PLUG			RESISTOR	
P7001 (with wire)	T9204523		R5007,5033	J01215150	Carbon film 1/8W TJ 15Ω	
			R5014,5018, 5021,5022 5026,5037,5058, 5062,5063	J02245560	" " 1/4W SJ 56Ω	
		TP TERMINAL				
	Q5000036	TP-G				
	Q5000020	MS-60121	R5023	J01245560	" " " TJ 56Ω	
			R5019	J01215560	" " 1/8W TJ 56Ω	
		CONNECTION CABLE	R5043	J01215680	" " " " 68Ω	
P7505	T9204527A		R5022,5052	J02245101	" " 1/4W SJ 100Ω	
P7506	T9204527A		R5031	J01215101	" " 1/8W TJ 100Ω	
P7507	T9204529A		R5001,5013	J02245151	" " 1/4W SJ 150Ω	
			R5002,5067,5068	J00215151	" " 1/8W VJ 150Ω	
			R5006,5034	J01215271	" " " TJ 270Ω	
			R5017	J02245271	" " 1/4W SJ 270Ω	
			R5041,5065	J01215331	" " 1/8W TJ 330Ω	
			R5008,5032	J01215561	" " " " 560Ω	
			R5044	J02245681	" " 1/4W SJ 680Ω	
			R5053	J01215681	" " 1/8W TJ 680Ω	
			R5047,5048,5061	J02245102	" " 1/4W SJ 1kΩ	
			R5070,5073	J01215102	" " 1/8W TJ 1kΩ	
			R5042	J02245122	" " 1/4W SJ 1.2kΩ	
			R5066,5038	J00215152	" " 1/8W VJ 1.5kΩ	
		TRANSISTOR	R5012,5072	J02245152	" " 1/4W SJ 1.5kΩ	
Q5013	G3107331Q	2SA733AQ	R5020,5049,5057, 5064	J02245222	" " " " 2.2kΩ	
Q5015,5016	G3304600B	2SC460B		J01215272	" " 1/8W TJ 2.7kΩ	
Q5012	G3314260	2SC1426				
Q5014	G3320260	2SC2026	R5054	J02245472	" " 1/4W SJ 4.7kΩ	
Q5011	G3324070	2SC2407	R5060	J02245562	" " " " 5.6kΩ	
			R5046	J02245103	" " " " 10kΩ	
			R5009,5028,5059,	J02245223	" " " " 22kΩ	
		FET	R5015,5016,5024, 5025,5030,5055, 5056	J02245473	" " " " 47kΩ	
Q5002,5010	G3801250	2SK125				
Q5006,5007	G3802410Y	2SK241Y				
Q5005	G4800510C	3SK51-03	R5029	J01215473	" " 1/8W TJ 47kΩ	
Q5004,5008	G4800730Y	3SK73Y	R5071	J01215563	" " " " 56kΩ	
Q5001	G4801210	3SK121	R5010	J02245104	" " 1/4W SJ 100kΩ	
			R5027	J01215104	" " 1/8W TJ 100kΩ	
			R5011	J02245225	" " 1/4W SJ 2.2MΩ	
		QUAD DIODE				
Q5003	G2090247	ND487C1-3R			POTENTIOMETER	
Q5009	G2090135	ND487C2-3R	VR5003	J51745102	H0651A007-1KB 1kΩB	
			VR5004	J51745103	H0651A013-10KB 10kΩB	
			VR5006	J51745223	H0651A015-22KB 22kΩB	
			VR5005	J51745473	H0651A017-47KB 47kΩB	
		DIODE				
D5004,5005	G2015550	Si 1S1555				
D5001-5003, 5006,5008,5012, 5013	G2090027	" 1SS53			CAPACITOR	
			C5010	K00172010	Ceramic 50WV SL 1pF (DD104SL010C50V)	

(144MHz MODULE)

(430 MHz MODULE)

C5024	K00172020	" " " 2pF (DD104SL020C50V)	L5003,5005,5008, 5009,5011,5018, 5020	L1020673	
	K02179003	" " " CH 2pF (DD104CK020C50V)	L5004,5010,5015 5019	L0021359	
C5006,5009,5045, 5047,5076	K02179004	" " " 3pF (DD104CH030C50V)	L5013	L1020672	
C5001	K02172040	" " " 4pF (DD104CH040C50V)	L5014	L0020903	
C5048	K02173070	" " " 7pF (DD104CH070D50V)	L5016	L0020474	
C5029,5030,5052	K02173080	" " " 8pF (DD104CH080D50V)	L5017	L0020900	
C5002	K02173090	" " " 9pF (DD104CH090D50V)	L5024	L0020342	
C5018,5070,5071	K02173100	" " " 10pF (DD104CH100D50V)			CAVITY
C5022	K00173100	" " SL 10pF (DD104SL100D50V)	CV5004	Q9000214	CV370
C5034	K00175120	" " SL 12pF (DD104SL120J50V)	CV5001-5003	Q9000114B	CV441B
C5021,5084	K05175150	" " RH 15pF (DD104RH150J50V)			TRANSFORMER
C5079	K06175330	" " UJ 33pF (DD104UJ330J50V)	T5001,5002,5012, 5013	L0190007	
	K00175330	" " SL 33pF (DD104SL330J50V)	T5003,5004, 5009-5011	L0021165	
C5005,5008,5014, 5035,5044,5074	K00175470	" " SL 47pF (DD104SL470J50V)	T5005,5015	L0021358	
C5080	K06175470	" " UJ 47pF (DD104UJ470J50V)	T5006-5008	L0021161	
C5003,5004,5007, 5025,5019,5026, 5028, 5039-5043, 5049,5050,5053, 5055,5056,5059, 5061-5064, 5066-5068, 5072,5073,5075, 5078,5082, 5089-5092, 5094,5095,5098	K12171102	" " E 0.001μF (DD104E102P50V)	T5014	L0020533	
C5012,5013, 5015-5017, 5020,5023,5025, 5027, 5031-5033, 5036-5038, 5057,5060,5069, 5081,5083, 5085-5087, 5093,5097	K13179008	" " F 0.01μF (DD106F103Z50V)			RELAY
C5099,5101	K23170020	Chip " 0.001μF (GR40W5R102M50V)	RL5001	M1190006	FBR221D012M
CS051,5054,5058, 5096	K40129012	Electrolytic 16WV 10μF (16RC2-10)			CONNECTOR
C5065	K40129019	" " 1000μF (16RC1000)	J5003	P0090041	5048-03A
		TRIMMER CAPACITOR	J5001	P0090054	5048-07A
TC5001	K91000060	ECV-1ZW 02x53 2pF	J5002	P0090189	5049-11A
TC5002	K91000059	ECV-1ZW 04x53 4pF	J5004-5007	P1090255	TMP-JA
TC5003	K91000055	ECV-1ZW 06x53N 6pF			TP TERMINAL
		INDUCTOR		Q5000016	TP-G
L5023	L1190004	FL4H-R68M 0.68μH			*** 430MHz PLL UNIT ***
L5006,5007,5012	L1190089	LAL04NA1R0M 1μH	Symbol No.	Part No.	Description
L5001	L0020472		PB-2446A	F0002446A	Printed Circuit Board
L5002,5021,5025	L0020852			C024460A	PCB with Components (w/VCO Board) Model A
				C024460B	" " B
				C024460C	" " C
				C024460D	" " X
				C024460E	" " F
			PB-2442A	F0002442	Printed Circuit Board
				C002442A	PCB with Q6001,D6001,6002, 6018-6025,TH6001,R6001- 6003,C6001-6010,TC6001, L6001-6004
					IC
			Q6030	G1090053	MC14081B
			Q6028	G1090343	MC14094B
			Q6029	G1090312	MC14504B
			Q6016	G1090496	MC145143P
			Q6005,6014	G1090012	SN16913P

(430MHz MODULE)

Q6010	G1090473	TC5081AP		R6062,6067	J02245102	Carbon film	1/4W SJ	1kΩ	
Q6009	G1090239	TC5082P		R6037	J02245182	" "	" "	1.8kΩ	
Q6008,6023	G1090247	TC9122P		R6009,6064	J02245222	" "	" "	2.2kΩ	
Q6027	G1090084	μPC78L05		R6021	J02245332	" "	" "	3.3kΩ	
Q6033	G1090294	μPC7808H		R6026,6028,6029, 6034,6043,6045	J02245472	" "	" "	4.7kΩ	
				R6056,6061	J02245561	" "	" "	5.6kΩ	
		FET		R6008,6030,6032	J02245103	" "	" "	10kΩ	
Q6001,6017	G3801921G	2SK192AGR		R6084	J02245153	" "	" "	15kΩ	
Q6002,6004,6018, 6019	G3802410Y	2SK241Y		R6035,6036,6055, 6060, 6068-6070, 6078,6079,6082	J02245223	" "	" "	22kΩ	
				R6021	J01215223	" "	1/8W TJ	22kΩ	
		TRANSISTOR		R6086	J01215393	" "	" "	39kΩ	
Q6011	G3107331Q	2SA733AQ		R6087	J00215473	" "	" "	47kΩ	
Q6013	G3304600B	2SC460B		R6083	J02245563	" "	1/4W SJ	56kΩ	
Q6006,6007,6012, 6015, 6020-6022, 6024,6025,6032	G3309451P	2SC945AP		R6004,6015,6031, 6033,6049,6051, 6073,6076,6077, 6080,6081	J02245104	" "	" "	100kΩ	
Q6003	G3320260	2SC2026		R6072	J01245104	" "	" TJ	100kΩ	
Q6026,6031	G3408920Q	2SD892Q		R6022,6040,6065, 6074,6075	J02245224	" "	" SJ	220kΩ	
				R6020	J02245334	" "	" "	330kΩ	
		DIODE		R6001	J02245474	" "	" "	470kΩ	
D6003,6004, 6006-6009, 6011-6016, 6018,6019, 6021-6025	G2090027	Si	1SS53				CAPACITOR		
				C6015,6023,6090	K00179001	Ceramic	50WV SL	0.5pF (DD104SL0R5C50V)	
D6001,6002,6005	G2090107	Varactor	1T25	C6061	K00172010	" "	" "	1pF (DD104SL010C50V)	
D6010,6017	G2090003	Si	V06B						
				C6086	K02179001	" "	" CH	1pF (DD104CK010C50V)	
		CRYSTAL		C6077	K02179003	" "	" "	2pF (DD104CK020C50V)	
X6001	H0102506	HC-18/U	8.5333MHz						
X6002 (Model A,B,C)	H0102505	HC-18/U3P	57.4333MHz	C6088	K00172020	" "	" SL	2pF (DD104SL020C50V)	
X6002 (Model X)	H0102518	"	59.1000MHz	C6114	K02179004	" "	" CH	3pF (DD104CH030C50V)	
		THERMISTOR		C6020	K02172040	" "	" "	4pF (DD104CH040C50V)	
TH6001,6002	G9090008	31D26							
				C6011	K02172050	" "	" "	5pF (DD104CH050C50V)	
		POSISTOR		C6007,6081	K02173060	" "	" "	6pF (DD104CH060D50V)	
PTH6001	G9090019	PTH-2928							
				C6002,6078*	K02173070	" "	" "	7pF (DD104CH070D50V)	
		RESISTOR							
R6011	J01215100	Carbon film	1/8W TJ	10Ω	C6078	K05173080	" "	" RH	8pF (DD104RH080D50V)
R6013	J01215150	" "	" "	" "	" "	" "	" "	" "	" "
R6005,6007,6017, 6039,6041,6053	J02245560	" "	1/4W SJ	56Ω	C6006,6080	K02173090	" "	" CH	9pF (DD104CH090D50V)
R6024,6025,6058, 6063,6066	J02245101	" "	" "	100Ω	C6004,6005	K06173100	" "	" UJ	10pF (DD104UJ100D50V)
R6038	J01245101	" "	" TJ	100Ω	C6068	K00173100	" "	" SL	10pF (DD104SL100D50V)
R6003	J01215101	" "	1/8W TJ	100Ω					
R6048	J00215101	" "	1/8W VJ	100Ω	C6003,6079	K02175120	" "	" CH	12pF (DD104CH120J50V)
R6010	J02245221	" "	1/4W SJ	220Ω					
R6012,6014	J01215271	" "	1/8W TJ	270Ω		K05175120	" "	" RH	12pF (DD104RH120J50V)
R6047	J00215331	" "	" VJ	330Ω					
R6002	J02245331	" "	1/4W SJ	330Ω	C6041	K00175150	" "	" SL	15pF (DD104SL150J50V)
R6027	J02245391	" "	" "	390Ω					
R6085	J01245471	" "	" TJ	470Ω	C6060,6062	K05175150	" "	" RH	15pF (DD104RH150J50V)
R6019	J02245681	" "	" SJ	680Ω					
R6023,6042,6044, 6054,6057,6059	J02245102	" "	" "	1kΩ	C6008,6082	K02175180	" "	" CH	18pF (DD104CH180J50V)

(* 440-450MHz)
(430MHz MODULE)

21-28 MHz Module (OPTION)			R5061,5065,5070	J02245560	Carbon film 1/4W SJ 56Ω
Symbol No.	Part No.	Description	R5073,5083,5087	J02245680	" " " " 68Ω
*** 21-28 MHz RF UNIT ***			R5076	J02245820	" " " " 82Ω
	F2539000	Printed Circuit Board	R5012,5015,5017, 5030,5069,5077	J02245101	" " " " 100Ω
	C025390A	PCB with components			
			R5064,5099	J01245101	" " " " TJ 100Ω
			R5050	J02245151	" " " " SJ 150Ω
		IC	R5008	J02245221	" " " " 220Ω
Q5021	G1090080	μPC78L08	R5078	J02245271	" " " " 270Ω
Q5006	G2090135	ND487C2-3R	R5018,5042,5044	J02245471	" " " " 470Ω
			R5084,5088	J02245681	" " " " 680Ω
			R5082	J02245751	" " " " 750Ω
		FET	R5023-5026,5093	J02245102	" " " " 1kΩ
Q5007	G3801250	2SK125	R5031	J02245152	" " " " 1.5kΩ
Q5008,5011,5012	G3802410G	2SK241GR	R5011,5021,5022, 5027,5033,5034, 5036,5038,5040, 5043,5052,5056, 5057,5066,5072, 5074	J02245222	" " " " 2.2kΩ
Q5009,5010	G3802410Y	2SK241Y			
Q5024	G4800510C	3SK51-03			
Q5005	G4800740L	3SK74L			
			R5003,5014	J02245332	" " " " 3.3kΩ
		TRANSISTOR	R5035,5037,5097	J02245472	" " " " 4.7kΩ
Q5020,5022	G3107331Q	2SA733AQ	R5007	J02245562	" " " " 5.6kΩ
Q5001,5002	G3304600B	2SC460B	R5047,5091,5098	J02245103	" " " " 10kΩ
Q5003	G3305350B	2SC535B	R5039,5041	J02245153	" " " " 15kΩ
Q5019	G3318150Y	2SC1815GR	R5001,5002,5006, 5059,5060,5063, 5067,5094,5095	J02245223	" " " " 22kΩ
Q5013-5018	G3319730	2SC1973			
Q5004	G3324070	2SC2407			
			R5048,5096	J02245473	" " " " 47kΩ
			R5028,5062	J02245104	" " " " 100kΩ
		DIODE	R5029	J02245225	" " " " 2.2MΩ
D5006,5008,5010, 5012,5031,5032	G2015550	Si 1S1555			
D5001-5005,5007, 5009,5011,5013, 5015-5030,5033, 5038,5039	G2090027	" 1SS53			BLOCK RESISTOR
			RB5001	J40900010	RK1/16 B4R 10kΩx4
					POTENTIOMETER
D5037	G2090211	" V06C	VR5001,5002	J51752101	RGS6FAN 101 100ΩB
D5034-5036	G2090118	Schottky barrier 1SS97	VR5003	J51745102	H0651A007-1KB 1kΩB
D5014	G9090007	Varistor MV12	VR5006	J51745103	H0651A013-10KB 10kΩB
			VR5005	J51745223	H0651A015-22KB 22kΩB
			VR5004	J51745473	H0651A017-47KB 47kΩB
		CRYSTAL			
X5001	H0102546	HC-18/U3P 57.065MHz			
					CAPACITOR
			C5055	K00172020	Ceramic disc 50WV SL 2pF (DD104SL020C50V)
XF5001	H1102076	XF-46JX	C5098,5100,5105	K00172040	" " " " 4pF (DD104SL040C50V)
			C5061	K00173060	" " " " 6pF (DD104SL060D50V)
		TERMISTOR	C5101,5104,5106	K00173080	" " " " 8pF (DD104SL080D50V)
TH5001	G9090008	31D26			
TH5002	G9090026	22D47			
TH5003	G9090020	21D27	C5063,5064	K02173080	" " " " CH 8pF (DD104CH080D50V)
TH5004,5005	G9090001	SDT250			
			C5052	K00173100	" " " " SL 10pF (DD104SL100D50V)
		RESISTOR	C5102,5103	K00175120	" " " " 12pF (DD104SL120J50V)
R5085,5086,5089, 5090	J02245229	Carbon film 1/4W SJ 2.2Ω	C5099	K00175150	" " " " 15pF (DD104SL150J50V)
R5019,5075,5079, 5080	J02245470	" " " " 47Ω	C5008,5051	K05175150	" " " " RH 15pF (DD104RH150J50V)
R5004,5005,5009, 5011,5013,5016, 5020,5021,5032, 5045,5046,5049, 5051,5055,5058	J02245560	" " " " 56Ω	C5134,5135	K00175180	" " " " SL 18pF (DD104SL180J50V)

(21-28 MHz MODULE)

C5067	K00175220	Ceramic disc 50WV SL 22pF (DD104SL220J50V)	T5012,5013	L0021165	
			T5015-5018	L0021161	
C5009,5010	K00175390	" " " SL 39pF (DD104SL390J50V)	T5019-5021	L0021125A	
			T5022	L0021379	
C5047,5050,5056, 5068,5092,5133	K00175470	" " " " 47pF (DD104SL470J50V)	T5023	L0190007	
			T5024	L0021378	
C5001	K06175470	" " " UJ 47pF (DD104UJ470J50V)			
C5002	K06179009	" " " UJ 56pF (DD104UJ560J50V)			INDUCTOR
			L5001	L0020533	
C5018,5041,5042	K00175820	" " " SL 82pF (DD104SL820J50V)	L5003	L0021384	
			L5005,5006	L0021382	
C5071,5073	K00179013	" " " " 91pF (DD105SL910J50V)	L5010	L0021381	
			L5013,5014	L0021383	
C5016,5019,5072, 5082	K00175121	" " " " 120pF (DD105SL121J50V)	L5018	L0021388	
			L5019	L0021387	
C5005,5011,5034, 5059,5062,5074, 5079,5111,5129, 5137	K10176102	" " " B 0.001 μ F (DD104B102K50V)	L5002	L1190108	FL3H-R68M 0.68 μ H
			L5004,5007	L1190029	FL5H-470K 47 μ H
			L5008,5009,5015, 5016	L1190014	FL4H-100K 10 μ H
C5132	K10176222	" " " " 0.0022 μ F (DD106B222K50V)	L5011,5012	L1190113	FL3H-R22M 0.22 μ H
			L5017	L1190008	FL4H-2R2M 2.2 μ H
C5003,5004,5006, 5007,5013,5031, 5057,5076,5078, 5085,5089,5094, 5107,5108,5110, 5114-5116,5121, 5122,5125-5128, 5136,5138-5143	K13179008	" " " F 0.01 μ F (DD106F103Z50V)	L5020	L1190138	LAL04NA100K 10 μ H
			L5021	L1190090	LAL04NA102K 1mH
					RELAY
			RL5001	M1190006	FBR221D012M
C5012,5014,5017, 5020,5065,5066, 5070,5081,5083, 5086,5087	K13179010	" " " " 0.022 μ F (DD108F223Z50V)			MINI CONNECTOR
			J5001	P0090189	5049-11A
			J5002	P0090042	5048-05A
			J5003	P0090054	5048-07A
			J5004	P0090050	5048-04A
			J5005-5007	P1090255	TMP-JA
				Q5000036	TP TERMINAL
				Q5000037	TP-G
					TP-H
C5095	K70127225	Tantalum 16WV 2.2 μ F (CS15E1C2R2M)			
C5128	K40179002	Electrolytic 50WV 0.1 μ F (ECE-A1HK0R1 50V)			
				R0100590	HEAT SINK
C5021,5023,5025, 5027,5117	K40179013	" " " 1 μ F (50RE1)			
C5015,5084,5124	K40129004	" " 16WV 10 μ F (16RE10)			
C5088	K40089001	" " 6.3WV 100 μ F (6.3RE100)			
					*** 21-28 MHz PLL UNIT ***
C5097	K40129020	" " 16WV 100 μ F (16RC100)		F2540000	Printed Circuit Board
				C025400A	PCB with components
C5109	K40129021	" " " 1000 μ F (16RS102S)			
					IC
			Q6034	G1090088	MC14028B
		TRANSFORMER	Q6031	G1090053	MC14081B
T5001,5014	L0021358		Q6033	G1090343	MC14094B
T5002,5003	L0021313		Q6032	G1090312	MC14504B
T5004	L0021312		Q6036	G1090496	MC145143P
T5005	L0021311		Q6012	G1090012	SN16913P
T5006,5007	L0021321		Q6008	G1090062	SN76514N
T5008	L0021320		Q6035	G1090247	TC9122P
T5009	L0021319		Q6037	G1090084	μ PC78L05
T5010,5011	L0021351		Q6039	G1090080	μ PC78L08

(21-28 MHz MODULE)

		FET	R6045,6061-6064, 6068,6069,6071, 6086,6088,6089	J02245104	Carbon film 1/4W SJ 100k Ω
Q6006	G3802410G G3803590	2SK241GR (or 2SK359)			
			R6065,6066	J02245224	" " " " 220k Ω
			R6049	J02245334	" " " " 330k Ω
		TRANSISTOR	R6099	J01215105	" " 1/8W TJ 1M Ω
Q6023,6024	G3107331Q	2SA733AQ			
Q6001-6004	G3110050K	2SA1005K			BLOCK RESISTOR
Q6010,6011,6026	G3304600B	2SC460B	RB6001	J40900039	RA1/16K4R 100k Ω x4
Q6025	G3304960Y	2SC496Y			CAPACITOR
Q6009	G3305350B	2SC535B	C6049,6058	K00172010	Ceramic disc 50WV SL 1pF (DD104SL010C50V)
Q6013-6018,6022, 6027-6030	G3309451P	2SC945AP	C6003	K00172020	" " " " 2pF (DD104SL020C50V)
Q6019-6021	G3318150G	2SC1815GR	C6008	K00172030	" " " " 3pF (DD104SL030C50V)
Q6005	G3319230O	2SC1923-O			
Q6007	G3324580Y	2SC2458Y			
Q6038	G3090005	MPS-A13	C6002,6007,6012, 6017,6023,6028	K06172030	" " " UJ 3pF (DD104UJ030C50V)
			C6129	K06172040	" " " " 4pF (DD106UJ040C50V)
		DIODE			
D6005-6021	G2090027	Si 1SS53	C6011	K02172040	" " " CH 4pF (DD104CH040C50V)
D6022	G2090211	" V06C			
D6001-6004	G2090271	Varactor 1T33	C6016	K02172050	" " " " 5pF (DD104CH050C50V)
		CRYSTAL	C6013	K00173060	" " " SL 6pF (DD104SL060D50V)
X6001	H0102547	HC-18/U3P 58.4685MHz			
X6002	H0102557	HC-18/U 8.00MHz	C6018,6070	K00173080	" " " " 8pF (DD104SL080D50V)
		RESISTOR	C6001	K02173080	" " " CH 8pF (DD104CH080D50V)
R6006,6010,6015, 6020	J02245100	Carbon film 1/4W SJ 10 Ω	C6009	K02173090	" " " " 9pF (DD104CH090D50V)
R6032,6037,6044, 6050,6091	J02245560	" " " " 56 Ω	C6065,6067	K00175120	" " " SL 10pF (DD104SL120J50V)
R6004,6009,6014, 6019,6021,6026, 6030,6042,6046, 6055,6060,6077	J02245101	" " " " 100 Ω	C6047,6055	K05173100	" " " RH 10pF (DD104RH100D50V)
R6079	J01245221	" " " TJ 220 Ω	C6050,6051,6057	K05175120	" " " " 12pF (DD104RH120J50V)
R6028	J02245331	" " " SJ 330 Ω		K00175120	" " " SL 12pF (DD104SL120J50V)
R6023,6025,6031	J02245471	" " " " 470 Ω			
R6095	J02245561	" " " " 560 Ω	C6048	K00175150	" " " " 15pF (DD104SL150J50V)
R6048	J02245681	" " " " 680 Ω			
R6041,6043,6051, 6054,6056,6059	J02245102	" " " " 1k Ω	C6005,6010,6015, 6020	K02175150	" " " CH 15pF (DD104CH150J50V)
R6029,6092	J02245152	" " " " 1.5k Ω	C6064	K00175180	" " " SL 18pF (DD104SL180J50V)
R6033,6038,6093, 6094	J02245222	" " " " 2.2k Ω	C6069	K00175270	" " " " 27pF (DD104SL270J50V)
R6022,6047,6096	J02245332	" " " " 3.3k Ω	C6026,6027	K00175330	" " " " 33pF (DD104SL330J50V)
R6036,6085	J02245472	" " " " 4.7k Ω			
R6040,6052,6057	J02245562	" " " " 5.6k Ω	C6029,6038	K06175330	" " " UJ 33pF (DD104UJ330J50V)
R6024,6027,6078, 6087	J02245103	" " " " 10k Ω			
R6089	J02245123	" " " " 12k Ω	C6109	K06175390	" " " " 39pF (DD104UJ390J50V)
R6090	J02245153	" " " " 15k Ω			
R6001,6006,6011, 6016	J01215223	" " 1/8W TJ 22k Ω	C6037,6128	K06175470	" " " " 47pF (DD104UJ470J50V)
R6034,6035,6039, 6053,6058,6067, 6070,6072-6075, 6080-6084,6098	J02245223	" " 1/4W SJ 22k Ω	C6052,6078,6082	K00175470	" " " SL 47pF (DD104SL470J50V)
			C6032,6035,6068	K00175560	" " " " 56pF (DD104SL560J50V)
R6002,6003,6007, 6008,6012,6013, 6017,6018	J02245333	" " " " 33k Ω	C6066	K00175680	" " " " 68pF (DD104SL680J50V)
R6076	J02245393	" " " " 39k Ω	C6034,6092	K00175101	" " " " 100pF (DD105SL101J50V)
R6077	J02245563	" " " " 56k Ω			

(21-28 MHz MODULE)

			*** 21-28 MHz MAIN CHASSIS ***		
			Symbol No.	Part No.	Description
C7007	K00175470	Ceramic disc 50WV SL 47pF (DD104SL470J50V)			
C7001	K00175820	" " " " 82pF (DD104SL820J50V)	Q7501	G1090294	IC µPC7808H
C7004,7006	K00179013	" " " " 91pF (DD105SL910J50V)		Q9000192	Thermal conductor
C7014	K00175121	" " " " 120pF (DD106SL121J50V)		S5000065	Washer
C7003	K00175151	" " " " 150pF (DD106SL151J50V)			
C7005	K00175181	" " " " 180pF (DD106SL181J50V)			
C7022,7031-7033, 7035	K10176102	" " " " B 0.001µF (DD104B102K50V)			
C7026	K13179008	" " " " F 0.01µF (DD106F103Z50V)			
C7011,7012,7018, 7021,7023,7025, 7027	K13179009	" " " " " 0.047µF (DD110F473Z50V)			
C7016,7017	K50177154	Mylar 50WV 0.15µF (50F2U154M)			
C7015,7019	K70120007	Tantalum 16WV 6.8µF (489D685X0016C1)			
C7028	K40109005	Electrolytic 10WV 10µF (ECE-A1AK100)			
C7024	K40089002	" 6.3WV 33µF (ECE-A0JK330)			
C7020	K40129007	" 16WV 100µF (16RE100)			
		TRANSFORMER			
T7001	L0021377				
T7002	L0021376				
		INDUCTOR			
L7001	L1020015				
L7002	L1020032				
L7003	L0021386				
L7004	L0020824				
L7005	L0021385				
		RELAY			
RL7001	M1190002	FBR211AD012M			
		TP TERMINAL			
	Q5000036	TP-G			
		RECEPTACLE			
J7001	P1090192	FM-MR			
J7002	P1090005	S-G8050			
	Q9000192	THERMAL CONDUCTOR for Q7001			
	R4083841A	HEAT SINK			
	R0100540A	HEAT SINK COVER			

FOR SERVICE MANUALS
CONTACT:
MAURITRON TECHNICAL SERVICES
www.mauritron.co.uk
TEL: 01844 - 351694
FAX: 01844 - 352554

(21-28 MHz MODULE)

MEMO